



ICAO

International Standards  
and Recommended Practices

# Annex 16 to the Convention on International Civil Aviation

## Environmental Protection

Volume I — Aircraft Noise  
Eighth Edition, July 2017



This edition supersedes, on 1 January 2018, all previous editions of Annex 16, Volume I.

For information regarding the applicability of the Standards and Recommended Practices, see the Foreword.

INTERNATIONAL CIVIL AVIATION ORGANIZATION





| ICAO

International Standards  
and Recommended Practices

# Annex 16 to the Convention on International Civil Aviation

## Environmental Protection

Volume I — Aircraft Noise  
Eighth Edition, July 2017

This edition supersedes, on 1 January 2018, all previous editions of Annex 16, Volume I.

For information regarding the applicability of the Standards and Recommended Practices, see the Foreword.

INTERNATIONAL CIVIL AVIATION ORGANIZATION

Published in separate English, Arabic, Chinese, French, Russian  
and Spanish editions by the  
INTERNATIONAL CIVIL AVIATION ORGANIZATION  
999 Robert-Bourassa Boulevard, Montréal, Quebec, Canada H3C 5H7

For ordering information and for a complete listing of sales agents  
and booksellers, please go to the ICAO website at [www.icao.int](http://www.icao.int).

*First edition 1981*  
*Seventh edition 2014*  
*Eighth edition 2017*

***Annex 16 — Environmental Protection***  
***Volume I — Aircraft Noise***

Order Number: AN16-1  
ISBN 978-92-9258-260-9

© ICAO 2017

All rights reserved. No part of this publication may be reproduced, stored in a  
retrieval system or transmitted in any form or by any means, without prior  
permission in writing from the International Civil Aviation Organization.





# TABLE OF CONTENTS

	<i>Page</i>
Foreword.....	(xi)
<b>Part I. DEFINITIONS, NOMENCLATURE: SYMBOLS AND UNITS.....</b>	<b>I-1</b>
<b>Part II. AIRCRAFT NOISE CERTIFICATION.....</b>	<b>II-1-1</b>
CHAPTER 1. Administration.....	II-1-1
CHAPTER 2. Subsonic jet aeroplanes — Application for Type Certificate submitted before 6 October 1977.....	II-2-1
2.1 Applicability.....	II-2-1
2.2 Noise evaluation measure.....	II-2-1
2.3 Noise measurement points.....	II-2-2
2.4 Maximum noise levels.....	II-2-2
2.5 Trade-offs.....	II-2-3
2.6 Test procedures.....	II-2-3
CHAPTER 3.	
1. Subsonic jet aeroplanes — Application for Type Certificate submitted on or after 6 October 1977 and before 1 January 2006	
2. Propeller-driven aeroplanes over 8 618 kg — Application for Type Certificate submitted on or after 1 January 1985 and before 1 January 2006.....	II-3-1
3.1 Applicability.....	II-3-1
3.2 Noise measurements.....	II-3-1
3.3 Noise measurement points.....	II-3-2
3.4 Maximum noise levels.....	II-3-2
3.5 Trade-offs.....	II-3-3
3.6 Noise certification reference procedures.....	II-3-3
3.7 Test procedures.....	II-3-6
CHAPTER 4.	
1. Subsonic jet aeroplanes and propeller-driven aeroplanes with maximum certificated take-off mass 55 000 kg and over — Application for Type Certificate submitted on or after 1 January 2006 and before 31 December 2017	
2. Subsonic jet aeroplanes with maximum certificated take-off mass less than 55 000 kg — Application for Type Certificate submitted on or after 1 January 2006 and before 31 December 2020	
3. Propeller-driven aeroplanes with maximum certificated take-off mass over 8 618 kg and less than 55 000 kg — Application for Type Certificate submitted on or after 1 January 2006 and before 31 December 2020.....	II-4-1

	<i>Page</i>
4.1 Applicability .....	II-4-1
4.2 Noise measurements .....	II-4-2
4.3 Reference noise measurement points .....	II-4-2
4.4 Maximum noise levels .....	II-4-2
4.5 Noise certification reference procedures .....	II-4-3
4.6 Test procedures .....	II-4-3
4.7 Recertification .....	II-4-3
 CHAPTER 5. Propeller-driven aeroplanes over 8 618 kg — Application for Type Certificate submitted before 1 January 1985 .....	 II-5-1
5.1 Applicability .....	II-5-1
5.2 Noise measurements .....	II-5-2
5.3 Noise measurement points .....	II-5-2
5.4 Maximum noise levels .....	II-5-2
5.5 Trade-offs .....	II-5-3
5.6 Noise certification reference procedures .....	II-5-3
5.7 Test procedures .....	II-5-5
 CHAPTER 6. Propeller-driven aeroplanes not exceeding 8 618 kg — Application for Type Certificate submitted before 17 November 1988 .....	 II-6-1
6.1 Applicability .....	II-6-1
6.2 Noise evaluation measure .....	II-6-1
6.3 Maximum noise levels .....	II-6-1
6.4 Noise certification reference procedures .....	II-6-2
6.5 Test procedures .....	II-6-2
 CHAPTER 7. Propeller-driven STOL aeroplanes .....	 II-7-1
 CHAPTER 8. Helicopters .....	 II-8-1
8.1 Applicability .....	II-8-1
8.2 Noise evaluation measure .....	II-8-1
8.3 Reference noise measurement points .....	II-8-1
8.4 Maximum noise levels .....	II-8-2
8.5 Trade-offs .....	II-8-3
8.6 Noise certification reference procedures .....	II-8-3
8.7 Test procedures .....	II-8-5
 CHAPTER 9. Installed auxiliary power units (APU) and associated aircraft systems during ground operations .....	 II-9-1
 CHAPTER 10. Propeller-driven aeroplanes not exceeding 8 618 kg — Application for Type Certificate or certification of Derived Version submitted on or after 17 November 1988 .....	 II-10-1
10.1 Applicability .....	II-10-1
10.2 Noise evaluation measure .....	II-10-1
10.3 Reference noise measurement points .....	II-10-2
10.4 Maximum noise levels .....	II-10-2



	<i>Page</i>
10.5 Noise certification reference procedures .....	II-10-2
10.6 Test procedures .....	II-10-4
CHAPTER 11. Helicopters not exceeding 3 175 kg maximum certificated take-off mass .....	II-11-1
11.1 Applicability .....	II-11-1
11.2 Noise evaluation measure .....	II-11-1
11.3 Reference noise measurement points .....	II-11-1
11.4 Maximum noise level.....	II-11-2
11.5 Noise certification reference procedure .....	II-11-2
11.6 Test procedures .....	II-11-3
CHAPTER 12. Supersonic aeroplanes.....	II-12-1
12.1 Supersonic aeroplanes — application for Type Certificate submitted before 1 January 1975 .....	II-12-1
12.2 Supersonic aeroplanes — application for Type Certificate submitted on or after 1 January 1975 .....	II-12-1
CHAPTER 13. Tilt-rotors.....	II-13-1
13.1 Applicability .....	II-13-1
13.2 Noise evaluation measure .....	II-13-1
13.3 Noise measurement reference points.....	II-13-1
13.4 Maximum noise levels .....	II-13-2
13.5 Trade-offs.....	II-13-2
13.6 Noise certification reference procedures .....	II-13-3
13.7 Test procedures .....	II-13-5
CHAPTER 14.	
1. Subsonic jet aeroplanes and propeller-driven aeroplanes with maximum certificated take-off mass 55 000 kg and over — Application for Type Certificate submitted on or after 31 December 2017	
2. Subsonic jet aeroplanes with maximum certificated take-off mass less than 55 000 kg — Application for Type Certificate submitted on or after 31 December 2020	
3. Propeller-driven aeroplanes with maximum certificated take-off mass over 8 618 kg and less than 55 000 kg — Application for Type Certificate submitted on or after 31 December 2020.....	II-14-1
14.1 Applicability .....	II-14-1
14.2 Noise measurements .....	II-14-2
14.3 Reference noise measurement points .....	II-14-2
14.4 Maximum noise levels .....	II-14-2
14.5 Noise certification reference procedures .....	II-14-3
14.6 Test procedures .....	II-14-3
14.7 Recertification.....	II-14-3
<b>Part III. NOISE MEASUREMENT FOR MONITORING PURPOSES.....</b>	<b>III-1</b>
<b>Part IV. ASSESSMENT OF AIRPORT NOISE.....</b>	<b>IV-1</b>
<b>Part V. BALANCED APPROACH TO NOISE MANAGEMENT .....</b>	<b>V-1</b>

## APPENDICES

APPENDIX 1. Evaluation method for noise certification of subsonic jet aeroplanes — Application for Type Certificate submitted before 6 October 1977 .....	APP 1-1
1. Introduction .....	APP 1-1
2. Noise certification test and measurement conditions .....	APP 1-1
3. Measurement of aeroplane noise received on the ground .....	APP 1-3
4. Calculation of effective perceived noise level from measured noise data .....	APP 1-6
5. Reporting of data to the certificating authority and correcting measured data .....	APP 1-16
6. Nomenclature .....	APP 1-18
7. Mathematical formulation of noy tables .....	APP 1-24
8. Sound attenuation in air .....	APP 1-28
9. Detailed correction procedures .....	APP 1-34
APPENDIX 2. Evaluation method for noise certification of:	
1. Subsonic jet aeroplanes — Application for Type Certificate submitted on or after 6 October 1977	
2. Propeller-driven aeroplanes over 8 618 kg — Application for Type Certificate submitted on or after 1 January 1985	
3. Helicopters	
4. Tilt-rotors .....	APP 2-1
1. Introduction .....	APP 2-1
2. Noise certification test and measurement conditions .....	APP 2-1
3. Measurement of aircraft noise received on the ground .....	APP 2-6
4. Calculation of effective perceived noise level from measured noise data .....	APP 2-15
5. Reporting of data to the certificating authority .....	APP 2-22
6. Reserved .....	APP 2-26
7. Sound attenuation in air .....	APP 2-26
8. Adjustment of aircraft flight test results .....	APP 2-27
APPENDIX 3. Evaluation method for noise certification of propeller-driven aeroplanes not exceeding 8 618 kg — Application for Type Certificate submitted before 17 November 1988 .....	APP 3-1
1. Introduction .....	APP 3-1
2. Noise certification test and measurement conditions .....	APP 3-1
3. Measurement of aeroplane noise received on the ground .....	APP 3-2
4. Reporting of data to the certificating authority and correction of measured data .....	APP 3-4
APPENDIX 4. Evaluation method for noise certification of helicopters not exceeding 3 175 kg maximum certificated take-off mass .....	APP 4-1
1. Introduction .....	APP 4-1
2. Noise certification test and measurement conditions .....	APP 4-1
3. Noise unit definition .....	APP 4-3
4. Measurement of helicopter noise received on the ground .....	APP 4-3
5. Adjustment to test results .....	APP 4-5
6. Reporting of data to the certificating authority and validity of results .....	APP 4-6

	<i>Page</i>
APPENDIX 5. Monitoring aircraft noise on and in the vicinity of aerodromes .....	APP 5-1
1. Introduction .....	APP 5-1
2. Definition .....	APP 5-1
3. Measurement equipment .....	APP 5-1
4. Field equipment installation .....	APP 5-4
APPENDIX 6. Evaluation method for noise certification of propeller-driven aeroplanes not exceeding 8 618 kg — Application for Type Certificate or certification of Derived Version submitted on or after 17 November 1988 .....	APP 6-1
1. Introduction .....	APP 6-1
2. Noise certification test and measurement conditions .....	APP 6-1
3. Noise unit definition.....	APP 6-2
4. Measurement of aeroplane noise received on the ground .....	APP 6-3
5. Adjustment to test results .....	APP 6-5
6. Reporting of data to the certifying authority and validity of results.....	APP 6-8

**ATTACHMENTS**

ATTACHMENT A. Equations for the calculation of maximum permitted noise levels as a function of take-off mass.....	ATT A-1
ATTACHMENT B. Guidelines for noise certification of propeller-driven STOL aeroplanes .....	ATT B-1
ATTACHMENT C. Guidelines for noise certification of installed auxiliary power units (APU) and associated aircraft systems during ground operation.....	ATT C-1
ATTACHMENT D. Guidelines for evaluating an alternative method of measuring helicopter noise during approach .....	ATT D-1
ATTACHMENT E. Applicability of Annex 16 noise certification Standards for propeller-driven aeroplanes ....	ATT E-1
ATTACHMENT F. Guidelines for noise certification of tilt-rotors .....	ATT F-1
ATTACHMENT G. Guidelines for the administration of noise certification documentation .....	ATT G-1
ATTACHMENT H. Guidelines for obtaining helicopter noise data for land-use planning purposes .....	ATT H-1



# FOREWORD

## Historical background

Standards and Recommended Practices for Aircraft Noise were first adopted by the Council on 2 April 1971 pursuant to the provisions of Article 37 of the Convention on International Civil Aviation (Chicago, 1944) and designated as Annex 16 to the Convention. The Annex was developed in the following manner:

The Sixteenth Session of the Assembly, Buenos Aires, September 1968, adopted the following Resolution:

*A16-3: Aircraft Noise in the Vicinity of Airports*

*Whereas* the problem of aircraft noise is so serious in the vicinity of many of the world's airports that public reaction is mounting to a degree that gives cause for great concern and requires urgent solution;

*Whereas* the noise that concerns the public and civil aviation today is being caused by increase in traffic of existing aircraft;

*Whereas* the introduction of future aircraft types could increase and aggravate this noise unless action is taken to alleviate the situation;

*Whereas* the Fifth Air Navigation Conference of ICAO held in Montreal in November 1967 made certain recommendations, based on the principal conclusions of the International Conference on the Reduction of Noise and Disturbance Caused by Civil Aircraft ("The London Noise Conference") held in London in November 1966, with the object of reaching international solutions to the problem through the machinery of ICAO; and

*Whereas* the Assembly has noted the action being taken by the Council, in consultation with States and the appropriate international organizations, to give effect to the recommendations of the Fifth Air Navigation Conference, as reported to the Assembly by the Secretary General;

THE ASSEMBLY RESOLVES to instruct the Council:

- 1) to call an international conference within the machinery of ICAO as soon as practicable, bearing in mind the need for adequate preparation, to consider the problem of aircraft noise in the vicinity of airports;
- 2) to establish international specifications and associated guidance material relating to aircraft noise;
- 3) to include, in appropriate existing Annexes and other relevant ICAO documents and possibly in a separate Annex on noise, such material as the description and methods of measurement of aircraft noise and suitable limitations on the noise caused by aircraft that is of concern to communities in the vicinity of airports; and
- 4) to publish such material on a progressive basis, commencing at the earliest possible time.

In response to Assembly Resolution A16-3, a Special Meeting on Aircraft Noise in the Vicinity of Aerodromes was convened in Montréal (November–December 1969) to examine the following aspects related to the problems of aircraft noise:

- a) procedures for describing and measuring aircraft noise;
- b) human tolerance to aircraft noise;
- c) aircraft noise certification;

- d) criteria for establishment of aircraft noise abatement operating procedures;
- e) land-use control; and
- f) ground run-up noise abatement procedures.

Based on the recommendations of the Special Meeting on Aircraft Noise in the Vicinity of Aerodromes, draft International Standards and Recommended Practices for Aircraft Noise were developed and, after amendment following the usual consultation with the Contracting States of the Organization, were adopted by the Council to form the text of this Annex.

With the development of Standards and Recommended Practices dealing with the control of aircraft engine emissions, it was felt that all provisions relating to environmental aspects of aviation should be included in a single document. Accordingly, as part of the Resolution adopting Amendment 5, it was agreed that Annex 16 should be retitled as “Environmental Protection” and Volume I of the Annex should contain the existing provisions (Third Edition) of Annex 16 — *Aircraft Noise* as amended by Amendment 5, and Volume II should contain the provisions related to aircraft engine emissions.

Several Assembly and Council sessions have addressed the issue of aircraft noise since the Special Meeting on Aircraft Noise in the Vicinity of Aerodromes, focusing on the various aspects related to the problems of aircraft noise identified at the Special Meeting. The Thirty-third Session of the Assembly, Montréal, 25 September to 5 October 2001, in Resolution A33-7, issued a Consolidated Statement of Continuing ICAO Policies and Practices Related to Environmental Protection to, in significant part, “incorporate new ICAO policies and guidance material regarding aircraft noise” and to reflect the concept of a “balanced approach” to noise management, which had developed over time.

As defined in Appendix C to Assembly Resolution A33-7, the balanced approach to noise management consists of identifying the noise problem at an airport and then analysing the various measures available to reduce noise through the exploration of four principal elements, namely reduction at source, land-use planning and management, noise abatement operational procedures and operating restrictions, with the goal of addressing the noise problem in the most cost-effective manner.

In addition to providing additional detail on the balanced approach concept, Assembly Resolution A33-7 urges States to adopt a balanced approach to noise management.

The principal elements of the balanced approach are addressed in various places in Annex 16, Volume I, and in guidance adopted by ICAO. Reduction of noise at source through aircraft noise certification is addressed in Annex 16, Volume I, Part II. References to the other elements of the balanced approach are contained in Part V.

Table A shows the origin of amendments to the Annex over time together with a list of the principal subjects involved and the dates on which the Annex and the amendments were adopted by the Council, when they became effective and when they became applicable.

### Applicability

Part I of Volume I of Annex 16 contains definitions and Part II contains Standards, Recommended Practices and guidelines for noise certification applicable to the classification of aircraft specified in individual chapters of that part, where such aircraft are engaged in international air navigation.

*Note.— Chapters 2, 3, 4, 5 and 14 exclude aeroplanes having short take-off and landing (STOL) capabilities which, pending the development by ICAO of a suitable definition, are described for the purpose of this Annex as those requiring a runway (with no stopway or clearway) of 610 m or less at the maximum certificated mass for airworthiness.*

Parts III, IV and V of Volume I of Annex 16 contain Standards and Recommended Practices and guidance material for use by States with a view to promoting uniformity in measurement of noise for monitoring purposes, assessing noise around airports, and regarding the balanced approach to noise management.

### Action by Contracting States

*Notification of differences.* The attention of Contracting States is drawn to the obligation imposed by Article 38 of the Convention by which Contracting States are required to notify the Organization of any differences between their national regulations and practices and the International Standards contained in this Annex and any amendments thereto. Contracting States are invited to extend such notification to any differences from the Recommended Practices contained in this Annex, and any amendments thereto, when the notification of such differences is important for the safety of air navigation. Further, Contracting States are invited to keep the Organization currently informed of any differences which may subsequently occur, or of the withdrawal of any differences previously notified. A specific request for notification of differences will be sent to Contracting States immediately after the adoption of each amendment to this Annex.

The attention of States is also drawn to the provisions of Annex 15 related to the publication of differences between their national regulations and practices and the related ICAO Standards and Recommended Practices through the Aeronautical Information Service, in addition to the obligation of States under Article 38 of the Convention.

*Use of the Annex text in national regulations.* The Council, on 13 April 1948, adopted a resolution inviting the attention of Contracting States to the desirability of using in their own national regulations, as far as is practicable, the precise language of those ICAO Standards that are of a regulatory character and also of indicating departures from the Standards, including any additional national regulations that were important for the safety or regularity of international air navigation. Wherever possible, the provisions of this Annex have been written in such a way as to facilitate incorporation, without major textual changes, into national legislation.

### Status of Annex components

An Annex is made up of the following component parts, not all of which, however, are necessarily found in every Annex; they have the status indicated:

1.— *Material comprising the Annex proper:*

- a) *Standards and Recommended Practices* adopted by the Council under the provisions of the Convention. They are defined as follows:

*Standard:* Any specification for physical characteristics, configuration, matériel, performance, personnel or procedure, the uniform application of which is recognized as necessary for the safety or regularity of international air navigation and to which Contracting States will conform in accordance with the Convention; in the event of impossibility of compliance, notification to the Council is compulsory under Article 38.

*Recommended Practice:* Any specification for physical characteristics, configuration, matériel, performance, personnel or procedure, the uniform application of which is recognized as desirable in the interest of safety, regularity or efficiency of international air navigation, and to which Contracting States will endeavour to conform in accordance with the Convention.

- b) *Appendices* comprising material grouped separately for convenience but forming part of the Standards and Recommended Practices adopted by the Council.
- c) *Provisions* governing the applicability of the Standards and Recommended Practices.

- d) *Definitions* of terms used in the Standards and Recommended Practices which are not self-explanatory in that they do not have accepted dictionary meanings. A definition does not have an independent status but is an essential part of each Standard and Recommended Practice in which the term is used, since a change in the meaning of the term would affect the specification.
- e) *Tables and Figures* which add to or illustrate a Standard or Recommended Practice and which are referred to therein, form part of the associated Standard or Recommended Practice and have the same status.

2.— *Material approved by the Council for publication in association with the Standards and Recommended Practices:*

- a) *Forewords* comprising historical and explanatory material based on the action of the Council and including an explanation of the obligations of States with regard to the application of the Standards and Recommended Practices ensuing from the Convention and the Resolution of Adoption.
- b) *Introductions* comprising explanatory material introduced at the beginning of parts, chapters or sections of the Annex to assist in the understanding of the application of the text.
- c) *Notes* included in the text, where appropriate, to give factual information or references bearing on the Standards or Recommended Practices in question, but not constituting part of the Standards or Recommended Practices.
- d) *Attachments* comprising material supplementary to the Standards and Recommended Practices, or included as a guide to their application.

#### Selection of language

This Annex has been adopted in six languages — English, Arabic, Chinese, French, Russian and Spanish. Each Contracting State is requested to select one of those texts for the purpose of national implementation and for other effects provided for in the Convention, either through direct use or through translation into its own national language, and to notify the Organization accordingly.

#### Editorial practices

The following practice has been adhered to in order to indicate at a glance the status of each statement: *Standards* have been printed in light face roman; *Recommended Practices* have been printed in light face italics, the status being indicated by the prefix **Recommendation**; *Notes* have been printed in light italics, the status being indicated by the prefix *Note*.

It is to be noted that in the English text the following practice has been adhered to when writing the specifications: Standards employ the operative verb “shall” while Recommended Practices employ the operative verb “should”.

The units of measurement used in this document are in accordance with the International System of Units (SI) as specified in Annex 5 to the Convention on International Civil Aviation. Where Annex 5 permits the use of non-SI alternative units these are shown in parentheses following the basic units. Where two sets of units are quoted it must not be assumed that the pairs of values are equal and interchangeable. It may, however, be inferred that an equivalent level of safety is achieved when either set of units is used exclusively.

Any reference to a portion of this document which is identified by a number includes all subdivisions of that portion.



### Coordination with ISO activity

In the provisions related to certification procedures, extensive use is made of the related specifications developed by the International Organization for Standardization (ISO) and the International Electrotechnical Commission (IEC). In most cases these specifications have been incorporated by direct reference. However, in some cases it has been found necessary to modify the specifications to suit ICAO requirements and in such cases the modified material is included in full in this document. The assistance provided by ISO in the development of detailed specifications is recognized.

**Table A. Amendments to Annex 16**

<i>Amendment</i>	<i>Source(s)</i>	<i>Subject(s)</i>	<i>Adopted Effective Applicable</i>
1st Edition	Special Meeting on Aircraft Noise in the Vicinity of Aerodromes (1969)		2 April 1971 2 August 1971 6 January 1972
1	First Meeting of the Committee on Aircraft Noise	Noise certification of future production and derived versions of subsonic jet aeroplanes and updating of terminology used to describe aircraft weight.	6 December 1972 6 April 1973 16 August 1973
2	Third Meeting of the Committee on Aircraft Noise	Noise certification of light propeller-driven aeroplanes and subsonic jet aeroplanes of 5 700 kg and less maximum certificated take-off weight and guidance on discharge of functions by States in the cases of lease, charter and interchange of aircraft.	3 April 1974 3 August 1974 27 February 1975
3 (2nd Edition)	Fourth Meeting of the Committee on Aircraft Noise	Noise certification Standards for future subsonic jet aeroplanes and propeller-driven aeroplanes, other than STOL aeroplanes, and guidelines for noise certification of future supersonic aeroplanes, propeller-driven STOL aeroplanes and installed APUs and associated aircraft systems when operating on the ground.	21 June 1976 21 October 1976 6 October 1977
4 (3rd Edition)	Fifth Meeting of the Committee on Aircraft Noise	Introduction of a new parameter viz, number of engines in the noise certification Standards for subsonic jet aeroplanes, improvements in detailed test procedures to ensure that the same level of technology is applied to all types of aircraft, and editorial changes to simplify the language and eliminate inconsistencies.	6 March 1978 6 July 1978 10 August 1978
5 (Annex 16, Volume I — 1st Edition)	Sixth Meeting of the Committee on Aircraft Noise	<ol style="list-style-type: none"> <li>1. Annex retitled <i>Environmental Protection</i> and to be issued in two volumes as follows: Volume I — <i>Aircraft Noise</i> (incorporating provisions in the third edition of Annex 16 as amended by Amendment 5) and Volume II — <i>Aircraft Engine Emissions</i>.</li> <li>2. Introduction in Volume I of noise certification Standards for helicopters and for future production of existing SST aeroplanes, updating of guidelines for noise certification of installed APU and associated aircraft systems and editorial amendments including changes to units of measurement to bring the Annex in line with Annex 5 provisions.</li> </ol>	11 May 1981 11 September 1981 26 November 1981
1	Third Meeting of the Operations Panel	Introduction of SARPs for noise abatement operating procedures and transfer of detailed procedures to PANS-OPS, Volume I.	30 March 1983 29 July 1983 24 November 1983
2	Seventh Meeting of the Committee on Aircraft Noise	<ol style="list-style-type: none"> <li>a) improvements in the noise certification procedures; and</li> <li>b) relaxation of maximum noise limits for helicopters.</li> </ol>	6 March 1985 29 July 1985 21 November 1985

<i>Amendment</i>	<i>Source(s)</i>	<i>Subject(s)</i>	<i>Adopted Effective Applicable</i>
3 (Annex 16, Volume I — 2nd Edition)	First Meeting of the Committee on Aviation Environmental Protection; study by the Air Navigation Commission following a recommendation of the Obstacle Clearance Panel	<ul style="list-style-type: none"> <li>a) further improvements in the noise certification procedures;</li> <li>b) introduction of a new Chapter 10 for propeller-driven aeroplanes not exceeding 9 000 kg maximum certificated take-off mass; and</li> <li>c) editorial changes in Part V cross-referencing the relevant provisions in the PANS-OPS (Doc 8168).</li> </ul>	<ul style="list-style-type: none"> <li>4 March 1988</li> <li>31 July 1988</li> <li>17 November 1988</li> </ul>
4 (3rd Edition)	Second Meeting of the Committee on Aviation Environmental Protection; Seventh Meeting of the Committee on Aircraft Noise; and Fifth Meeting of the Operations Panel	<ul style="list-style-type: none"> <li>a) improvements in the noise certification procedures;</li> <li>b) introduction of a new Chapter 11 for light helicopters;</li> <li>c) expansion of Appendix 2 to include helicopters and replacement of Appendix 4; and</li> <li>d) introduction of guidance on applicability.</li> </ul>	<ul style="list-style-type: none"> <li>24 March 1993</li> <li>26 July 1993</li> <li>11 November 1993</li> </ul>
5	Third Meeting of the Committee on Aviation Environmental Protection	<ul style="list-style-type: none"> <li>a) simplification and clarification of the noise certification schemes in Chapter 3 for propeller-driven aircraft;</li> <li>b) harmonization of the helicopter Standards in Chapters 8 and 11 with national codes; and</li> <li>c) alignment of the take-off mass in Chapter 10 with airworthiness limits.</li> </ul>	<ul style="list-style-type: none"> <li>19 March 1997</li> <li>21 July 1997</li> <li>6 November 1997</li> </ul>
6	Fourth Meeting of the Committee on Aviation Environmental Protection	<ul style="list-style-type: none"> <li>a) introduction of a new definition for human performance in Chapter 1;</li> <li>b) increase in stringency of Chapter 10 noise requirements for light single-engine propeller-driven aeroplanes;</li> <li>c) changes of a detailed technical nature that are intended to improve the consistency of Chapters 3, 8 and 11 as well as Appendices 2 and 4;</li> <li>d) new provisions concerning Human Factors in Part V; and</li> <li>e) changes that have arisen from the ongoing harmonization of the European Joint Aviation Requirements (JARs) and the United States Federal Aviation Regulations (FARs).</li> </ul>	<ul style="list-style-type: none"> <li>26 February 1999</li> <li>19 July 1999</li> <li>4 November 1999</li> </ul>
7	Fifth Meeting of the Committee on Aviation Environmental Protection; Annex 6, Amendment 26	<ul style="list-style-type: none"> <li>a) increase in stringency of the turbojet and heavy propeller-driven aeroplane noise requirements (new Chapter 4 — existing Chapter 4 becomes Chapter 12);</li> <li>b) new provision relating to the recertification of Chapter 3 aeroplanes;</li> <li>c) increase in stringency of the helicopter noise requirements of Chapters 8 and 11;</li> <li>d) change to clarify or redefine existing certification procedures, align with harmonized JAR/FAR requirements, introduce new provisions relating to digital instrumentation;</li> <li>e) introduction of guidance material on tilt-rotor aircraft noise certification; and</li> <li>f) inclusion of an English language version of the noise certification documents.</li> </ul>	<ul style="list-style-type: none"> <li>29 June 2001</li> <li>29 October 2001</li> <li>21 March 2002</li> </ul>

<i>Amendment</i>	<i>Source(s)</i>	<i>Subject(s)</i>	<i>Adopted Effective Applicable</i>
8 (4th Edition)	Sixth Meeting of the Committee on Aviation Environmental Protection	<ul style="list-style-type: none"> <li>a) ambient noise correction procedure including definitions for “background noise”, “ambient noise” and “broadband noise”;</li> <li>b) allowable wind speed limits during testing;</li> <li>c) applicability language clarification including temporary changes in type design and provisions to allow the recertification of Chapter 5 aeroplanes to Chapter 4;</li> <li>d) rotorcraft-related technical issues; and</li> <li>e) new Attachments G and H containing guidelines for the administration of noise certification documentation and guidelines for obtaining helicopter noise data for land-use planning purposes, respectively.</li> </ul>	23 February 2005 11 July 2005 24 November 2005
9 (5th Edition)	Seventh Meeting of the Committee on Aviation Environmental Protection	<ul style="list-style-type: none"> <li>a) introduction of new text to Attachment H containing guidelines for obtaining helicopter noise data for land-use planning purposes by providing the option for additional microphone positions;</li> <li>b) change to Note 2 of the definition of “derived version of a helicopter” to clarify that it applies to Chapter 11 as well as Chapter 8 helicopters;</li> <li>c) noise certification procedures for helicopters amended to ensure that the maximum operational rotor speed will be used;</li> <li>d) clarification of the definitions relating to wind speeds during tests;</li> <li>e) update of the International Electrotechnical Commission (IEC) references;</li> <li>f) clarification regarding the increment to be added to the <math>V_2</math> speed to determine the climb speed to be used during certification training;</li> <li>g) amendment of the applicability provisions to align them with similar provisions in other ICAO documents; and</li> <li>h) minor editorial changes.</li> </ul>	7 March 2008 20 July 2008 20 November 2008
10 (6th Edition)	Eighth meeting of the Committee on Aviation Environmental Protection (CAEP/8); Secretariat with the assistance of the Aerodrome Meteorological Observation and Forecast Study Group (AMOFSG)	<ul style="list-style-type: none"> <li>a) amendments to applicability provisions in order to remove unnecessary complexity, repetition and redundancy in the text while improving clarity and harmonization amongst different chapters;</li> <li>b) an update to the references to the <i>Environmental Technical Manual</i> (Doc 9501), Volume I — <i>Procedures for the Noise Certification of Aircraft</i>;</li> <li>c) new text in Chapter 3 to clarify noise certification take-off reference speed for cases where airworthiness certification take-off speed is not specified;</li> <li>d) improved readability and clarification of previously vague or incomplete guidance including the calculation of effective perceived noise level (EPNL), the adjustment of aircraft noise data to reference conditions using the simplified and integrated methods, measurement and characterization of atmospheric sound attenuation, and miscellaneous technical issues and editorial errors;</li> </ul>	4 March 2011 18 July 2011 17 November 2011

<i>Amendment</i>	<i>Source(s)</i>	<i>Subject(s)</i>	<i>Adopted Effective Applicable</i>
		<ul style="list-style-type: none"> <li>e) harmonization of language for noise certification procedures of tilt-rotors with that of helicopters already adopted in Chapters 8 and 11 of Annex 16, Volume I, in order to clarify that the maximum rotor revolutions per minute (RPM) corresponding with the reference flight condition shall be used;</li> <li>f) clarification that the maximum noise levels applicable to subsonic jet aeroplanes may be used as a guideline for supersonic aeroplanes;</li> <li>g) consequential amendment arising from Amendment 17 to Annex 5 replacing “km/h” by “m/s” as the SI unit to measure wind speed; and</li> <li>h) minor editorial changes.</li> </ul>	
11-A	Twelfth meeting of the Operations Panel Working Group of the Whole (OPSP/WG/WHL/12)	Amendment concerning the development of aircraft operating procedures for noise abatement.	3 March 2014 14 July 2014 13 November 2014
11-B (7th Edition)	Ninth meeting of the Committee on Aviation Environmental Protection (CAEP/9)	<ul style="list-style-type: none"> <li>a) increase in stringency of the turbojet and heavy propeller-driven aeroplane noise requirements, applicable to aeroplanes for which the application for a Type Certificate was submitted on or after 31 December 2017, and on or after 31 December 2020 for aeroplanes less than 55 000 kg in mass (new Chapter 14);</li> <li>b) introduction of noise certification requirements for tilt-rotors, applicable to aircraft for which the application for a Type Certificate was submitted on or after 1 January 2018 (new Chapter 13 — existing Attachment F guidance material remains for reference purposes);</li> <li>c) harmonization of sections on noise data validity and the scheduling of sound pressure level calibrations, and with regard to updating the specifications in the light of advances in audio recording technology;</li> <li>d) correction to the wind speed values given in m/s used for the definition of the noise certification test window;</li> <li>e) upgrade of the language in the title of Attachment A, and associated consequential amendments to equations for the calculation of maximum permitted noise levels as a function of take-off mass (i.e. including maximum permitted); and</li> <li>f) minor editorial changes to nomenclature, symbols and units.</li> </ul>	3 March 2014 14 July 2014 1 January 2015
12 (8th Edition)	Tenth meeting of the Committee on Aviation Environmental Protection (CAEP/10)	<ul style="list-style-type: none"> <li>a) harmonization of language used to define the reference atmosphere;</li> <li>b) removal of references to outdated flight path measurement techniques;</li> <li>c) corrections to guidelines for noise certification of tilt-rotors; and</li> <li>d) correction of miscellaneous technical editorial issues and an amalgamation of all symbols and units into one section.</li> </ul>	3 March 2017 21 July 2017 1 January 2018

<i>Amendment</i>	<i>Source(s)</i>	<i>Subject(s)</i>	<i>Adopted Effective Applicable</i>
13	Eleventh meeting of the Committee on Aviation Environmental Protection (CAEP/11)	a) updates of the references to the International Electrotechnical Commission (IEC) Standards IEC61260 to IEC61260-1 and IEC61260-3; and b) general technical nomenclature and typographical issues, including revision of definitions that use the word “abeam”, new definition for “reference ground track”, revision of the specified tolerance for slow exponential time averaging, and proper use of modal verbs “must”, “shall” and “should”.	11 March 2020 20 July 2020 1 January 2021



# INTERNATIONAL STANDARDS AND RECOMMENDED PRACTICES

## PART I. DEFINITIONS, NOMENCLATURE: SYMBOLS AND UNITS

**Aeroplane.** A power-driven heavier-than-air aircraft, deriving its lift in flight chiefly from aerodynamic reactions on surfaces which remain fixed under given conditions of flight.

**Aircraft.** Any machine that can derive support in the atmosphere from the reactions of the air other than the reactions of the air against the earth's surface.

**Associated aircraft systems.** Those aircraft systems drawing electrical/pneumatic power from an auxiliary power unit during ground operations.

**Auxiliary power unit (APU).** A self-contained power unit on an aircraft providing electrical/pneumatic power to aircraft systems during ground operations or in flight, separate from the propulsion engine(s).

**Bypass ratio.** The ratio of the air mass flow through the bypass ducts of a gas turbine engine to the air mass flow through the combustion chambers calculated at maximum thrust when the engine is stationary in an international standard atmosphere at sea level.

**Derived version of a helicopter.** A helicopter which, from the point of view of airworthiness, is similar to the noise certificated prototype but incorporates changes in type design which may affect its noise characteristics adversely.

*Note 1.— In applying the Standards of this Annex, a helicopter that is based on an existing prototype but which is considered by the certifying authority to be a new type design for airworthiness purposes shall nevertheless be considered as a derived version if the noise source characteristics are judged by the certifying authority to be the same as the prototype.*

*Note 2.— “Adversely” refers to an increase of more than 0.30 EPNdB in any one of the noise certification levels for helicopters certificated according to Chapter 8 and 0.30 dB(A) in the certification level for helicopters certificated according to Chapter 11.*

**Derived version of an aeroplane.** An aeroplane which, from the point of view of airworthiness, is similar to the noise certificated prototype but incorporates changes in type design which may affect its noise characteristics adversely.

*Note 1.— Where the certifying authority finds that the proposed change in design, configuration, power or mass is so extensive that a substantially new investigation of compliance with the applicable airworthiness regulations is required, the aeroplane should be considered to be a new type design rather than a derived version.*

*Note 2.*— “Adversely” refers to an increase of more than 0.10 dB in any one of the noise certification levels unless the cumulative effects of changes in type design are tracked by an approved procedure in which case “adversely” refers to a cumulative increase in the noise level in any one of the noise certification levels of more than 0.30 dB or the margin of compliance, whichever is smaller.

**External equipment (helicopter).** Any instrument, mechanism, part, apparatus, appurtenance, or accessory that is attached to or extends from the helicopter exterior but is not used nor is intended to be used for operating or controlling a helicopter in flight and is not part of an airframe or engine.

**Helicopter.** A heavier-than-air aircraft supported in flight chiefly by the reactions of the air on one or more power-driven rotors on substantially vertical axes.

**Human performance.** Human capabilities and limitations which have an impact on the safety and efficiency of aeronautical operations.

**Powered-lift.** A heavier-than-air aircraft capable of vertical take-off, vertical landing, and low-speed flight, which depends principally on engine-driven lift devices or engine thrust for the lift during these flight regimes and on non-rotating aerofoil(s) for lift during horizontal flight.

**Recertification.** Certification of an aircraft with or without a revision to its certification noise levels, to a Standard different to that to which it was originally certificated.

**Self-sustaining powered sailplane.** A powered aeroplane with available engine power which allows it to maintain level flight but not to take off under its own power.

**State of Design.** The State having jurisdiction over the organization responsible for the type design.

**State of Registry.** The State on whose register the aircraft is entered.

**Subsonic aeroplane.** An aeroplane incapable of sustaining level flight at speeds exceeding flight Mach number of 1.

**Tilt-rotor.** A powered-lift capable of vertical take-off, vertical landing, and sustained low-speed flight, which depends principally on engine-driven rotors mounted on tiltable nacelles for the lift during these flight regimes and on non-rotating aerofoil(s) for lift during high-speed flight.

**Type Certificate.** A document issued by a Contracting State to define the design of an aircraft, engine or propeller type and to certify that this design meets the appropriate airworthiness requirements of that State.

*Note.*— In some Contracting States a document equivalent to a Type Certificate may be issued for an engine or propeller type.



## NOMENCLATURE: SYMBOLS AND UNITS

*Note.*— Many of the following definitions and symbols are specific to aircraft noise certification. Some of the definitions and symbols may also apply to purposes beyond aircraft noise certification.

### 1.1 Velocity

<i>Symbol</i>	<i>Unit</i>	<i>Meaning</i>
$c_R$	m/s	<i>Reference speed of sound.</i> Speed of sound at a reference temperature condition (25°C).
$c_{HR}$	m/s	<i>Reference speed of sound at the altitude of the aeroplane.</i> The reference speed of sound corresponding to the ambient temperature – assuming a lapse rate of 0.65°C per 100 m – for a standard day at the aeroplane reference height above mean sea level.
$M_{ATR}$	—	<i>Helicopter rotor reference advancing blade tip Mach number.</i> The sum of the reference rotor rotational tip speed and the reference speed of the helicopter, divided by the reference speed of sound.
$M_H$	—	<i>Propeller helical tip Mach number.</i> The square root of the sum of the square of the propeller test rotational tip speed and the square of the test airspeed of the aeroplane, divided by the test speed of sound.
$M_{HR}$	—	<i>Propeller reference helical tip Mach number.</i> The square root of the sum of the square of the propeller reference rotational tip speed and the square of the reference speed of the aeroplane, divided by the reference speed of sound.
Best R/C	m/s	<i>Best rate of climb.</i> The certificated maximum take-off rate of climb at the maximum power setting and engine speed.
$V_{AR}$	m/s	<i>Adjusted reference speed.</i> On a non-standard test day, the helicopter reference speed adjusted to achieve the same advancing tip Mach number as the reference speed at reference conditions.
$V_{CON}$	m/s	<i>Maximum airspeed in conversion mode.</i> The never-exceed airspeed of a tilt-rotor when in conversion mode.
$V_G$	m/s	<i>Ground speed.</i> The aircraft velocity relative to the ground.
$V_{GR}$	m/s	<i>Reference ground speed.</i> The aircraft true velocity relative to the ground in the direction of the ground track under reference conditions. $V_{GR}$ is the horizontal component of the reference aircraft speed $V_R$ .
$V_H$	m/s	<i>Maximum airspeed in level flight.</i> The maximum airspeed of a helicopter in level flight when operating at maximum continuous power.

<i>Symbol</i>	<i>Unit</i>	<i>Meaning</i>
$V_{MCP}$	m/s	<i>Maximum airspeed in level flight.</i> The maximum airspeed of a tilt-rotor in level flight when operating in aeroplane mode at maximum continuous power.
$V_{MO}$	m/s	<i>Maximum operating airspeed.</i> The maximum operating limit airspeed of a tilt-rotor that may not be deliberately exceeded.
$V_{NE}$	m/s	<i>Never-exceed airspeed.</i> The maximum operating limit airspeed that may not be deliberately exceeded.
$V_R$	m/s	<i>Reference speed.</i> The aircraft true velocity at reference conditions in the direction of the reference flight path.  <i>Note.— This symbol should not be confused with the symbol commonly used for aeroplane take-off rotation speed.</i>
$V_{REF}$	m/s	<i>Reference landing airspeed.</i> The speed of the aeroplane, in a specific landing configuration, at the point where it descends through the landing screen height, in the determination of the landing distance for manual landings.
$V_S$	m/s	<i>Stalling airspeed.</i> The minimum steady airspeed in the landing configuration.
$V_{tip}$	m/s	<i>Tip speed.</i> The rotational speed of a rotor or propeller tip at test conditions, excluding the aircraft velocity component.
$V_{tipR}$	m/s	<i>Reference tip speed.</i> The rotational speed of a rotor or propeller tip at reference conditions, excluding the aircraft velocity component.
$V_Y$	m/s	<i>Speed for best rate of climb.</i> The test airspeed for best take-off rate of climb.
$V_2$	m/s	<i>Take-off safety speed.</i> The minimum airspeed for a safe take-off.

## 1.2 Time

<i>Symbol</i>	<i>Unit</i>	<i>Meaning</i>
$t_0$	s	<i>Reference duration.</i> The length of time used as a reference in the integration equation for computing EPNL, where $t_0 = 10$ s.
$t_R$	s	<i>Reference reception time.</i> The reference time of reception calculated from time of reference aircraft position and distance between aircraft and microphone used in the integrated procedure.
$\Delta t$	s	<i>Time increment.</i> The equal time increment between one-third octave band spectra, where $\Delta t = 0.5$ s.
$\delta t_R$	s	<i>Reference time increment.</i> The effective duration of a time increment between reference reception times associated with PNL points used in the integrated method.

## 1.3 Indices

<i>Symbol</i>	<i>Unit</i>	<i>Meaning</i>
$i$	—	<i>Frequency band index.</i> The numerical indicator that denotes any one of the 24 one-third octave bands with nominal geometric mean frequencies from 50 to 10 000 Hz.
$k$	—	<i>Time increment index.</i> The numerical indicator that denotes any one of the 0.5 second spectra in a noise time history. For the integrated method, the adjusted time increment associated with each value of $k$ will likely vary from the original 0.5 second time increment when projected to reference conditions.
$k_F$	—	<i>First time increment identifier.</i> Index of the first 10 dB-down point in the discrete measured PNLT time history.
$k_{FR}$	—	<i>Reference first time increment identifier.</i> Index of the first 10 dB-down point in the discrete PNLT time history for the integrated method.
$k_L$	—	<i>Last time increment identifier.</i> Index of the last 10 dB-down point in the discrete measured PNLT time history.
$k_{LR}$	—	<i>Reference last time increment identifier.</i> Index of the last 10 dB-down point in the discrete PNLT time history for the integrated method.
$k_M$	—	<i>Maximum PNLTM time increment index.</i> Time increment index of PNLTM.
$t$	s	<i>Elapsed time.</i> The length of time measured from a reference zero.
$t_1$	s	<i>Time of first 10 dB-down point.</i> The time of the first 10 dB-down point in a continuous function of time. (See $k_F$ .)
$t_2$	s	<i>Time of last 10 dB-down point.</i> The time of the last 10 dB-down point in a continuous function of time. (See $k_L$ .)

## 1.4 Noise metrics

<i>Symbol</i>	<i>Unit</i>	<i>Meaning</i>
EPNL	EPNdB	<i>Effective perceived noise level.</i> A single-number evaluator for an aircraft pass-by, accounting for the subjective effects of aircraft noise on human beings, consisting of an integration over the noise duration of the perceived noise level (PNL) adjusted for spectral irregularities (PNLT), normalized to a reference duration of 10 seconds. (See Appendix 2, Section 4.1 for specifications.)
EPNL <sub>A</sub>	EPNdB	<i>Approach EPNL.</i> Effective perceived noise level at the aeroplane approach reference measurement points.
EPNL <sub>F</sub>	EPNdB	<i>Flyover EPNL.</i> Effective perceived noise level at the aeroplane flyover reference measurement points.

<i>Symbol</i>	<i>Unit</i>	<i>Meaning</i>
EPNL <sub>L</sub>	EPNdB	<i>Lateral EPNL</i> . Effective perceived noise level at the aeroplane lateral reference measurement points.
L <sub>AE</sub>	dB(A)	<i>Sound exposure level (SEL)</i> . A single event noise level for an aircraft pass-by, consisting of an integration over the noise duration of the A-weighted sound level (dB(A), normalized to a reference duration of 1 second). (See Appendix 4, Section 3 for specifications.)
L <sub>AS</sub>	dB(A)	<i>Slow A-weighted sound level</i> . Sound level with frequency weighting A and time weighting S for a specified instance in time.
L <sub>ASmax</sub>	dB(A)	<i>Maximum slow A-weighted sound level</i> . The maximum value of L <sub>AS</sub> over a specified time interval.
L <sub>ASmaxR</sub>	dB(A)	<i>Reference maximum slow A-weighted sound level</i> . The maximum value of L <sub>AS</sub> over a specified time interval corrected to reference conditions.
LIMIT <sub>A</sub>	EPNdB	<i>Approach EPNL limit</i> . The maximum permitted noise level at the aeroplane approach reference measurement points.
LIMIT <sub>F</sub>	EPNdB	<i>Flyover EPNL limit</i> . The maximum permitted noise level at the aeroplane flyover reference measurement points.
LIMIT <sub>L</sub>	EPNdB	<i>Lateral EPNL limit</i> . The maximum permitted noise level at the aeroplane lateral reference measurement points.
<i>n</i>	noy	<i>Perceived noisiness</i> . The perceived noisiness of a one-third octave band sound pressure level in a given spectrum.
<i>N</i>	noy	<i>Total perceived noisiness</i> . The total perceived noisiness of a given spectrum calculated from the 24 values of <i>n</i> .
PNL	PNdB	<i>Perceived noise level</i> . A perception-based noise evaluator representing the subjective effects of broadband noise received at a given point in time during an aircraft pass-by. It is the noise level empirically determined to be equally as noisy as a 1 kHz one-third octave band sample of random noise. (See Appendix 2, Section 4.2 for specifications.)
PNLT	TPNdB	<i>Tone-corrected perceived noise level</i> . The value of the PNL of a given spectrum adjusted for spectral irregularities.
PNLT <sub>R</sub>	TPNdB	<i>Reference tone-corrected perceived noise level</i> . The value of PNLT adjusted to reference conditions.
PNLTM	TPNdB	<i>Maximum tone-corrected perceived noise level</i> . The maximum value of PNLT in a specified time history, adjusted for the bandsharing adjustment $\Delta_B$ .
PNLTM <sub>R</sub>	TPNdB	<i>Reference maximum tone-corrected perceived noise level</i> . The maximum value of PNLT <sub>R</sub> in a specified time history, adjusted for the bandsharing adjustment $\Delta_B$ in the simplified method and $\Delta_{BR}$ in the integrated method.

Symbol	Unit	Meaning
SPL	dB	<i>Sound pressure level.</i> The level of sound, relative to the reference level of 20 $\mu\text{Pa}$ , at any instant of time that occurs in a specified frequency range. The level is calculated as ten times the logarithm to the base 10 of the ratio of the time-mean-square pressure of the sound to the square of the reference sound pressure of 20 $\mu\text{Pa}$ .  <i>Note.</i> — Typical aircraft noise certification usage refers to a specific one-third octave band, e.g. $\text{SPL}(i,k)$ for the $i$ -th band of the $k$ -th spectrum in an aircraft noise time-history.
$\text{SPL}_R$	dB	<i>Reference sound pressure level.</i> The one-third octave band sound pressure levels adjusted to reference conditions.
$\text{SPL}_S$	dB	<i>Slow weighted sound pressure level.</i> The value of one-third octave band sound pressure levels with time weighting S applied.
$\Delta_1$	TPNdB	<i>PNLTM adjustment.</i> Under Appendix 2 or Attachment F. In the simplified adjustment method, the adjustment to be added to the measured EPNL to account for noise level changes due to differences in atmospheric absorption and noise path length, between test and reference conditions at PNLTM.
	dB(A)	Under Appendix 4. The adjustments to be added to the measured $L_{AE}$ to account for noise level changes for spherical spreading and duration due to the difference between test and reference helicopter height.
	dB(A)	Under Appendix 6. For propeller-driven aeroplanes not exceeding 8 618 kg, the adjustment to be added to the measured $L_{ASmax}$ to account for noise level changes due to the difference between test and reference aeroplane heights.
$\Delta_2$	TPNdB	<i>Duration adjustment.</i> Under Appendix 2 or Attachment F. In the simplified adjustment method, the adjustment to be added to the measured EPNL to account for noise level changes due to the change in noise duration, caused by differences between test and reference aircraft speed and position relative to the microphone.
	dB(A)	Under Appendix 4. The adjustments to be added to the measured $L_{AE}$ to account for noise level changes due to the difference between reference and adjusted airspeed.
	dB(A)	Under Appendix 6. For propeller-driven aeroplanes not exceeding 8 618 kg, the adjustment to be added to the measured $L_{ASmax}$ to account for the noise level changes due to the difference between test and reference propeller helical tip Mach number.

<i>Symbol</i>	<i>Unit</i>	<i>Meaning</i>
$\Delta_3$	TPNdB	<i>Source noise adjustment.</i> Under Appendix 2. In the simplified or integrated adjustment method, the adjustment to be added to the measured EPNL to account for noise level changes due to differences in source noise generating mechanisms, between test and reference conditions.
	dB(A)	Under Appendix 6. For propeller-driven aeroplanes not exceeding 8 618 kg, the adjustment to be added to the measured $L_{ASmax}$ to account for noise level changes due to the difference between test and reference engine power.
$\Delta_4$	dB(A)	<i>Atmospheric absorption adjustment.</i> Under Appendix 6. For propeller-driven aeroplanes not exceeding 8 618 kg, the adjustment to be added to the measured $L_{ASmax}$ for noise level changes due to the change in atmospheric absorption, caused by the difference between test and reference aeroplane heights.
	TPNdB	<i>Bandsharing adjustment.</i> The adjustment to be added to the maximum PNLT to account for possible suppression of a tone due to one-third octave bandsharing of that tone. PNLT <sub>M</sub> is equal to the maximum PNLT plus $\Delta_B$ .
$\Delta_{BR}$	TPNdB	<i>Reference bandsharing adjustment.</i> The adjustment to be added to the maximum PNLT <sub>R</sub> in the integrated method to account for possible suppression of a tone due to one-third octave bandsharing of that tone. PNLT <sub>M</sub> is equal to the maximum PNLT <sub>R</sub> plus $\Delta_{BR}$ .
$\Delta_{peak}$	TPNdB	<i>Peak adjustment.</i> The adjustment to be added to the measured EPNL for when the PNLT for a secondary peak, identified in the calculation of EPNL from measured data and adjusted to reference conditions, is greater than the PNLT for the adjusted PNLT <sub>M</sub> spectrum.

### 1.5 Calculation of PNL and tone correction

<i>Symbol</i>	<i>Unit</i>	<i>Meaning</i>
$C$	dB	<i>Tone correction factor.</i> The factor to be added to the PNL of a given spectrum to account for the presence of spectral irregularities, such as tones.
$f$	Hz	<i>Frequency.</i> The nominal geometric mean frequency of a one-third octave band.
$F$	dB	<i>Delta-dB.</i> The difference between the original sound pressure level and the final broadband sound pressure level of a one-third octave band in a given spectrum.
$\log n(a)$	—	<i>Noy discontinuity coordinate.</i> The $\log n$ value of the intersection point of the straight lines representing the variation of SPL with $\log n$ .
$M$	—	<i>Noy inverse slope.</i> The reciprocals of the slopes of straight lines representing the variation of SPL with $\log n$ .

<i>Symbol</i>	<i>Unit</i>	<i>Meaning</i>
$s$	dB	<i>Slope of sound pressure level.</i> The change in level between adjacent one-third octave band sound pressure levels in a given spectrum.
$\Delta s$	dB	<i>Change in slope of sound pressure level.</i>
$s'$	dB	<i>Adjusted slope of sound pressure level.</i> The change in level between adjacent adjusted one-third octave band sound pressure levels in a given spectrum.
$\bar{s}$	dB	<i>Average slope of sound pressure level.</i>
SPL( <i>a</i> )	dB	<i>Noy discontinuity level.</i> The SPL value at the discontinuity coordinate of the straight lines representing the variation of SPL with $\log n$ .
SPL( <i>b</i> ) SPL( <i>c</i> )	dB	<i>Noy intercept levels.</i> The intercepts on the SPL-axis of the straight lines representing the variation of SPL with $\log n$ .
SPL( <i>d</i> )	dB	<i>Noy discontinuity level.</i> The SPL value at the discontinuity coordinate where $\log n$ equals $-1$ .
SPL( <i>e</i> )	dB	<i>Noy discontinuity level.</i> The SPL value at the discontinuity coordinate where $\log n$ equals $\log 0.3$ .
SPL'	dB	<i>Adjusted sound pressure level.</i> The first approximation to broadband sound pressure level in a one-third octave band of a given spectrum.
SPL''	dB	<i>Final broadband sound pressure level.</i> The second and final approximation to broadband sound pressure level in a one-third octave band of a given spectrum.

### 1.6 Flight path geometry

<i>Symbol</i>	<i>Unit</i>	<i>Meaning</i>
H	m	<i>Height.</i> The aircraft height at the point where the flight path intercepts the vertical geometrical plane perpendicular to the reference ground track at the centre microphone.
H <sub>R</sub>	m	<i>Reference height.</i> The reference aircraft height at the point where the reference flight path intercepts the vertical geometrical plane perpendicular to the reference ground track at the centre microphone.
X	m	<i>Aircraft position along the ground track.</i> The position coordinate of the aircraft along the x-axis at a specific point in time.
Y	m	<i>Lateral aircraft position relative to the reference ground track.</i> The position coordinate of the aircraft along the y-axis at a specific point in time.
Z	m	<i>Vertical aircraft position relative to the reference ground track.</i> The position coordinate of the aircraft along the z-axis at a specific point in time.

<i>Symbol</i>	<i>Unit</i>	<i>Meaning</i>
$\theta$	degrees	<i>Sound emission angle.</i> The angle between the flight path and the direct sound propagation path to the microphone. The angle is identical for both the measured and reference flight paths.
$\psi$	degrees	<i>Elevation angle.</i> The angle between the sound propagation path and a horizontal plane passing through the microphone, where the sound propagation path is defined as a line between a sound emission point on the measured flight path and the microphone diaphragm.
$\psi_R$	degrees	<i>Reference elevation angle.</i> The angle between the reference sound propagation path and a horizontal plane passing through the reference microphone location, where the reference sound propagation path is defined as a line between a sound emission point on the reference flight path and the reference microphone diaphragm.

### 1.7 Miscellaneous

<i>Symbol</i>	<i>Unit</i>	<i>Meaning</i>
antilog	—	<i>Antilogarithm to the base 10.</i>
D	m	<i>Diameter.</i> Propeller or rotor diameter.
D <sub>15</sub>	m	<i>Take-off distance.</i> The take-off distance required for an aeroplane to reach 15 m height above ground level.
<i>e</i>	—	<i>Euler's number.</i> The mathematical constant that is the base number of the natural logarithm, approximately 2.71828.
log	—	<i>Logarithm to the base 10.</i>
N	rpm	<i>Propeller speed.</i>
N <sub>1</sub>	rpm	<i>Compressor speed.</i> The turbine engine low pressure compressor first stage fan speed.
RH	%	<i>Relative humidity.</i> The ambient atmospheric relative humidity.
T	°C	<i>Temperature.</i> The ambient atmospheric temperature.
u	m/s	<i>Wind speed along-track component.</i> The component of the wind speed vector along the reference ground track.
v	m/s	<i>Wind speed cross-track component.</i> The component of the wind speed vector horizontally perpendicular to the reference ground track.



---

<i>Symbol</i>	<i>Unit</i>	<i>Meaning</i>
$\alpha$	dB/100 m	<i>Test atmospheric absorption coefficient.</i> The sound attenuation rate, due to atmospheric absorption, that occurs in a specified one-third octave band for the measured ambient temperature and relative humidity.
$\alpha_R$	dB/100 m	<i>Reference atmospheric absorption coefficient.</i> The sound attenuation rate, due to atmospheric absorption, that occurs in a specified one-third octave band for a reference ambient temperature and relative humidity.
$\mu$	—	<i>Engine noise performance parameter.</i> For jet aeroplanes, typically the normalized low pressure fan speed, normalized engine thrust, or engine pressure ratio used in the calculation of the source noise adjustment.

---



## PART II. AIRCRAFT NOISE CERTIFICATION

### CHAPTER 1. ADMINISTRATION

1.1 The provisions of 1.2 to 1.6 shall apply to all aircraft included in the classifications defined for noise certification purposes in Chapters 2, 3, 4, 5, 6, 8, 10, 11, 12, 13 and 14 of this part where such aircraft are engaged in international air navigation.

1.2 Noise certification shall be granted or validated by the State of Registry of an aircraft on the basis of satisfactory evidence that the aircraft complies with requirements that are at least equal to the applicable Standards specified in this Annex.

1.3 If noise recertification is requested, it shall be granted or validated by the State of Registry of an aircraft on the basis of satisfactory evidence that the aircraft complies with requirements that are at least equal to the applicable Standards specified in this Annex. The date used by a certifying authority to determine the recertification basis shall be the date of acceptance of the first application for recertification.

1.4 The documents attesting noise certification shall be approved by the State of Registry and shall be required by that State to be carried on the aircraft.

*Note.— See Annex 6, Part I, 6.13, concerning the translation into English of documents attesting noise certification.*

1.5 The documents attesting noise certification for an aircraft shall provide at least the following information:

- Item 1. Name of State.
- Item 2. Title of the noise document.
- Item 3. Number of the document.
- Item 4. Nationality or common mark and registration marks.
- Item 5. Manufacturer and manufacturer's designation of aircraft.
- Item 6. Aircraft serial number.
- Item 7. Engine manufacturer, type and model.
- Item 8. Propeller type and model for propeller-driven aeroplanes.
- Item 9. Maximum take-off mass in kilograms.
- Item 10. Maximum landing mass, in kilograms, for certificates issued under Chapters 2, 3, 4, 5, 12 and 14 of this Annex.

- Item 11. The chapter and section of this Annex according to which the aircraft was certificated.
- Item 12. Additional modifications incorporated for the purpose of compliance with the applicable noise certification Standards.
- Item 13. The lateral/full-power noise level in the corresponding unit for documents issued under Chapters 2, 3, 4, 5, 12 and 14 of this Annex.
- Item 14. The approach noise level in the corresponding unit for documents issued under Chapters 2, 3, 4, 5, 8, 12, 13 and 14 of this Annex.
- Item 15. The flyover noise level in the corresponding unit for documents issued under Chapters 2, 3, 4, 5, 12 and 14 of this Annex.
- Item 16. The overflight noise level in the corresponding unit for documents issued under Chapters 6, 8, 11 and 13 of this Annex.
- Item 17. The take-off noise level in the corresponding unit for documents issued under Chapters 8, 10 and 13 of this Annex.
- Item 18. Statement of compliance, including a reference to Annex 16, Volume I.
- Item 19. Date of issuance of the noise certification document.
- Item 20. Signature of the officer issuing it.

1.6 Item headings on the noise certification documents shall be uniformly numbered in Arabic numerals, as indicated in 1.5, so that on any noise certification document the number will, under any arrangement, refer to the same item heading, except where the information in Items 1 through 6 and Items 18 through 20 is given in the certificate of airworthiness, in which case the numbering system of the certificate of airworthiness according to Annex 8 shall prevail.

1.7 An administrative system for implementation of noise certification documentation shall be developed by the State of Registry.

*Note.— See Attachment G for guidance on the format and structure of noise certification documentation.*

1.8 Contracting States shall recognize as valid a noise certification granted by another Contracting State provided that the requirements under which such certification was granted are at least equal to the applicable Standards specified in this Annex.

1.9 A Contracting State shall suspend or revoke the noise certification of an aircraft on its register if the aircraft ceases to comply with the applicable noise Standards. The State of Registry shall not remove the suspension of a noise certification or grant a new noise certification unless the aircraft is found, on reassessment, to comply with the applicable noise Standards.

1.10 The amendment of this volume of the Annex to be used by a Contracting State shall be that which is applicable on the date of submission to that Contracting State for:

- a) a Type Certificate in the case of a new type; or
- b) approval of a change in type design in the case of a derived version; or
- c) in either case, under an equivalent application procedure prescribed by the certifying authority of that Contracting State.

*Note.*— As each new edition and amendment of this Annex becomes applicable (according to Table A of the Foreword) it supersedes all previous editions and amendments.

1.11 Unless otherwise specified in this volume of the Annex, the date to be used by Contracting States in determining the applicability of the Standards in this Annex shall be the date the application for a Type Certificate was submitted to the State of Design, or the date of submission under an equivalent application procedure prescribed by the certifying authority of the State of Design.

1.12 For derived versions where the provisions governing the applicability of the Standards of this Annex refer to “the application for the certification of the change in type design”, the date to be used by Contracting States in determining the applicability of the Standards in this Annex shall be the date the application for the change in type design was submitted to the Contracting State that first certified the change in type design, or the date of submission under an equivalent application procedure prescribed by the certifying authority of the Contracting State that first certified the change in type design.

*Note 1.*— Unless otherwise specified in this volume of the Annex, the edition of the Environmental Technical Manual (Doc 9501), Volume I — Procedures for the Noise Certification of Aircraft, to be used as guidance on the use of acceptable means of compliance and equivalent procedures by a Contracting State should be that which is in effect on the date the application for a Type Certificate or the change in type design is submitted to that Contracting State.

*Note 2.*— The means of compliance and the use of equivalent procedures are subject to the acceptance of the certifying authority of the Contracting State.

1.13 An application shall be effective for the period specified in the designation of the airworthiness regulations appropriate to the aircraft type, except in special cases where the certifying authority accepts an extension of this period. When this period of effectivity is exceeded, the date to be used in determining the applicability of the Standards in this Annex shall be the date of issue of the Type Certificate or approval of the change in type design, or the date of issue of approval under an equivalent procedure prescribed by the State of Design, less the period of effectivity.



## CHAPTER 2. SUBSONIC JET AEROPLANES — Application for Type Certificate submitted before 6 October 1977

### 2.1 Applicability

*Note.*— See also Chapter 1, 1.10, 1.11, 1.12 and 1.13.

2.1.1 The Standards of this chapter shall be applicable to all subsonic jet aeroplanes for which the application for a Type Certificate was submitted before 6 October 1977, except those aeroplanes:

- a) requiring a runway length<sup>1</sup> of 610 m or less at maximum certificated mass for airworthiness; or
- b) powered by engines with a bypass ratio of 2 or more and for which a certificate of airworthiness for the individual aeroplane was first issued before 1 March 1972; or
- c) powered by engines with a bypass ratio of less than 2 and for which the application for a Type Certificate was submitted before 1 January 1969, and for which a certificate of airworthiness for the individual aeroplane was first issued before 1 January 1976.

2.1.2 The maximum noise levels of 2.4.1 shall apply except for derived versions for which the application for certification of the change in type design was submitted on or after 26 November 1981, in which case the maximum noise levels of 2.4.2 shall apply.

2.1.3 Notwithstanding 2.1.1 and 2.1.2, it may be recognized by a Contracting State that the following situations for jet aeroplanes, and propeller-driven aeroplanes over 8 618 kg maximum certificated take-off mass on its registry do not require demonstration of compliance with the provisions of the Standards of Annex 16, Volume I:

- a) gear down flight with one or more retractable landing gear down during the entire flight;
- b) spare engine and nacelle carriage external to the skin of the aeroplane (and return of the pylon or other external mount); and
- c) time-limited engine and/or nacelle changes, where the change in type design specifies that the aeroplane may not be operated for a period of more than 90 days unless compliance with the provisions of Annex 16, Volume I, is shown for that change in type design. This applies only to changes resulting from a required maintenance action.

### 2.2 Noise evaluation measure

The noise evaluation measure shall be the effective perceived noise level in EPNdB as described in Appendix 1.

---

1. With no stopway or clearway.

### 2.3 Noise measurement points

An aeroplane, when tested in accordance with the flight test procedures of 2.6, shall not exceed the noise levels specified in 2.4 at the following points:

- a) *lateral noise measurement point*: the point on a line parallel to and 650 m from the runway centre line, or extended runway centre line, where the noise level is a maximum during take-off;
- b) *flyover noise measurement point*: the point on the extended centre line of the runway and at a distance of 6.5 km from the start of roll; and
- c) *approach noise measurement point*: the point on the ground, on the extended centre line of the runway, 120 m (394 ft) vertically below the 3° descent path originating from a point 300 m beyond the threshold. On level ground this corresponds to a position 2 000 m from the threshold.

### 2.4 Maximum noise levels

2.4.1 The maximum noise levels of those aeroplanes covered by 2.1.1, when determined in accordance with the noise evaluation method of Appendix 1, shall not exceed the following:

- a) *at lateral and approach noise measurement points*: 108 EPNdB for aeroplanes with maximum certificated take-off mass of 272 000 kg or over, decreasing linearly with the logarithm of the mass at the rate of 2 EPNdB per halving of the mass down to 102 EPNdB at 34 000 kg, after which the limit remains constant;
- b) *at flyover noise measurement point*: 108 EPNdB for aeroplanes with maximum certificated take-off mass of 272 000 kg or over, decreasing linearly with the logarithm of the mass at the rate of 5 EPNdB per halving of the mass down to 93 EPNdB at 34 000 kg, after which the limit remains constant.

*Note.*— See Attachment A for equations for the calculation of maximum permitted noise levels as a function of take-off mass.

2.4.2 The maximum noise levels of those aeroplanes covered by 2.1.2, when determined in accordance with the noise evaluation method of Appendix 1, shall not exceed the following:

#### 2.4.2.1 *At lateral noise measurement point*

106 EPNdB for aeroplanes with maximum certificated take-off mass of 400 000 kg or over, decreasing linearly with the logarithm of the mass down to 97 EPNdB at 35 000 kg, after which the limit remains constant.

#### 2.4.2.2 *At flyover noise measurement point*

- a) *Aeroplanes with two engines or less*

104 EPNdB for aeroplanes with maximum certificated take-off mass of 325 000 kg or over, decreasing linearly with the logarithm of the mass at the rate of 4 EPNdB per halving of mass down to 93 EPNdB, after which the limit remains constant.



b) *Aeroplanes with three engines*

As a) but with 107 EPNdB for aeroplanes with maximum certificated take-off mass of 325 000 kg or over

*or*

as defined by 2.4.1 b), whichever is the lower.

c) *Aeroplanes with four engines or more*

As a) but with 108 EPNdB for aeroplanes with maximum certificated take-off mass of 325 000 kg or over

*or*

as defined by 2.4.1 b), whichever is the lower.

2.4.2.3 *At approach noise measurement point*

108 EPNdB for aeroplanes with maximum certificated take-off mass of 280 000 kg or over, decreasing linearly with the logarithm of the mass down to 101 EPNdB at 35 000 kg, after which the limit remains constant.

*Note.*— See Attachment A for equations for the calculation of maximum permitted noise levels as a function of take-off mass.

## 2.5 Trade-offs

If the maximum noise levels are exceeded at one or two measurement points:

- a) the sum of excesses shall not be greater than 4 EPNdB, except that in respect of four-engined aeroplanes powered by engines with a bypass ratio of 2 or more and for which the application for a certificate of airworthiness for the prototype was accepted, or another equivalent prescribed procedure was carried out by the certifying authority, before 1 December 1969, the sum of any excesses shall not be greater than 5 EPNdB;
- b) any excess at any single point shall not be greater than 3 EPNdB; and
- c) any excesses shall be offset by corresponding reductions at the other point or points.

## 2.6 Test procedures

### 2.6.1 Take-off test procedure

2.6.1.1 Average take-off thrust<sup>2</sup> shall be used from the start of take-off to the point at which a height of at least 210 m (690 ft) above the runway is reached, and the thrust thereafter shall not be reduced below that thrust which will maintain a climb gradient of at least 4 per cent.

---

2. Take-off thrust representative of the mean characteristics of the production engine.

2.6.1.2 A speed of at least  $V_2 + 19$  km/h ( $V_2 + 10$  kt) shall be attained as soon as practicable after lift-off and be maintained throughout the take-off noise certification test.

2.6.1.3 A constant take-off configuration selected by the applicant shall be maintained throughout the take-off noise certification demonstration test except that the landing gear may be retracted.

## 2.6.2 Approach test procedure

2.6.2.1 The aeroplane shall be stabilized and following a  $3^\circ \pm 0.5^\circ$  glide path.

2.6.2.2 The approach shall be made at a stabilized airspeed of not less than  $1.3 V_S + 19$  km/h ( $1.3 V_S + 10$  kt) with thrust stabilized during approach and over the measuring point and continued to a normal touchdown.

2.6.2.3 The configuration of the aeroplane shall be with maximum allowable landing flap setting.

*Note.*— *Guidance material on the use of equivalent procedures is provided in the Environmental Technical Manual (Doc 9501), Volume I — Procedures for the Noise Certification of Aircraft.*

## CHAPTER 3.

- 1.— **SUBSONIC JET AEROPLANES — Application for Type Certificate submitted on or after 6 October 1977 and before 1 January 2006**
- 2.— **PROPELLER-DRIVEN AEROPLANES OVER 8 618 kg — Application for Type Certificate submitted on or after 1 January 1985 and before 1 January 2006**

### 3.1 Applicability

*Note 1.— See also Chapter 1, 1.10, 1.11, 1.12 and 1.13.*

*Note 2.— See Attachment E for guidance on interpretation of these applicability provisions.*

3.1.1 The Standards of this chapter shall, with the exception of those propeller-driven aeroplanes specifically designed and used for agricultural or firefighting purposes, be applicable to:

- a) all subsonic jet aeroplanes, including their derived versions, other than aeroplanes which require a runway<sup>1</sup> length of 610 m or less at maximum certificated mass for airworthiness, for which the application for a Type Certificate was submitted on or after 6 October 1977 and before 1 January 2006; and
- b) all propeller-driven aeroplanes, including their derived versions, of over 8 618 kg maximum certificated take-off mass, for which the application for a Type Certificate was submitted on or after 1 January 1985 and before 1 January 2006.

3.1.2 Notwithstanding 3.1.1, it may be recognized by a Contracting State that the following situations for jet aeroplanes, and propeller-driven aeroplanes over 8 618 kg maximum certificated take-off mass on its registry do not require demonstration of compliance with the provisions of the Standards of Annex 16, Volume I:

- a) gear down flight with one or more retractable landing gear down during the entire flight;
- b) spare engine and nacelle carriage external to the skin of the aeroplane (and return of the pylon or other external mount); and
- c) time-limited engine and/or nacelle changes, where the change in type design specifies that the aeroplane may not be operated for a period of more than 90 days unless compliance with the provisions of Annex 16, Volume I, is shown for that change in type design. This applies only to changes resulting from a required maintenance action.

### 3.2 Noise measurements

#### 3.2.1 Noise evaluation measure

The noise evaluation measure shall be the effective perceived noise level in EPNdB as described in Appendix 2.

---

1. With no stopway or clearway.

### 3.3 Noise measurement points

#### 3.3.1 Reference noise measurement points

An aeroplane, when tested in accordance with these Standards, shall not exceed the noise levels specified in 3.4 at the following points:

- a) *lateral full-power reference noise measurement point*
  - 1) for jet-powered aeroplanes: the point on a line parallel to and 450 m from the runway centre line, where the noise level is a maximum during take-off;
  - 2) for propeller-driven aeroplanes: the point on the extended centre line of the runway 650 m vertically below the climb-out flight path at full take-off power, as defined in 3.6.2. Until 19 March 2002, the requirement for lateral noise in 3.3.1 a) 1) shall alternatively be permitted;

*Note.— For aeroplanes specified in 3.1.1 b) for which the application for a Type Certificate was submitted before 19 March 2002, the lateral noise requirement specified in 3.3.1 a) 1) is permitted as an alternative.*
- b) *flyover reference noise measurement point*: the point on the extended centre line of the runway and at a distance of 6.5 km from the start of roll;
- c) *approach reference noise measurement point*: the point on the ground, on the extended centre line of the runway, 2 000 m from the threshold. On level ground this corresponds to a position 120 m (394 ft) vertically below the 3° descent path originating from a point 300 m beyond the threshold.

#### 3.3.2 Test noise measurement points

3.3.2.1 If the test noise measurement points are not located at the reference noise measurement points, any corrections for the difference in position shall be made in the same manner as the corrections for the differences between test and reference flight paths.

3.3.2.2 Sufficient lateral test noise measurement points shall be used to demonstrate to the certifying authority that the maximum noise level on the appropriate lateral line has been clearly determined. For jet-powered aeroplanes simultaneous measurements shall be made at one test noise measurement point at a symmetrical position on the other side of the runway. In the case of propeller-driven aeroplanes, because of their inherent asymmetry in lateral noise, simultaneous measurements shall be made at each and every test noise measurement point at a symmetrical position (within  $\pm 10$  m parallel with the axis of the runway) on the opposite side of the runway.

### 3.4 Maximum noise levels

3.4.1 The maximum noise levels, when determined in accordance with the noise evaluation method of Appendix 2, shall not exceed the following:

#### 3.4.1.1 *At the lateral full-power reference noise measurement point*

103 EPNdB for aeroplanes with maximum certificated take-off mass, at which the noise certification is requested, of 400 000 kg and over and decreasing linearly with the logarithm of the mass down to 94 EPNdB at 35 000 kg, after which the limit remains constant.

#### 3.4.1.2 At flyover reference noise measurement point

a) *Aeroplanes with two engines or less*

101 EPNdB for aeroplanes with maximum certificated take-off mass, at which the noise certification is requested, of 385 000 kg and over and decreasing linearly with the logarithm of the aeroplane mass at the rate of 4 EPNdB per halving of mass down to 89 EPNdB, after which the limit is constant.

b) *Aeroplanes with three engines*

As a) but with 104 EPNdB for aeroplanes with maximum certificated take-off mass of 385 000 kg and over.

c) *Aeroplanes with four engines or more*

As a) but with 106 EPNdB for aeroplanes with maximum certificated take-off mass of 385 000 kg and over.

#### 3.4.1.3 At approach reference noise measurement point

105 EPNdB for aeroplanes with maximum certificated take-off mass, at which the noise certification is requested, of 280 000 kg or over, and decreasing linearly with the logarithm of the mass down to 98 EPNdB at 35 000 kg, after which the limit remains constant.

*Note.*— See Attachment A for equations for the calculation of maximum permitted noise levels as a function of take-off mass.

### 3.5 Trade-offs

If the maximum noise levels are exceeded at one or two measurement points:

- a) the sum of excesses shall not be greater than 3 EPNdB;
- b) any excess at any single point shall not be greater than 2 EPNdB; and
- c) any excesses shall be offset by corresponding reductions at the other point or points.

### 3.6 Noise certification reference procedures

#### 3.6.1 General conditions

3.6.1.1 The reference procedures shall comply with the appropriate airworthiness requirements.

3.6.1.2 The calculations of reference procedures and flight paths shall be approved by the certifying authority.

3.6.1.3 Except in conditions specified in 3.6.1.4, the take-off and approach reference procedures shall be those defined in 3.6.2 and 3.6.3, respectively.

3.6.1.4 When it is shown by the applicant that the design characteristics of the aeroplane would prevent flight being conducted in accordance with 3.6.2 and 3.6.3, the reference procedures shall:

- a) depart from the reference procedures defined in 3.6.2 and 3.6.3 only to the extent demanded by those design characteristics which make compliance with the procedures impossible; and
- b) be approved by the certifying authority.

3.6.1.5 The reference procedures shall be calculated under the following reference atmospheric conditions:

- a) atmospheric pressure at sea level of 1 013.25 hPa, decreasing with altitude at a rate defined by the ICAO Standard Atmosphere;
- b) ambient air temperature at sea level of 25°C, decreasing with altitude at a rate defined by the ICAO Standard Atmosphere (i.e. 0.65°C per 100 m);
- c) constant relative humidity of 70 per cent;
- d) zero wind;
- e) for the purpose of defining the reference take-off profiles for both take-off and lateral noise measurements, the runway gradient is zero; and
- f) the reference atmosphere in terms of temperature and relative humidity is considered to be homogeneous (i.e. ambient temperature 25°C and relative humidity 70 per cent) for the purpose of calculating:
  - 1) the reference sound attenuation rate due to atmospheric absorption; and
  - 2) the reference speed of sound used in the calculation of the reference sound propagation geometry.

*Note 1.— Details for calculating the variation of reference atmospheric pressure with altitude are given in the section of the Environmental Technical Manual (Doc 9501), Volume I — Procedures for the Noise Certification of Aircraft, concerning the ICAO Standard Atmosphere.*

*Note 2.— The characteristics of the ICAO Standard Atmosphere are provided in the Manual of the ICAO Standard Atmosphere (extended to 80 kilometres (262 500 feet) (Doc 7488/3).*

### 3.6.2 Take-off reference procedure

Take-off reference flight path shall be calculated as follows:

- a) average engine take-off thrust or power shall be used from the start of take-off to the point where at least the following height above runway level is reached:
  - 1) aeroplanes with two engines or less — 300 m (984 ft);
  - 2) aeroplanes with three engines — 260 m (853 ft);
  - 3) aeroplanes with four engines or more — 210 m (689 ft);

- b) upon reaching the height specified in a) above, the thrust or power shall not be reduced below that required to maintain:
- 1) a climb gradient of 4 per cent; or
  - 2) in the case of multi-engined aeroplanes, level flight with one engine inoperative;
- whichever thrust or power is greater;
- c) for the purpose of determining the lateral full-power noise level, the reference flight path shall be calculated on the basis of using full take-off power throughout without a thrust or power reduction;
- d) the speed shall be:
- 1) for those aeroplanes for which the applicable airworthiness requirements define  $V_2$ , the all-engines operating take-off climb speed selected by the applicant for use in normal operation, which shall be at least  $V_2 + 19$  km/h ( $V_2 + 10$  kt) but not greater than  $V_2 + 37$  km/h ( $V_2 + 20$  kt) and which shall be attained as soon as practicable after lift-off and be maintained throughout the take-off noise certification test. The increment applied to  $V_2$  shall be the same for all reference masses of an aeroplane model unless a difference in increment is substantiated based on performance characteristics of the aeroplane.

*Note.*—  $V_2$  is defined in accordance with the applicable airworthiness requirements.

- 2) for those aeroplanes for which the applicable airworthiness requirements do not define  $V_2$ , the take-off speed at 15 m (50 ft) plus an increment of at least 19 km/h (10 kt) but not greater than 37 km/h (20 kt), or the minimum climb speed, whichever speed is greater. This speed shall be attained as soon as practicable after lift-off and be maintained throughout the take-off noise certification test.

*Note.*— Take-off speed at 15 m (50 ft) and minimum climb speed are defined in accordance with the applicable airworthiness requirements.

- e) a constant take-off configuration selected by the applicant shall be maintained throughout the take-off reference procedure except that the landing gear may be retracted. Configuration shall be interpreted as meaning the conditions of the systems and centre of gravity position and shall include the position of lift augmentation devices used, whether the APU is operating, and whether air bleeds and power off-takes are operating;
- f) the mass of the aeroplane at the brake release shall be the maximum take-off mass at which the noise certification is requested; and
- g) the average engine shall be defined by the average of all the certification compliant engines used during the aeroplane flight tests up to and during certification when operated to the limitations and procedures given in the flight manual. This will establish a technical standard including the relationship of thrust/power to control parameters (e.g.  $N_1$  or EPR). Noise measurements made during certification tests shall be corrected to this standard.

*Note.*— Take-off thrust/power used shall be the maximum available for normal operations as scheduled in the performance section of the aeroplane flight manual for the reference atmospheric conditions given in 3.6.1.5.

### 3.6.3 Approach reference procedure

The approach reference flight path shall be calculated as follows:

- a) the aeroplane shall be stabilized and following a  $3^\circ$  glide path;

- b) a steady approach speed of  $V_{REF} + 19$  km/h ( $V_{REF} + 10$  kt), with thrust or power stabilized, shall be maintained over the measurement point;

*Note.— In airworthiness terms  $V_{REF}$  is defined as the “reference landing speed”. Under this definition reference landing speed means “the speed of the aeroplane, in a specified landing configuration, at the point where it descends through the landing screen height in the determination of the landing distance for manual landings”.*

- c) the constant approach configuration as used in the airworthiness certification tests, but with the landing gear down, shall be maintained throughout the approach reference procedure;
- d) the mass of the aeroplane at the touchdown shall be the maximum landing mass permitted in the approach configuration defined in 3.6.3 c) at which noise certification is requested; and
- e) the most critical (that which produces the highest noise level) configuration with normal deployment of aerodynamic control surfaces including lift and drag producing devices, at the mass at which certification is requested shall be used. This configuration includes all those items listed in 5.2.5 of Appendix 2 that will contribute to the noisiest continuous state at the maximum landing mass in normal operation.

### 3.7 Test procedures

3.7.1 The test procedures shall be acceptable to the airworthiness and noise certifying authority of the State issuing the certificate.

3.7.2 The test procedures and noise measurements shall be conducted and processed in an approved manner to yield the noise evaluation measure designated as effective perceived noise level, EPNL, in units of EPNdB, as described in Appendix 2.

3.7.3 Acoustic data shall be adjusted by the methods outlined in Appendix 2 to the reference conditions specified in this chapter. Adjustments for speed and thrust shall be made as described in Section 8 of Appendix 2.

3.7.4 If the mass during the test is different from the mass at which the noise certification is requested, the necessary EPNL adjustment shall not exceed 2 EPNdB for take-offs and 1 EPNdB for approaches. Data approved by the certifying authority shall be used to determine the variation of EPNL with mass for both take-off and approach test conditions. Similarly the necessary EPNL adjustment for variations in approach flight path from the reference flight path shall not exceed 2 EPNdB.

3.7.5 For the approach conditions the test procedures shall be accepted if the aeroplane follows a steady glide path angle of  $3^\circ \pm 0.5^\circ$ .

3.7.6 If equivalent test procedures different from the reference procedures are used, the test procedures and all methods for adjusting the results to the reference procedures shall be approved by the certifying authority. The amounts of the adjustments shall not exceed 16 EPNdB on take-off and 8 EPNdB on approach, and if the adjustments are more than 8 EPNdB and 4 EPNdB, respectively, the resulting numbers shall be more than 2 EPNdB below the noise limits specified in 3.4.

*Note.— Guidance material on the use of equivalent procedures is provided in the Environmental Technical Manual (Doc 9501), Volume I — Procedures for the Noise Certification of Aircraft.*



3.7.7 For take-off, lateral, and approach conditions, the variation in instantaneous indicated airspeed of the aeroplane shall be maintained within  $\pm 3$  per cent of the average airspeed between the 10 dB-down points. This shall be determined by reference to the pilot's airspeed indicator. However, when the instantaneous indicated airspeed varies from the average airspeed over the 10 dB-down points by more than  $\pm 5.5$  km/h ( $\pm 3$  kt), and this is judged by the certificating authority representative on the flight deck to be due to atmospheric turbulence, then the flight so affected shall be rejected for noise certification purposes.



## CHAPTER 4.

- 1.— **SUBSONIC JET AEROPLANES AND PROPELLER-DRIVEN AEROPLANES WITH MAXIMUM CERTIFICATED TAKE-OFF MASS 55 000 kg AND OVER — Application for Type Certificate submitted on or after 1 January 2006 and before 31 December 2017**
- 2.— **SUBSONIC JET AEROPLANES WITH MAXIMUM CERTIFICATED TAKE-OFF MASS LESS THAN 55 000 kg — Application for Type Certificate submitted on or after 1 January 2006 and before 31 December 2020**
- 3.— **PROPELLER-DRIVEN AEROPLANES WITH MAXIMUM CERTIFICATED TAKE-OFF MASS OVER 8 618 kg AND LESS THAN 55 000 kg — Application for Type Certificate submitted on or after 1 January 2006 and before 31 December 2020**

### 4.1 Applicability

*Note.*— See also Chapter 1, 1.10, 1.11, 1.12 and 1.13.

4.1.1 The Standards of this chapter shall, with the exception of those aeroplanes which require a runway<sup>1</sup> length of 610 m or less at maximum certificated mass for airworthiness or propeller-driven aeroplanes specifically designed and used for agricultural or firefighting purposes, be applicable to:

- a) all subsonic jet aeroplanes and propeller-driven aeroplanes, including their derived versions, with a maximum certificated take-off mass of 55 000 kg and over for which the application for a Type Certificate was submitted on or after 1 January 2006 and before 31 December 2017;
- b) all subsonic jet aeroplanes, including their derived versions, with a maximum certificated take-off mass of less than 55 000 kg for which the application for a Type Certificate was submitted on or after 1 January 2006 and before 31 December 2020;
- c) all propeller-driven aeroplanes, including their derived versions, with a maximum certificated take-off mass of over 8 618 kg and less than 55 000 kg, for which the application for a Type Certificate was submitted on or after 1 January 2006 and before 31 December 2020; and
- d) all subsonic jet aeroplanes and all propeller-driven aeroplanes certificated originally as satisfying Annex 16, Volume I, Chapter 3 or Chapter 5, for which recertification to Chapter 4 is requested.

*Note.*— *Guidance material on applications for recertification is provided in the Environmental Technical Manual (Doc 9501), Volume I — Procedures for the Noise Certification of Aircraft.*

---

1. With no stopway or clearway.

4.1.2 Notwithstanding 4.1.1, it may be recognized by a Contracting State that the following situations for jet aeroplanes and propeller-driven aeroplanes over 8 618 kg maximum certificated take-off mass on its registry do not require demonstration of compliance with the provisions of the Standards of Annex 16, Volume I:

- a) gear down flight with one or more retractable landing gear down during the entire flight;
- b) spare engine and nacelle carriage external to the skin of the aeroplane (and return of the pylon or other external mount); and
- c) time-limited engine and/or nacelle changes, where the change in type design specifies that the aeroplane may not be operated for a period of more than 90 days unless compliance with the provisions of Annex 16, Volume I, is shown for that change in type design. This applies only to changes resulting from a required maintenance action.

## 4.2 Noise measurements

### 4.2.1 Noise evaluation measure

The noise evaluation measure shall be the effective perceived noise level in EPNdB as described in Appendix 2.

## 4.3 Reference noise measurement points

4.3.1 An aeroplane, when tested in accordance with these Standards, shall not exceed the maximum noise level specified in 4.4 of the noise measured at the points specified in Chapter 3, 3.3.1 a), b) and c).

### 4.3.2 Test noise measurement points

The provisions of Chapter 3, 3.3.2, relating to test noise measurement points shall apply.

## 4.4 Maximum noise levels

4.4.1 The maximum permitted noise levels are defined in Chapter 3, 3.4.1.1, 3.4.1.2 and 3.4.1.3, and shall not be exceeded at any of the measurement points.

4.4.1.1 The sum of the differences at all three measurement points between the maximum noise levels and the maximum permitted noise levels specified in Chapter 3, 3.4.1.1, 3.4.1.2 and 3.4.1.3, shall not be less than 10 EPNdB.

4.4.1.2 The sum of the differences at any two measurement points between the maximum noise levels and the corresponding maximum permitted noise levels specified in Chapter 3, 3.4.1.1, 3.4.1.2 and 3.4.1.3, shall not be less than 2 EPNdB.

*Note.*— See Attachment A for equations for the calculation of maximum permitted noise levels as a function of take-off mass.

#### **4.5 Noise certification reference procedures**

The noise certification reference procedures shall be as specified in Chapter 3, 3.6.

#### **4.6 Test procedures**

The test procedures shall be as specified in Chapter 3, 3.7.

#### **4.7 Recertification**

For aeroplanes specified in 4.1.1 c), recertification shall be granted on the basis that the evidence used to determine compliance with Chapter 4 is as satisfactory as the evidence associated with aeroplanes specified in 4.1.1 a) and b).

---



## **CHAPTER 5. PROPELLER-DRIVEN AEROPLANES OVER 8 618 kg — Application for Type Certificate submitted before 1 January 1985**

### **5.1 Applicability**

*Note 1.— See also Chapter 1, 1.10, 1.11, 1.12 and 1.13.*

*Note 2.— See Attachment E for guidance on interpretation of these applicability provisions.*

5.1.1 The Standards defined hereunder are not applicable to:

- a) aeroplanes requiring a runway<sup>1</sup> length of 610 m or less at maximum certificated mass for airworthiness;
- b) aeroplanes specifically designed and used for firefighting purposes; and
- c) aeroplanes specifically designed and used for agricultural purposes.

5.1.2 The Standards of this chapter shall be applicable to all propeller-driven aeroplanes, including their derived versions, of over 8 618 kg maximum certificated take-off mass for which either the application for a Type Certificate was submitted on or after 6 October 1977 and before 1 January 1985.

5.1.3 The Standards of Chapter 2, with the exception of Sections 2.1 and 2.4.2, shall be applicable to propeller-driven aeroplanes of over 8 618 kg for which the application for a Type Certificate was submitted before 6 October 1977 and which are either:

- a) derived versions for which the application for certification of the change in type design was submitted on or after 6 October 1977; or
- b) individual aeroplanes for which a certificate of airworthiness was first issued on or after 26 November 1981.

*Note.— The Standards in Chapters 2 and 3 although developed previously for subsonic jet aeroplanes are considered suitable for application to other aeroplane types regardless of the type of power installed.*

5.1.4 Notwithstanding 5.1.2 and 5.1.3, it may be recognized by a Contracting State that the following situations for jet aeroplanes, and propeller-driven aeroplanes over 8 618 kg maximum certificated take-off mass on its registry do not require demonstration of compliance with the provisions of the Standards of Annex 16, Volume I:

- a) gear down flight with one or more retractable landing gear down during the entire flight;
- b) spare engine and nacelle carriage external to the skin of the aeroplane (and return of the pylon or other external mount); and
- c) time-limited engine and/or nacelle changes, where the change in type design specifies that the aeroplane may not be operated for a period of more than 90 days unless compliance with the provisions of Annex 16, Volume I, is shown for that change in type design. This applies only to changes resulting from a required maintenance action.

---

1. With no stopway or clearway.

## 5.2 Noise measurements

### 5.2.1 Noise evaluation measure

The noise evaluation measure shall be the effective perceived noise level in EPNdB as described in Appendix 2.

## 5.3 Noise measurement points

### 5.3.1 Reference noise measurement points

An aeroplane, when tested in accordance with these Standards, shall not exceed the noise levels specified in 5.4 at the following points:

- a) *lateral reference noise measurement point*: the point on a line parallel to and 450 m from the runway centre line, or extended runway centre line, where the noise level is a maximum during take-off;
- b) *flyover reference noise measurement point*: the point on the extended centre line of the runway and at a distance of 6.5 km from the start of roll; and
- c) *approach reference noise measurement point*: the point on the ground, on the extended centre line of the runway, 2 000 m from the threshold. On level ground this corresponds to a position 120 m (394 ft) vertically below the 3° descent path originating from a point 300 m beyond the threshold.

### 5.3.2 Test noise measurement points

5.3.2.1 If the test noise measurement points are not located at the reference noise measurement points, any corrections for the difference in position shall be made in the same manner as the corrections for the differences between test and reference flight paths.

5.3.2.2 Sufficient lateral test noise measurement points shall be used to demonstrate to the certifying authority that the maximum noise level on the appropriate lateral line has been clearly determined. Simultaneous measurements shall be made at one test noise measurement point at a symmetrical position on the other side of the runway.

5.3.2.3 The applicant shall demonstrate to the certifying authority that during flight test, lateral and flyover noise levels were not separately optimized at the expense of each other.

## 5.4 Maximum noise levels

The maximum noise levels, when determined in accordance with the noise evaluation method of Appendix 2, shall not exceed the following:

- a) *at lateral reference noise measurement point*: 96 EPNdB constant limit for aeroplanes with maximum take-off mass, at which the noise certification is requested, up to 34 000 kg and increasing linearly with the logarithm of aeroplane mass at the rate of 2 EPNdB per doubling of mass from that point until the limit of 103 EPNdB is reached, after which the limit is constant;



- b) *at flyover reference noise measurement point*: 89 EPNdB constant limit for aeroplanes with maximum take-off mass, at which the noise certification is requested, up to 34 000 kg and increasing linearly with the logarithm of aeroplane mass at the rate of 5 EPNdB per doubling of mass from that point until the limit of 106 EPNdB is reached, after which the limit is constant; and
- c) *at approach reference noise measurement point*: 98 EPNdB constant limit for aeroplanes with maximum take-off mass, at which the noise certification is requested, up to 34 000 kg and increasing linearly with the logarithm of aeroplane mass at the rate of 2 EPNdB per doubling of mass from that point until the limit of 105 EPNdB is reached, after which the limit is constant.

*Note.*— See Attachment A for equations for the calculation of maximum permitted noise levels as a function of take-off mass.

### 5.5 Trade-offs

If the maximum noise levels are exceeded at one or two measurement points:

- a) the sum of excesses shall not be greater than 3 EPNdB;
- b) any excess at any single point shall not be greater than 2 EPNdB; and
- c) any excesses shall be offset by corresponding reductions at the other point or points.

### 5.6 Noise certification reference procedures

#### 5.6.1 General conditions

5.6.1.1 The reference procedures shall comply with the appropriate airworthiness requirements.

5.6.1.2 The calculations of reference procedures and flight paths shall be approved by the certifying authority.

5.6.1.3 Except in conditions specified in 5.6.1.4, the take-off and approach reference procedures shall be those defined in 5.6.2 and 5.6.3, respectively.

5.6.1.4 When it is shown by the applicant that the design characteristics of the aeroplane would prevent flight being conducted in accordance with 5.6.2 and 5.6.3, the reference procedures shall:

- a) depart from the reference procedures defined in 5.6.2 and 5.6.3 only to the extent demanded by those design characteristics which make compliance with the procedures impossible; and
- b) be approved by the certifying authority.

5.6.1.5 The reference procedures shall be calculated under the following reference atmospheric conditions:

- a) atmospheric pressure at sea level of 1 013.25 hPa, decreasing with altitude at a rate defined by the ICAO Standard Atmosphere;
- b) ambient air temperature at sea level of 25°C, decreasing with altitude at a rate defined by the ICAO Standard Atmosphere (i.e. 0.65°C per 100 m), except that at the discretion of the certifying authority, an alternative ambient air temperature at sea level of 15°C may be used;

- c) constant relative humidity of 70 per cent;
- d) zero wind; and
- e) the reference atmosphere in terms of temperature and relative humidity is considered to be homogeneous (i.e. ambient temperature 25°C and relative humidity 70 per cent) for the purpose of calculating:
  - 1) the reference sound attenuation rate due to atmospheric absorption; and
  - 2) the reference speed of sound used in the calculation of the reference sound propagation geometry.

*Note 1.— Details for calculating the variation of reference atmospheric pressure with altitude are given in the section of the Environmental Technical Manual (Doc 9501), Volume I — Procedures for the Noise Certification of Aircraft, concerning the ICAO Standard Atmosphere.*

*Note 2.— The characteristics of the ICAO Standard Atmosphere are provided in the Manual of the ICAO Standard Atmosphere (extended to 80 kilometres (262 500 feet) (Doc 7488/3).*

#### 5.6.2 Take-off reference procedure

The take-off flight path shall be calculated as follows:

- a) average take-off power shall be used from the start of take-off to the point where at least the height above runway level shown below is reached. The take-off power used shall be the maximum available for normal operations as scheduled in the performance section of the aeroplane flight manual for the reference atmospheric conditions given in 5.6.1.5;
  - 1) aeroplanes with two engines or less — 300 m (984 ft);
  - 2) aeroplanes with three engines — 260 m (853 ft);
  - 3) aeroplanes with four engines or more — 210 m (689 ft);
- b) upon reaching the height specified in a) above, the power shall not be reduced below that required to maintain:
  - 1) a climb gradient of 4 per cent; or
  - 2) in the case of multi-engined aeroplanes, level flight with one engine inoperative;whichever power is the greater;
- c) the speed shall be the all-engines operating take-off climb speed selected by the applicant for use in normal operation, which shall be at least  $V_2 + 19$  km/h ( $V_2 + 10$  kt) and which shall be attained as soon as practicable after lift-off and be maintained throughout the take-off noise certification test;
- d) a constant take-off configuration selected by the applicant shall be maintained throughout the take-off reference procedure except that the landing gear may be retracted; and
- e) the mass of the aeroplane at the brake release shall be the maximum take-off mass at which the noise certification is requested.

### 5.6.3 Approach reference procedure

The approach reference flight path shall be calculated as follows:

- a) the aeroplane shall be stabilized and following a  $3^\circ$  glide path;
- b) the approach shall be made at a stabilized airspeed of not less than  $1.3 V_S + 19$  km/h ( $1.3 V_S + 10$  kt) with power stabilized during approach and over the measuring point and continued to a normal touchdown;
- c) the constant approach configuration used in the airworthiness certification test, but with the landing gear down, shall be maintained throughout the approach reference procedure;
- d) the mass of the aeroplane at the touchdown shall be the maximum landing mass permitted in the approach configuration defined in 5.6.3 c) at which noise certification is requested; and
- e) the most critical (that which produces the highest noise levels) configuration at the mass at which certification is requested shall be used.

## 5.7 Test procedures

5.7.1 The test procedures shall be acceptable to the airworthiness and noise certifying authority of the State issuing the certificate.

5.7.2 The test procedures and noise measurements shall be conducted and processed in an approved manner to yield the noise evaluation measure designated as effective perceived noise level, EPNL, in units of EPNdB, as described in Appendix 2.

5.7.3 Acoustic data shall be adjusted by the methods outlined in Appendix 2 to the reference conditions specified in this chapter. Adjustments for speed and thrust shall be made as described in Section 8 of Appendix 2.

5.7.4 If the mass during the test is different from the mass at which the noise certification is requested, the necessary EPNL adjustment shall not exceed 2 EPNdB for take-offs and 1 EPNdB for approaches. Data approved by the certifying authority shall be used to determine the variation of EPNL with mass for both take-off and approach test conditions. Similarly, the necessary EPNL adjustment for variations in approach flight path from the reference flight path shall not exceed 2 EPNdB.

5.7.5 For the approach conditions the test procedures shall be accepted if the aeroplane follows a steady glide path angle of  $3^\circ \pm 0.5^\circ$ .

5.7.6 If equivalent test procedures different from the reference procedures are used, the test procedures and all methods for adjusting the results to the reference procedures shall be approved by the certifying authority. The amounts of the adjustments shall not exceed 16 EPNdB on take-off and 8 EPNdB on approach, and if the adjustments are more than 8 EPNdB and 4 EPNdB, respectively, the resulting numbers shall not be within 2 EPNdB of the limit noise levels specified in 5.4.

*Note.*— Guidance material on the use of equivalent procedures is provided in the Environmental Technical Manual (Doc 9501), Volume I — Procedures for the Noise Certification of Aircraft.



## **CHAPTER 6. PROPELLER-DRIVEN AEROPLANES NOT EXCEEDING 8 618 kg — Application for Type Certificate submitted before 17 November 1988**

### **6.1 Applicability**

*Note 1.— See also Chapter 1, 1.10, 1.11, 1.12 and 1.13.*

*Note 2.— See Attachment E for guidance on interpretation of these applicability provisions.*

The Standards of this chapter shall be applicable to all propeller-driven aeroplanes, except those aeroplanes specifically designed and used for aerobatic, agricultural or firefighting purposes, having a maximum certificated take-off mass not exceeding 8 618 kg for which either:

- a) the application for the Type Certificate was submitted on or after 1 January 1975 and before 17 November 1988, except for derived versions for which the application for certification of the change in type design was submitted on or after 17 November 1988, in which case the Standards of Chapter 10 apply; or
- b) a certificate of airworthiness for the individual aeroplane was first issued on or after 1 January 1980.

### **6.2 Noise evaluation measure**

The noise evaluation measure shall be a weighted overall sound pressure level as defined in International Electrotechnical Commission (IEC) Publication No. 179.<sup>1</sup> The weighting applied to each sinusoidal component of the sound pressure shall be given as a function of frequency by the standard reference curve called “A”.

### **6.3 Maximum noise levels**

For aeroplanes specified in 6.1 a) and b), the maximum noise levels, when determined in accordance with the noise evaluation method of Appendix 3, shall not exceed the following:

- a 68 dB(A) constant limit up to an aeroplane mass of 600 kg, varying linearly with mass from that point to 1 500 kg, after which the limit is constant at 80 dB(A) up to 8 618 kg.

*Note 1.— Where an aeroplane comes within the provisions of Chapter 10, 10.1.2, the limit of 80 dB(A) applies up to 8 618 kg.*

*Note 2.— See Attachment A for equations for the calculation of maximum permitted noise levels as a function of take-off mass.*

---

1. As amended. Available from the Central Office of the International Electrotechnical Commission, 3 rue de Varembeé, Geneva, Switzerland.

#### 6.4 Noise certification reference procedures

The reference procedures shall be calculated under the following reference atmospheric conditions:

- a) atmospheric pressure at sea level of 1 013.25 hPa, decreasing with altitude at a rate defined by the ICAO Standard Atmosphere; and
- b) ambient air temperature at sea level of 25°C, decreasing with altitude at a rate defined by the ICAO Standard Atmosphere (i.e. 0.65°C per 100 m);

*Note 1.— Details for calculating the variation of reference atmospheric pressure with altitude are given in the section of the Environmental Technical Manual (Doc 9501), Volume I — Procedures for the Noise Certification of Aircraft, concerning the ICAO Standard Atmosphere.*

*Note 2.— The characteristics of the ICAO Standard Atmosphere are provided in the Manual of the ICAO Standard Atmosphere (extended to 80 kilometres (262 500 feet)(Doc 7488/3).*

#### 6.5 Test procedures

6.5.1 Either the test procedures described in 6.5.2 and 6.5.3 or equivalent test procedures approved by the certifying authority shall be used.

6.5.2 Tests to demonstrate compliance with the maximum noise levels of 6.3 shall consist of a series of level flights overhead the measuring station at a height of

$$300 \begin{matrix} +10 \\ -30 \end{matrix} \text{ m (984 } \begin{matrix} +30 \\ -100 \end{matrix} \text{ ft)}$$

The aeroplane shall pass over the measuring point within  $\pm 10^\circ$  from the vertical.

6.5.3 Overflight shall be performed at the highest power in the normal operating range,<sup>2</sup> stabilized airspeed and with the aeroplane in the cruise configuration.

*Note.— Guidance material on the use of equivalent procedures is provided in the Environmental Technical Manual (Doc 9501), Volume I — Procedures for the Noise Certification of Aircraft.*

---

2. This is normally indicated in the aeroplane flight manual and on the flight instruments.

## CHAPTER 7. PROPELLER-DRIVEN STOL AEROPLANES

*Note.— Standards and Recommended Practices for this chapter are not yet developed. In the meantime, guidelines provided in Attachment B may be used for noise certification of propeller-driven STOL aeroplanes for which a certificate of airworthiness for the individual aeroplane was first issued on or after 1 January 1976.*

---





## CHAPTER 8. HELICOPTERS

### 8.1 Applicability

*Note.— See also Chapter 1, 1.10, 1.11, 1.12 and 1.13.*

8.1.1 The Standards of this chapter shall be applicable to all helicopters for which 8.1.2, 8.1.3 and 8.1.4 apply, except those specifically designed and used for agricultural, firefighting or external load-carrying purposes.

8.1.2 For a helicopter for which the application for the Type Certificate was submitted on or after 1 January 1985, except for those helicopters specified in 8.1.4, the maximum noise levels of 8.4.1 shall apply.

8.1.3 For a derived version of a helicopter for which the application for certification of the change in type design was submitted on or after 17 November 1988, except for those helicopters specified in 8.1.4, the maximum noise levels of 8.4.1 shall apply.

8.1.4 For all helicopters, including their derived versions, for which the application for the Type Certificate was submitted on or after 21 March 2002, the maximum noise levels of 8.4.2 shall apply.

8.1.5 Certification of helicopters which are capable of carrying external loads or external equipment shall be made without such loads or equipment fitted.

*Note.— Helicopters which comply with the Standards with internal loads may be excepted when carrying external loads or external equipment, if such operations are conducted at a gross mass or with other operating parameters which are in excess of those certificated for airworthiness with internal loads.*

8.1.6 An applicant under 8.1.1 may alternatively elect to show compliance with Chapter 11 instead of Chapter 8 if the helicopter has a maximum certificated take-off mass of 3 175 kg or less.

### 8.2 Noise evaluation measure

The noise evaluation measure shall be the effective perceived noise level in EPNdB as described in Appendix 2.

### 8.3 Reference noise measurement points

A helicopter, when tested in accordance with these Standards, shall not exceed the noise levels specified in 8.4 at the following points:

a) *Take-off reference noise measurement points*

- 1) a flight path reference point located on the ground vertically below the flight path defined in the take-off reference procedure and 500 m horizontally in the direction of flight from the point at which transition to climbing flight is initiated in the reference procedure (see 8.6.2);

- 2) two other points on the ground symmetrically disposed at 150 m on both sides of the flight path defined in the take-off reference procedure and lying on a line through the flight path reference point.
- b) *Overflight reference noise measurement points*
- 1) a flight path reference point located on the ground 150 m (492 ft) vertically below the flight path defined in the overflight reference procedure (see 8.6.3.1);
  - 2) two other points on the ground symmetrically disposed at 150 m on both sides of the flight path defined in the overflight reference procedure and lying on a line through the flight path reference point.
- c) *Approach reference noise measurement points*
- 1) a flight path reference point located on the ground 120 m (394 ft) vertically below the flight path defined in the approach reference procedure (see 8.6.4). On level ground, this corresponds to a position 1 140 m from the intersection of the 6.0° approach path with the ground plane;
  - 2) two other points on the ground symmetrically disposed at 150 m on both sides of the flight path defined in the approach reference procedure and lying on a line through the flight path reference point.

*Note.*— See Attachment H (Guidelines for Obtaining Helicopter Noise Data for Land-use Planning Purposes) that defines acceptable supplemental land-use planning (LUP) data procedures.

## 8.4 Maximum noise levels

8.4.1 For helicopters specified in 8.1.2 and 8.1.3, the maximum noise levels, when determined in accordance with the noise evaluation method of Appendix 2, shall not exceed the following:

8.4.1.1 *For take-off:* 109 EPNdB for helicopters with maximum certificated take-off mass, at which the noise certification is requested, of 80 000 kg and over and decreasing linearly with the logarithm of the helicopter mass at a rate of 3 EPNdB per halving of mass down to 89 EPNdB after which the limit is constant.

8.4.1.2 *For overflight:* 108 EPNdB for helicopters with maximum certificated take-off mass, at which the noise certification is requested, of 80 000 kg and over and decreasing linearly with the logarithm of the helicopter mass at a rate of 3 EPNdB per halving of mass down to 88 EPNdB after which the limit is constant.

8.4.1.3 *For approach:* 110 EPNdB for helicopters with maximum certificated take-off mass, at which the noise certification is requested, of 80 000 kg and over and decreasing linearly with the logarithm of the helicopter mass at a rate of 3 EPNdB per halving of mass down to 90 EPNdB after which the limit is constant.

*Note.*— See Attachment A for equations for the calculation of maximum permitted noise levels as a function of take-off mass.

8.4.2 For helicopters specified in 8.1.4, the maximum noise levels, when determined in accordance with the noise evaluation method of Appendix 2, shall not exceed the following:

8.4.2.1 *For take-off:* 106 EPNdB for helicopters with maximum certificated take-off mass, at which the noise certification is requested, of 80 000 kg and over and decreasing linearly with the logarithm of the helicopter mass at a rate of 3 EPNdB per halving of mass down to 86 EPNdB after which the limit is constant.

8.4.2.2 *For overflight:* 104 EPNdB for helicopters with maximum certificated take-off mass, at which the noise certification is requested, of 80 000 kg and over and decreasing linearly with the logarithm of the helicopter mass at a rate of 3 EPNdB per halving of mass down to 84 EPNdB after which the limit is constant.

8.4.2.3 *For approach:* 109 EPNdB for helicopters with maximum certificated take-off mass, at which the noise certification is requested, of 80 000 kg and over and decreasing linearly with the logarithm of the helicopter mass at a rate of 3 EPNdB per halving of mass down to 89 EPNdB after which the limit is constant.

## 8.5 Trade-offs

If the noise level limits are exceeded at one or two measurement points:

- a) the sum of excesses shall not be greater than 4 EPNdB;
- b) any excess at any single point shall not be greater than 3 EPNdB; and
- c) any excess shall be offset by corresponding reductions at the other point or points.

## 8.6 Noise certification reference procedures

### 8.6.1 General conditions

8.6.1.1 The reference procedures shall comply with the appropriate airworthiness requirements.

8.6.1.2 The reference procedures and flight paths shall be approved by the certificating authority.

8.6.1.3 Except in conditions specified in 8.6.1.4, the take-off, overflight and approach reference procedures shall be those defined in 8.6.2, 8.6.3 and 8.6.4, respectively.

8.6.1.4 When it is shown by the applicant that the design characteristics of the helicopter would prevent flight being conducted in accordance with 8.6.2, 8.6.3 or 8.6.4, the reference procedures shall:

- a) depart from the reference procedures defined in 8.6.2, 8.6.3 or 8.6.4 only to the extent demanded by those design characteristics which make compliance with the reference procedures impossible; and
- b) be approved by the certificating authority.

8.6.1.5 The reference procedures shall be calculated under the following reference atmospheric conditions:

- a) constant atmospheric pressure of 1 013.25 hPa;
- b) constant ambient air temperature of 25°C;
- c) constant relative humidity of 70 per cent; and
- d) zero wind.

8.6.1.6 In 8.6.2 c), 8.6.3.1 c) and 8.6.4 c), the maximum normal operating rpm shall be taken as the highest rotor speed for each reference procedure corresponding to the airworthiness limit imposed by the manufacturer and approved by the certificating authority. Where a tolerance on the highest rotor speed is specified, the maximum normal operating rotor speed shall be taken as the highest rotor speed about which that tolerance is given. If the rotor speed is automatically linked with flight condition, the maximum normal operating rotor speed corresponding with the reference flight condition shall be used during the noise certification procedure. If rotor speed can be changed by pilot action, the maximum normal operating rotor speed specified in the flight manual limitation section for the reference conditions shall be used during the noise certification procedure.

### 8.6.2 Take-off reference procedure

The take-off reference flight procedure shall be established as follows:

- a) the helicopter shall be stabilized at the maximum take-off power corresponding to minimum installed engine(s) specification power available for the reference ambient conditions or gearbox torque limit, whichever is lower, and along a path starting from a point located 500 m prior to the flight path reference point, at 20 m (65 ft) above the ground;
- b) the best rate of climb speed,  $V_Y$ , or the lowest approved speed for the climb after take-off, whichever is the greater, shall be maintained throughout the take-off reference procedure;
- c) the steady climb shall be made with the rotor speed stabilized at the maximum normal operating rpm certificated for take-off;
- d) a constant take-off configuration selected by the applicant shall be maintained throughout the take-off reference procedure with the landing gear position consistent with the airworthiness certification tests for establishing the best rate of climb speed,  $V_Y$ ;
- e) the mass of the helicopter shall be the maximum take-off mass at which noise certification is requested; and
- f) the reference take-off path is defined as a straight line segment inclined from the starting point (500 m prior to the centre microphone location and 20 m (65 ft) above ground level) at an angle defined by best rate of climb and  $V_Y$  for minimum specification engine performance.

### 8.6.3 Overflight reference procedure

8.6.3.1 The overflight reference procedure shall be established as follows:

- a) the helicopter shall be stabilized in level flight overhead the flight path reference point at a height of 150 m (492 ft);
- b) a speed of  $0.9 V_H$  or  $0.9 V_{NE}$  or  $0.45 V_H + 120 \text{ km/h}$  ( $0.45 V_H + 65 \text{ kt}$ ) or  $0.45 V_{NE} + 120 \text{ km/h}$  ( $0.45 V_{NE} + 65 \text{ kt}$ ), whichever is the least, shall be maintained throughout the overflight reference procedure;

*Note.— For noise certification purposes,  $V_H$  is defined as the airspeed in level flight obtained using the torque corresponding to minimum engine installed, maximum continuous power available for sea level pressure (1 013.25 hPa), 25°C ambient conditions at the relevant maximum certificated mass.  $V_{NE}$  is defined as the not-to-exceed airworthiness airspeed imposed by the manufacturer and approved by the certificating authority.*

- c) the overflight shall be made with the rotor speed stabilized at the maximum normal operating rpm certificated for level flight;

- d) the helicopter shall be in the cruise configuration; and
- e) the mass of the helicopter shall be the maximum take-off mass at which noise certification is requested.

8.6.3.2 The value of  $V_H$  and/or  $V_{NE}$  used for noise certification shall be quoted in the approved flight manual.

#### 8.6.4 Approach reference procedure

The approach reference procedure shall be established as follows:

- a) the helicopter shall be stabilized and following a  $6.0^\circ$  approach path;
- b) the approach shall be made at a stabilized airspeed equal to the best rate of climb speed,  $V_Y$ , or the lowest approved speed for the approach, whichever is the greater, with power stabilized during the approach and over the flight path reference point, and continued to a normal touchdown;
- c) the approach shall be made with the rotor speed stabilized at the maximum normal operating rpm certificated for approach;
- d) the constant approach configuration used in airworthiness certification tests, with the landing gear extended, shall be maintained throughout the approach reference procedure; and
- e) the mass of the helicopter at touchdown shall be the maximum landing mass at which noise certification is requested.

### 8.7 Test procedures

8.7.1 The test procedures shall be acceptable to the airworthiness and noise certificating authority of the State issuing the certificate.

8.7.2 The test procedures and noise measurements shall be conducted and processed in an approved manner to yield the noise evaluation measure designated as effective perceived noise level, EPNL, in units of EPNdB, as described in Appendix 2.

8.7.3 Test conditions and procedures shall be closely similar to reference conditions and procedures or the acoustic data shall be adjusted, by the methods outlined in Appendix 2, to the reference conditions and procedures specified in this chapter.

8.7.4 Adjustments for differences between test and reference flight procedures shall not exceed:

- a) *for take-off*: 4.0 EPNdB, of which the arithmetic sum of  $\Delta_1$  and the term  $-7.5 \log(QK/Q_r K_r)$  from  $\Delta_2$  shall not in total exceed 2.0 EPNdB;
- b) *for overflight or approach*: 2.0 EPNdB.

8.7.5 During the test the average rotor rpm shall not vary from the normal maximum operating rpm by more than  $\pm 1.0$  per cent during the 10 dB-down period.

8.7.6 The helicopter airspeed shall not vary from the reference airspeed appropriate to the flight demonstration by more than  $\pm 9$  km/h ( $\pm 5$  kt) throughout the 10 dB-down period.

8.7.7 The number of level overflights made with a headwind component shall be equal to the number of level overflights made with a tailwind component.

8.7.8 The helicopter shall fly within  $\pm 10^\circ$  or  $\pm 20$  m, whichever is greater, from the vertical above the reference track throughout the 10 dB-down period (see Figure 8-1).

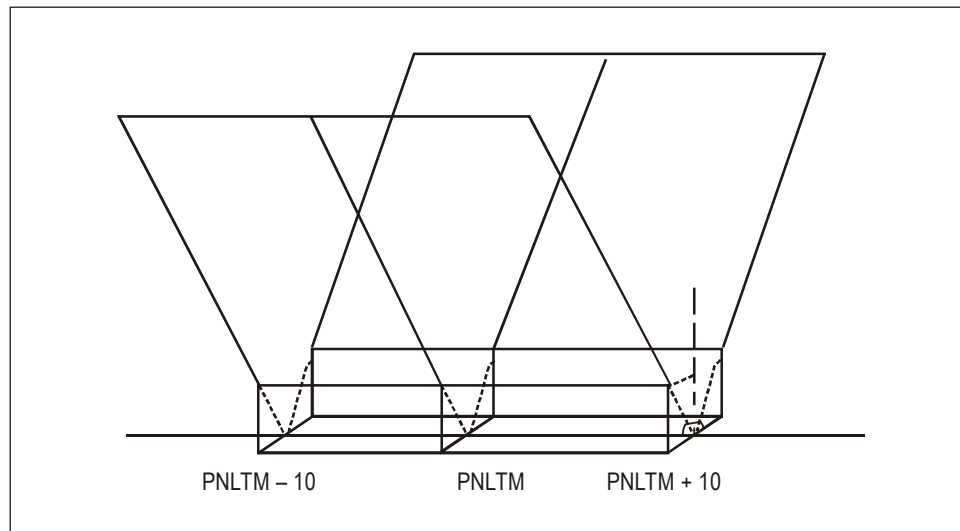

**Figure 8-1. Helicopter lateral deviation tolerances**

8.7.9 The helicopter height shall not vary during overflight from the reference height at the overhead point by more than  $\pm 9$  m ( $\pm 30$  ft).

8.7.10 During the approach noise demonstration the helicopter shall be established on a stabilized constant speed approach within the airspace contained between approach angles of  $5.5^\circ$  and  $6.5^\circ$ .

8.7.11 Tests shall be conducted at a helicopter mass not less than 90 per cent of the relevant maximum certificated mass and may be conducted at a mass not exceeding 105 per cent of the relevant maximum certificated mass. For each of the three flight conditions, at least one test shall be completed at or above this maximum certificated mass.

*Note.*— Guidance material on the use of equivalent procedures is provided in the Environmental Technical Manual (Doc 9501), Volume I — Procedures for the Noise Certification of Aircraft.

## **CHAPTER 9. INSTALLED AUXILIARY POWER UNITS (APU) AND ASSOCIATED AIRCRAFT SYSTEMS DURING GROUND OPERATIONS**

*Note.— Standards and Recommended Practices for this chapter are not yet developed. In the meantime, guidelines provided in Attachment C may be used for noise certification of installed auxiliary power units (APU) and associated aircraft systems in:*

- a) all aircraft for which the application for a Type Certificate was submitted, or another equivalent prescribed procedure was carried out by the certifying authority, on or after 6 October 1977; and*
  - b) aircraft of existing type design for which the application for a change of type design involving the basic APU installation was submitted, or another equivalent prescribed procedure was carried out by the certifying authority, on or after 6 October 1977.*
-





# **CHAPTER 10. PROPELLER-DRIVEN AEROPLANES NOT EXCEEDING 8 618 kg — Application for Type Certificate or Certification of Derived Version submitted on or after 17 November 1988**

## **10.1 Applicability**

*Note 1.— See also Chapter 1, 1.10, 1.11, 1.12 and 1.13.*

*Note 2.— See Attachment E for guidance on interpretation of these applicability provisions.*

10.1.1 The Standards of this chapter shall be applicable to all propeller-driven aeroplanes with a certificated take-off mass not exceeding 8 618 kg, except those aeroplanes specifically designed and used for aerobatic, agricultural or firefighting purposes and self-sustaining powered sailplanes.

10.1.2 For aeroplanes for which the application for the Type Certificate was submitted on or after 17 November 1988, except for those aeroplanes specified in 10.1.6, the maximum noise levels of 10.4 a) shall apply.

10.1.3 For aeroplanes specified in 10.1.2 where the application for the Type Certificate was submitted before 17 November 1993 and which fail to comply with the Standards of this chapter, the Standards of Chapter 6 shall apply.

10.1.4 For derived versions for which the application for certification of the change in type design was submitted on or after 17 November 1988, except for those derived versions specified in 10.1.6, the maximum noise levels of 10.4 a) shall apply.

10.1.5 For derived versions specified in 10.1.4 where the application for certification of the change in type design was submitted before 17 November 1993 and which fail to comply with the Standards of this chapter, the Standards of Chapter 6 shall apply.

10.1.6 For single-engined aeroplanes, except float planes and amphibians:

- a) the maximum noise levels of 10.4 b) shall apply to those aeroplanes, including their derived versions, for which the application for the Type Certificate was submitted on or after 4 November 1999;
- b) the maximum noise levels of 10.4 b) shall apply to those derived versions of aeroplanes for which the application for the Type Certificate was submitted before 4 November 1999 and for which the application for certification of the change in type design was submitted on or after 4 November 1999; except
- c) for those derived versions described in 10.1.6 b) where the application for certification of the change in type design was submitted before 4 November 2004 and which exceed the maximum noise levels of 10.4 b), in which case the maximum noise levels of 10.4 a) shall apply.

## **10.2 Noise evaluation measure**

The noise evaluation measure shall be the maximum A-weighted noise level,  $L_{ASmax}$ , as defined in Appendix 6.

### 10.3 Reference noise measurement points

10.3.1 An aeroplane, when tested in accordance with these Standards, shall not exceed the noise level specified in 10.4 at the take-off reference noise measurement point.

10.3.2 The take-off reference noise measurement point is the point on the extended centre line of the runway at a distance of 2 500 m from the start of take-off roll.

### 10.4 Maximum noise levels

The maximum noise levels determined in accordance with the noise evaluation method of Appendix 6 shall not exceed the following:

- a) for aeroplanes specified in 10.1.2 and 10.1.4, a 76 dB(A) constant limit up to an aeroplane mass of 600 kg varying linearly from that point with the logarithm of aeroplane mass until at 1 400 kg the limit of 88 dB(A) is reached after which the limit is constant up to 8 618 kg; and
- b) for aeroplanes specified in 10.1.4, a 70 dB(A) constant limit up to an aeroplane mass of 570 kg increasing linearly from that point with the logarithm of aeroplane mass until at 1 500 kg the limit of 85 dB(A) is reached after which the limit is constant up to 8 618 kg.

*Note.*— See Attachment A for equations for the calculation of maximum permitted noise levels as a function of take-off mass.

### 10.5 Noise certification reference procedures

#### 10.5.1 General conditions

10.5.1.1 The calculations of reference procedures and flight paths shall be approved by the certificating authority.

10.5.1.2 Except in conditions specified in 10.5.1.3, the take-off reference procedure shall be that defined in 10.5.2.

10.5.1.3 When it is shown by the applicant that the design characteristics of the aeroplane would prevent flights being conducted in accordance with 10.5.2, the reference procedures shall:

- a) depart from the reference procedures defined only to the extent demanded by those design characteristics which make compliance with the procedures impossible; and
- b) be approved by the certificating authority.

10.5.1.4 The reference procedures shall be calculated under the following atmospheric conditions:

- a) atmospheric pressure at sea level of 1 013.25 hPa, decreasing with altitude at a rate defined by the ICAO Standard Atmosphere;

- b) ambient air temperature at sea level of 15°C, decreasing with altitude at a rate defined by the ICAO Standard Atmosphere (i.e. 0.65°C per 100 m);
- c) constant relative humidity of 70 per cent; and
- d) zero wind.

*Note 1.*— Details for calculating the variation of reference atmospheric pressure with altitude are given in the section of the Environmental Technical Manual (Doc 9501), Volume I — Procedures for the Noise Certification of Aircraft, concerning the ICAO Standard Atmosphere.

*Note 2.*— The characteristics of the ICAO Standard Atmosphere are provided in the Manual of the ICAO Standard Atmosphere (extended to 80 kilometres (262 500 feet) (Doc 7488/3).

10.5.1.5 The acoustic reference atmospheric conditions shall be the same as the reference atmospheric conditions for flight.

#### 10.5.2 Take-off reference procedure

The take-off flight path shall be calculated taking into account the following two phases.

##### *First phase*

- a) take-off power shall be used from the brake release point to the point at which the height of 15 m (50 ft) above the runway is reached;
- b) a constant take-off configuration selected by the applicant shall be maintained throughout this first phase;
- c) the mass of the aeroplane at the brake release shall be the maximum take-off mass at which the noise certification is requested; and
- d) the length of this first phase shall correspond to the length given in the airworthiness data for a take-off on a level paved runway.

##### *Second phase*

- a) the beginning of the second phase corresponds to the end of the first phase;
- b) the aeroplane shall be in the climb configuration with landing gear up, if retractable, and flap setting corresponding to normal climb throughout this second phase;
- c) the speed shall be the best rate of climb speed,  $V_Y$ ; and
- d) take-off power and, for aeroplanes equipped with variable pitch or constant speed propellers, rpm shall be maintained throughout the second phase. If airworthiness limitations do not permit the application of take-off power and rpm up to the reference point, then take-off power and rpm shall be maintained for as long as is permitted by such limitations and thereafter at maximum continuous power and rpm. Limiting of time for which take-off power and rpm shall be used in order to comply with this chapter shall not be permitted. The reference height shall be calculated assuming climb gradients appropriate to each power setting used.

## 10.6 Test procedures

10.6.1 The test procedures shall be acceptable to the airworthiness and noise certifying authorities of the State issuing the certificate.

10.6.2 The test procedures and noise measurements shall be conducted and processed in an approved manner to yield the noise evaluation measure in units of  $L_{ASmax}$  as described in Appendix 6.

10.6.3 Acoustic data shall be adjusted by the methods outlined in Appendix 6 to the reference conditions specified in this chapter.

10.6.4 If equivalent test procedures are used, the test procedures and all methods for correcting the results to the reference procedures shall be approved by the certifying authority.

*Note.*— *Guidance material on the use of equivalent procedures is provided in the Environmental Technical Manual (Doc 9501), Volume I — Procedures for the Noise Certification of Aircraft.*

## CHAPTER 11. HELICOPTERS NOT EXCEEDING 3 175 kg MAXIMUM CERTIFICATED TAKE-OFF MASS

### 11.1 Applicability

*Note.*— See also Chapter 1, 1.10, 1.11, 1.12 and 1.13.

11.1.1 The Standards of this chapter shall be applicable to all helicopters having a maximum certificated take-off mass not exceeding 3 175 kg for which 11.1.2, 11.1.3 and 11.1.4 apply, except those specifically designed and used for agricultural, firefighting or external load-carrying purposes.

11.1.2 For a helicopter for which the application for the Type Certificate was submitted on or after 11 November 1993, except for those helicopters specified in 11.1.4, the maximum noise levels of 11.4.1 shall apply.

11.1.3 For a derived version of a helicopter for which the application for certification of the change in type design was submitted on or after 11 November 1993, except for those helicopters specified in 11.1.4, the maximum noise levels of 11.4.1 shall apply.

11.1.4 For all helicopters, including their derived versions, for which the application for the Type Certificate was submitted on or after 21 March 2002, the maximum noise levels of 11.4.2 shall apply.

11.1.5 Certification of helicopters which are capable of carrying external loads or external equipment shall be made without such loads or equipment fitted.

*Note.*— Helicopters which comply with the Standards with internal loads may be excepted when carrying external loads or external equipment, if such operations are conducted at a gross mass or with other operating parameters which are in excess of those certificated for airworthiness with internal loads.

11.1.6 An applicant under 11.1.1, 11.1.2, 11.1.3 and 11.1.4 may alternatively elect to show compliance with Chapter 8 instead of complying with this chapter.

### 11.2 Noise evaluation measure

The noise evaluation measure shall be the sound exposure level  $L_{AE}$  as described in Appendix 4.

### 11.3 Reference noise measurement points

A helicopter, when tested in accordance with these Standards, shall not exceed the noise levels specified in 11.4 at a flight path reference point located on the ground 150 m (492 ft) vertically below the flight path defined in the overflight reference procedure (see 11.5.2.1).

*Note.*— See Attachment H (Guidelines for Obtaining Helicopter Noise Data for Land-use Planning Purposes) that defines acceptable supplemental land-use planning (LUP) data procedures.

## 11.4 Maximum noise level

11.4.1 For helicopters specified in 11.1.2 and 11.1.3, the maximum noise levels, when determined in accordance with the noise evaluation method of Appendix 4, shall not exceed 82 dB(A) for helicopters with maximum certificated take-off mass, at which the noise certification is requested, of up to 788 kg and increasing linearly with the logarithm of the helicopter mass at a rate of 3 decibels per doubling of mass thereafter.

11.4.2 For helicopters specified in 11.1.4, the maximum noise levels, when determined in accordance with the noise evaluation method of Appendix 4, shall not exceed 82 dB(A) for helicopters with maximum certificated take-off mass, at which the noise certification is requested, of up to 1 417 kg and increasing linearly with the logarithm of the helicopter mass at a rate of 3 decibels per doubling of mass thereafter.

*Note.— See Attachment A for equations for the calculation of maximum permitted noise levels as a function of take-off mass.*

## 11.5 Noise certification reference procedures

### 11.5.1 General conditions

11.5.1.1 The reference procedure shall comply with the appropriate airworthiness requirements and shall be approved by the certifying authority.

11.5.1.2 Except as otherwise approved, the overflight reference procedures shall be as defined in 11.5.2.

11.5.1.3 When it is shown by the applicant that the design characteristics of the helicopter would prevent flight being conducted in accordance with 11.5.2 the reference procedure shall be permitted to depart from the standard reference procedure, with the approval of the certifying authority, but only to the extent demanded by those design characteristics which make compliance with the reference procedures impossible.

11.5.1.4 The reference procedures shall be established for the following reference atmospheric conditions:

- a) constant atmospheric pressure of 1 013.25 hPa;
- b) constant ambient air temperature of 25°C;
- c) constant relative humidity of 70 per cent; and
- d) zero wind.

11.5.1.5 The maximum normal operating rpm shall be taken as the highest rotor speed corresponding to the airworthiness limit imposed by the manufacturer and approved by the certifying authority for overflight. Where a tolerance on the highest rotor speed is specified, the maximum normal operating rotor speed shall be taken as the highest rotor speed about which that tolerance is given. If rotor speed is automatically linked with flight condition, the maximum normal operating rotor speed corresponding with the reference flight condition shall be used during the noise certification procedure. If rotor speed can be changed by pilot action, the maximum normal operating rotor speed specified in the flight manual limitation section for the reference conditions shall be used during the noise certification procedure.

### 11.5.2 Reference procedure

11.5.2.1 The reference procedure shall be established as follows:

- a) the helicopter shall be stabilized in level flight overhead the flight path reference point at a height of 150 m  $\pm$  15 m (492 ft  $\pm$  50 ft);
- b) a speed of 0.9  $V_H$  or 0.9  $V_{NE}$  or 0.45  $V_H + 120$  km/h (65 kt) or 0.45  $V_{NE} + 120$  km/h (65 kt), whichever is the least, shall be maintained throughout the overflight procedure. For noise certification purposes,  $V_H$  is defined as the airspeed in level flight obtained using the torque corresponding to minimum engine installed, maximum continuous power available for sea level pressure (1 013.25 hPa), 25°C ambient conditions at the relevant maximum certificated mass.  $V_{NE}$  is defined as the not-to-exceed airworthiness airspeed imposed by the manufacturer and approved by the certificating authority;
- c) the overflight shall be made with the rotor speed stabilized at the maximum normal operating rpm certificated for level flight;
- d) the helicopter shall be in the cruise configuration; and
- e) the mass of the helicopter shall be the maximum take-off mass at which noise certification is requested.

11.5.2.2 The value of  $V_H$  and/or  $V_{NE}$  used for noise certification shall be quoted in the approved flight manual.

### 11.6 Test procedures

11.6.1 The test procedures shall be acceptable to the airworthiness and noise certificating authorities of the State issuing the certificate.

11.6.2 The test procedure and noise measurements shall be conducted and processed in an approved manner to yield the noise evaluation measure designated as sound exposure level ( $L_{AE}$ ), in A-weighted decibels integrated over the duration time, as described in Appendix 4.

11.6.3 Test conditions and procedures shall be closely similar to reference conditions and procedures or the acoustic data shall be adjusted, by the methods outlined in Appendix 4, to the reference conditions and procedures specified in this chapter.

11.6.4 During the test, flights shall be made in equal numbers with tailwind and headwind components.

11.6.5 Adjustments for differences between test and reference flight procedures shall not exceed 2.0 dB(A).

11.6.6 During the test, the average rotor rpm shall not vary from the normal maximum operating rpm by more than  $\pm 1.0$  per cent during the 10 dB-down period.

11.6.7 The helicopter airspeed shall not vary from the reference airspeed appropriate to the flight demonstration as described in Appendix 4 by more than  $\pm 5.5$  km/h ( $\pm 3$  kt) throughout the 10 dB-down period.

11.6.8 The helicopter shall fly within  $\pm 10^\circ$  from the vertical above the reference track through the reference noise measurement position.

11.6.9 Tests shall be conducted at a helicopter mass not less than 90 per cent of the relevant maximum certificated mass and may be conducted at a mass not exceeding 105 per cent of the relevant maximum certificated mass.

*Note.*— *Guidance material on the use of equivalent procedures is provided in the Environmental Technical Manual (Doc 9501), Volume I — Procedures for the Noise Certification of Aircraft.*



## CHAPTER 12. SUPERSONIC AEROPLANES

### 12.1 Supersonic aeroplanes — Application for Type Certificate submitted before 1 January 1975

12.1.1 The Standards of Chapter 2 of this Part, with the exception of the maximum noise levels specified in 2.4, shall be applicable to all supersonic aeroplanes, including their derived versions, for which the application for the Type Certificate was submitted before 1 January 1975, and for which a certificate of airworthiness for the individual aeroplane was first issued after 26 November 1981.

12.1.2 The maximum noise levels of those aeroplanes covered by 12.1.1, when determined in accordance with the noise evaluation method of Appendix 1, shall not exceed the measured noise levels of the first certificated aeroplane of the type.

### 12.2 Supersonic aeroplanes — Application for Type Certificate submitted on or after 1 January 1975

*Note.— Standards and Recommended Practices for these aeroplanes have not been developed. However, the maximum noise levels of the Part that would be applicable to subsonic jet aeroplanes may be used as a guideline. Acceptable levels of sonic boom have not been established and compliance with subsonic noise Standards may not be presumed to permit supersonic flight.*



## CHAPTER 13. TILT-ROTORS

*Note.— These Standards are not intended to be used for tilt-rotors that have one or more configurations that are certificated for airworthiness for STOL only. In such cases, different or additional procedures/conditions would likely be needed.*

### 13.1 Applicability

*Note.— See also Chapter 1, 1.10, 1.11, 1.12 and 1.13.*

13.1.1 The Standards of this chapter shall be applicable to all tilt-rotors, including their derived versions, for which the application for a Type Certificate was submitted on or after 1 January 2018.

13.1.2 Noise certification of tilt-rotors which are capable of carrying external loads or external equipment shall be made without such loads or equipment fitted.

### 13.2 Noise evaluation measure

The noise evaluation measure shall be the effective perceived noise level in EPNdB as described in Appendix 2 of this Annex. The correction for spectral irregularities shall start at 50 Hz (see 4.3.1 of Appendix 2).

*Note.— Additional data in  $L_{AE}$  and  $L_{ASmax}$  as defined in Appendix 4, and one-third octave SPLs as defined in Appendix 2 corresponding to  $L_{ASmax}$  should be made available to the certifying authority for land-use planning purposes.*

### 13.3 Noise measurement reference points

A tilt-rotor, when tested in accordance with the reference procedures of 13.6 and the test procedures of 13.7, shall not exceed the noise levels specified in 13.4 at the following reference points:

a) *Take-off reference noise measurement points:*

- 1) a flight path reference point located on the ground vertically below the flight path defined in the take-off reference procedure (see 13.6.2) and 500 m (1 640 ft) horizontally in the direction of flight from the point at which transition to climbing flight is initiated in the reference procedure;
- 2) two other points on the ground symmetrically disposed at 150 m (492 ft) on both sides of the flight path defined in the take-off reference procedure and lying on a line through the flight path reference point.

b) *Overflight reference noise measurement points:*

- 1) a flight path reference point located on the ground 150 m (492 ft) vertically below the flight path defined in the overflight reference procedure (see 13.6.3);

- 2) two other points on the ground symmetrically disposed at 150 m (492 ft) on both sides of the flight path defined in the overflight reference procedure and lying on a line through the flight path reference point.
- c) *Approach reference noise measurement points:*
- 1) a flight path reference point located on the ground 120 m (394 ft) vertically below the flight path defined in the approach reference procedure (see 13.6.4). On level ground, this corresponds to a position 1 140 m (3 740 ft) from the intersection of the 6.0° approach path with the ground plane;
  - 2) two other points on the ground symmetrically disposed at 150 m (492 ft) on both sides of the flight path defined in the approach reference procedure and lying on a line through the flight path reference point.

### 13.4 Maximum noise levels

13.4.1 For tilt-rotors specified in 13.1, the maximum noise levels, when determined in accordance with the noise evaluation method of Appendix 2 for helicopters, shall not exceed the following:

13.4.1.1 *For take-off:* 109 EPNdB for tilt-rotors in VTOL/conversion mode with maximum certificated take-off mass, at which the noise certification is requested, of 80 000 kg and over and decreasing linearly with the logarithm of the tilt-rotor mass at a rate of 3 EPNdB per halving of mass down to 89 EPNdB after which the limit is constant.

13.4.1.2 *For overflight:* 108 EPNdB for tilt-rotors in VTOL/conversion mode with maximum certificated take-off mass, at which the noise certification is requested, of 80 000 kg and over and decreasing linearly with the logarithm of the tilt-rotor mass at a rate of 3 EPNdB per halving of mass down to 88 EPNdB after which the limit is constant.

*Note 1.— For the tilt-rotor in aeroplane mode, there is no maximum noise level.*

*Note 2.— VTOL/conversion mode is all approved configurations and flight modes where the design operating rotor speed is that used for hover operations.*

13.4.1.3 *For approach:* 110 EPNdB for tilt-rotors in VTOL/conversion mode with maximum certificated take-off mass, at which the noise certification is requested, of 80 000 kg and over and decreasing linearly with the logarithm of the tilt-rotor mass at a rate of 3 EPNdB per halving of mass down to 90 EPNdB after which the limit is constant.

*Note.— The equations for the calculation of noise levels as a function of take-off mass presented in Section 7 of Attachment A, for conditions described in Chapter 8, 8.4.1, are consistent with the maximum noise levels defined in 13.4.*

### 13.5 Trade-offs

If the maximum noise levels are exceeded at one or two measurement points:

- a) the sum of excesses shall not be greater than 4 EPNdB;
- b) any excess at any single point shall not be greater than 3 EPNdB; and
- c) any excess shall be offset by corresponding reductions at the other point or points.

### 13.6 Noise certification reference procedures

#### 13.6.1 General conditions

13.6.1.1 The reference procedures shall comply with the appropriate airworthiness requirements.

13.6.1.2 The reference procedures and flight paths shall be approved by the certifying authority.

13.6.1.3 Except in conditions specified in 13.6.1.4, the take-off, overflight and approach reference procedures shall be those defined in 13.6.2, 13.6.3 and 13.6.4, respectively.

13.6.1.4 When it is shown by the applicant that the design characteristics of the tilt-rotor would prevent a flight from being conducted in accordance with 13.6.2, 13.6.3 or 13.6.4, the reference procedures shall:

- a) depart from the reference procedures defined in 13.6.2, 13.6.3 or 13.6.4 only to the extent demanded by those design characteristics which make compliance with the reference procedures impossible; and
- b) be approved by the certifying authority.

13.6.1.5 The reference procedures shall be calculated under the following reference atmospheric conditions:

- a) constant atmospheric pressure of 1 013.25 hPa;
- b) constant ambient air temperature of 25°C, i.e. ISA + 10°C;
- c) constant relative humidity of 70 per cent; and
- d) zero wind.

13.6.1.6 In 13.6.2 d), 13.6.3 d) and 13.6.4 c), the maximum normal operating rpm shall be taken as the highest rotor speed for each reference procedure corresponding to the airworthiness limit imposed by the manufacturer and approved by the certifying authority. Where a tolerance on the highest rotor speed is specified, the maximum normal operating rotor speed shall be taken as the highest rotor speed about which that tolerance is given. If the rotor speed is automatically linked with the flight condition, the maximum normal operating rotor speed corresponding with the reference flight condition shall be used during the noise certification procedure. If the rotor speed can be changed by pilot action, the maximum normal operating rotor speed specified in the flight manual limitation section for the reference conditions shall be used during the noise certification procedure.

#### 13.6.2 Take-off reference procedure

The take-off reference flight procedure shall be established as follows:

- a) a constant take-off configuration, including nacelle angle, selected by the applicant shall be maintained throughout the take-off reference procedure;
- b) the tilt-rotor shall be stabilized at the maximum take-off power corresponding to minimum installed engine(s) specification power available for the reference ambient conditions or gearbox torque limit, whichever is lower, and along a path starting from a point located 500 m (1 640 ft) prior to the flight path reference point, at 20 m (65 ft) above the ground;

- c) the nacelle angle and the corresponding best rate of climb speed, or the lowest approved speed for the climb after take-off, whichever is the greater, shall be maintained throughout the take-off reference procedure;
- d) the steady climb shall be made with the rotor speed stabilized at the maximum normal operating rpm certificated for take-off;
- e) the mass of the tilt-rotor shall be the maximum take-off mass at which noise certification is requested; and
- f) the reference take-off path is defined as a straight line segment inclined from the starting point (500 m (1 640 ft) prior to the centre noise measurement point and 20 m (65 ft) above ground level) at an angle defined by best rate of climb and the best rate of climb speed corresponding to the selected nacelle angle and for minimum specification engine performance.

### 13.6.3 Overflight reference procedure

13.6.3.1 The overflight reference procedure shall be established as follows:

- a) the tilt-rotor shall be stabilized in level flight overhead the flight path reference point at a height of 150 m (492 ft);
- b) a constant configuration selected by the applicant shall be maintained throughout the overflight reference procedures;
- c) the mass of the tilt-rotor shall be the maximum take-off mass at which noise certification is requested;
- d) in the VTOL/conversion mode, the nacelle angle at the authorized fixed operation point that is closest to the lowest nacelle angle certificated for zero airspeed, a speed of  $0.9 V_{CON}$  and a rotor speed stabilized at the maximum normal operating rpm certificated for level flight shall be maintained throughout the overflight reference procedure;

*Note.— For noise certification purposes,  $V_{CON}$  is defined as the maximum authorized speed for VTOL/conversion mode at a specific nacelle angle.*

- e) in the aeroplane mode, the nacelles shall be maintained on the down-stop throughout the overflight reference procedure, with:
  - 1) rotor speed stabilized at the rpm associated with the VTOL/conversion mode and a speed of  $0.9 V_{CON}$ ; and
  - 2) rotor speed stabilized at the normal cruise rpm associated with the aeroplane mode and at the corresponding  $0.9 V_{MCP}$  or  $0.9 V_{MO}$ , whichever is lesser, certificated for level flight.

*Note.— For noise certification purposes,  $V_{MCP}$  is defined as the maximum operating limit airspeed for aeroplane mode corresponding to minimum engine installed, maximum continuous power (MCP) available for sea level pressure (1 013.25 hPa), 25°C ambient conditions at the relevant maximum certificated mass; and  $V_{MO}$  is the maximum operating (MO) limit airspeed that may not be deliberately exceeded.*

13.6.3.2 The values of  $V_{CON}$  and  $V_{MCP}$  or  $V_{MO}$  used for noise certification shall be quoted in the approved flight manual.

### 13.6.4 Approach reference procedure

The approach reference procedure shall be established as follows:

- a) the tilt-rotor shall be stabilized and follow a 6.0° approach path;

- b) the approach shall be in an airworthiness approved configuration in which maximum noise occurs, at a stabilized airspeed equal to the best rate of climb speed corresponding to the nacelle angle, or the lowest approved airspeed for the approach, whichever is the greater, and with power stabilized during the approach and over the flight path reference point, and continued to a normal touchdown;
- c) the approach shall be made with the rotor speed stabilized at the maximum normal operating rpm certificated for approach;
- d) the constant approach configuration used in airworthiness certification tests, with the landing gear extended, shall be maintained throughout the approach reference procedure; and
- e) the mass of the tilt-rotor at touchdown shall be the maximum landing mass at which noise certification is requested.

### 13.7 Test procedures

13.7.1 The test procedures shall be acceptable to the airworthiness and noise certifying authority of the State issuing the certificate.

13.7.2 The test procedures and noise measurements shall be conducted and processed in an approved manner to yield the noise evaluation measure designated in 13.2.

13.7.3 Test conditions and procedures shall be similar to reference conditions and procedures or the acoustic data shall be adjusted, by the methods outlined in Appendix 2 for helicopters, to the reference conditions and procedures specified in this chapter.

13.7.4 Adjustments for differences between test and reference flight procedures shall not exceed:

- a) *for take-off*: 4.0 EPNdB, of which the arithmetic sum of  $\Delta_1$  and the term  $-7.5 \log QK/Q_r K_r$ , from  $\Delta_2$  shall not in total exceed 2.0 EPNdB; and
- b) *for overflight or approach*: 2.0 EPNdB.

13.7.5 During the test the average rotor rpm shall not vary from the normal maximum operating rpm by more than  $\pm 1.0$  per cent throughout the 10 dB-down period.

13.7.6 The airspeed of the tilt-rotor shall not vary from the reference airspeed appropriate to the flight demonstration by more than  $\pm 9$  km/h ( $\pm 5$  kt) throughout the 10 dB-down period.

13.7.7 The number of level overflights made with a headwind component shall be equal to the number of level overflights made with a tailwind component.

13.7.8 The tilt-rotor shall fly within  $\pm 10^\circ$  or  $\pm 20$  m ( $\pm 65$  ft), whichever is greater, from the vertical above the reference track throughout the 10 dB-down period (see Figure 8-1).

13.7.9 The height of the tilt-rotor shall not vary during overflight from the reference height throughout the 10 dB-down period by more than  $\pm 9$  m ( $\pm 30$  ft).

13.7.10 During the approach noise demonstration the tilt-rotor shall be established on a stabilized constant speed approach within the airspace contained between approach angles of  $5.5^\circ$  and  $6.5^\circ$  throughout the 10 dB-down period.

13.7.11 Tests shall be conducted at a tilt-rotor mass not less than 90 per cent of the relevant maximum certificated mass and may be conducted at a mass not exceeding 105 per cent of the relevant maximum certificated mass. For each of the flight conditions, at least one test shall be completed at or above this maximum certificated mass.

---



## CHAPTER 14.

- 1.— **SUBSONIC JET AEROPLANES AND PROPELLER-DRIVEN AEROPLANES WITH MAXIMUM CERTIFICATED TAKE-OFF MASS 55 000 kg AND OVER — Application for Type Certificate submitted on or after 31 December 2017**
- 2.— **SUBSONIC JET AEROPLANES WITH MAXIMUM CERTIFICATED TAKE-OFF MASS LESS THAN 55 000 kg — Application for Type Certificate submitted on or after 31 December 2020**
- 3.— **PROPELLER-DRIVEN AEROPLANES WITH MAXIMUM CERTIFICATED TAKE-OFF MASS OVER 8 618 kg AND LESS THAN 55 000 kg — Application for Type Certificate submitted on or after 31 December 2020**

### 14.1 Applicability

*Note.— See also Chapter 1, 1.10, 1.11, 1.12 and 1.13.*

14.1.1 The Standards of this chapter shall, with the exception of those aeroplanes which require a runway<sup>1</sup> length of 610 m or less at maximum certificated mass for airworthiness or propeller-driven aeroplanes specifically designed and used for agricultural or firefighting purposes, be applicable to:

- a) all subsonic jet aeroplanes and propeller-driven aeroplanes, including their derived versions, with a maximum certificated take-off mass of 55 000 kg and over for which the application for a Type Certificate was submitted on or after 31 December 2017;
- b) all subsonic jet aeroplanes, including their derived versions, with a maximum certificated take-off mass of less than 55 000 kg for which the application for a Type Certificate was submitted on or after 31 December 2020;
- c) all propeller-driven aeroplanes, including their derived versions, with a maximum certificated take-off mass of over 8 618 kg and less than 55 000 kg for which the application for a Type Certificate was submitted on or after 31 December 2020; and
- d) all subsonic jet aeroplanes and all propeller-driven aeroplanes certificated originally as satisfying Annex 16, Volume I, Chapter 3, Chapter 4 or Chapter 5, for which recertification to Chapter 14 is requested.

*Note.— Guidance material on applications for recertification is provided in the Environmental Technical Manual (Doc 9501), Volume I — Procedures for Noise Certification of Aircraft.*

14.1.2 Notwithstanding 14.1.1, it may be recognized by a Contracting State that the following situations for jet aeroplanes and propeller-driven aeroplanes over 8 618 kg maximum certificated take-off mass on its registry do not require demonstration of compliance with the provisions of the Standards of Annex 16, Volume I:

---

1. With no stopway or clearway.

- a) gear down flight with one or more retractable landing gear down during the entire flight;
- b) spare engine and nacelle carriage external to the skin of the aeroplane (and return of the pylon or other external mount); and
- c) time-limited engine and/or nacelle changes, where the change in type design specifies that the aeroplane may not be operated for a period of more than 90 days unless compliance with the provisions of Annex 16, Volume I, is shown for that change in type design. This applies only to changes resulting from a required maintenance action.

## 14.2 Noise measurements

### 14.2.1 Noise evaluation measure

The noise evaluation measure shall be the effective perceived noise level in EPNdB as described in Appendix 2.

## 14.3 Reference noise measurement points

14.3.1 An aeroplane, when tested in accordance with these Standards, shall not exceed the maximum noise level specified in 14.4 of the noise measured at the points specified in Chapter 3, 3.3.1 a), b) and c).

### 14.3.2 Test noise measurement points

The provisions of Chapter 3, 3.3.2, relating to test noise measurement points shall apply.

## 14.4 Maximum noise levels

14.4.1 The maximum noise levels, when determined in accordance with the noise evaluation method of Appendix 2, shall not exceed the following:

### 14.4.1.1 *At the lateral full-power reference noise measurement point*

103 EPNdB for aeroplanes with maximum certificated take-off mass, at which the noise certification is requested, of 400 000 kg and over, decreasing linearly with the logarithm of the mass down to 94 EPNdB at 35 000 kg, after which the limit is constant to 8 618 kg, where it decreases linearly with the logarithm of the mass down to 88.6 EPNdB at 2 000 kg, after which the limit is constant.

### 14.4.1.2 *At the flyover reference noise measurement point*

#### a) *Aeroplanes with two engines or less*

101 EPNdB for aeroplanes with maximum certificated take-off mass, at which the noise certification is requested, of 385 000 kg and over, decreasing linearly with the logarithm of the mass at the rate of 4 EPNdB per halving of mass down to 89 EPNdB, after which the limit is constant to 8 618 kg, where it decreases linearly with the logarithm of the mass at a rate of 4 EPNdB per halving of mass down to 2 000 kg, after which the limit is constant.

b) *Aeroplanes with three engines*

As a) but with 104 EPNdB for aeroplanes with maximum certificated take-off mass of 385 000 kg and over.

c) *Aeroplanes with four engines or more*

As a) but with 106 EPNdB for aeroplanes with maximum certificated take-off mass of 385 000 kg and over.

14.4.1.3 *At the approach reference noise measurement point*

105 EPNdB for aeroplanes with maximum certificated take-off mass, at which the noise certification is requested, of 280 000 kg and over, decreasing linearly with the logarithm of the mass down to 98 EPNdB at 35 000 kg, after which the limit is constant to 8 618 kg, where it decreases linearly with the logarithm of the mass down to 93.1 EPNdB at 2 000 kg, after which the limit is constant.

14.4.1.4 The sum of the differences at all three measurement points between the maximum noise levels and the maximum permitted noise levels specified in 14.4.1.1, 14.4.1.2 and 14.4.1.3, shall not be less than 17 EPNdB.

14.4.1.5 The maximum noise level at each of the three measurement points shall not be less than 1 EPNdB below the corresponding maximum permitted noise level specified in 14.4.1.1, 14.4.1.2 and 14.4.1.3.

*Note.*— See Attachment A for equations for the calculation of maximum permitted noise levels as a function of take-off mass.

## 14.5 Noise certification reference procedures

The noise certification reference procedures shall be as specified in Chapter 3, 3.6.

## 14.6 Test procedures

The test procedures shall be as specified in Chapter 3, 3.7.

## 14.7 Recertification

For aeroplanes specified in 14.1.1 d), recertification shall be granted on the basis that the evidence used to determine compliance with Chapter 14 is as satisfactory as the evidence associated with aeroplanes specified in 14.1.1 a), b) and c).



### **PART III. NOISE MEASUREMENT FOR MONITORING PURPOSES**

*Note.— The following Recommendation has been developed to assist States that measure noise for monitoring purposes, until such time as agreement on a single method can be reached.*

**Recommendation.—** *Where the measurement of aircraft noise is made for monitoring purposes, the method of Appendix 5 should be used.*

*Note.— These purposes are described as including: monitoring compliance with and checking the effectiveness of such noise abatement requirements as may have been established for aircraft in flight or on the ground. An indication of the degree of correlation between values obtained by the method used for measuring noise for aircraft design purposes and the method(s) used for monitoring purposes would be necessary.*

---



## PART IV. ASSESSMENT OF AIRPORT NOISE

*Note.— The following Recommendations have been developed for the purpose of promoting international communication between States that have adopted a variety of methods of assessing noise for land-use planning purposes.*

1. **Recommendation.**— *Where international comparison of noise assessment around airports is undertaken, the methodology described in Recommended Method for Computing Noise Contours Around Airports (Doc 9911) should be used.*

2. **Recommendation.**— *Contracting States that have not yet adopted, or are considering changing a national noise assessment methodology, should use the methodology described in Recommended Method for Computing Noise Contours Around Airports (Doc 9911).*

---





## PART V. BALANCED APPROACH TO NOISE MANAGEMENT

*Note.— Provisions in Part II of this Annex are aimed at noise certification which characterizes the maximum noise emitted by the aircraft. However, noise abatement procedures approved by national authorities and included in operations manuals allow a reduction of noise during aircraft operations.*

1. The balanced approach to noise management consists of identifying the noise problem at an airport and then analysing the various measures available to reduce noise through the exploration of four principal elements, namely reduction at source (addressed in Part II of this Annex), land-use planning and management, noise abatement operational procedures and operating restrictions, with the goal of addressing the noise problem in the most cost-effective manner. All the elements of the balanced approach are addressed in the *Guidance on the Balanced Approach to Aircraft Noise Management* (Doc 9829).

2. Aircraft operating procedures for noise abatement shall not be introduced unless the regulatory authority, based on appropriate studies and consultation, determines that a noise problem exists.

3. Aircraft operating procedures for noise abatement shall be developed in consultation with operators that use the aerodrome concerned.

4. **Recommendation.**— *The factors to be taken into consideration in the development of appropriate aircraft operating procedures for noise abatement should include the following:*

- a) *the nature and extent of the noise problem including:*
  - 1) *the location of noise-sensitive areas; and*
  - 2) *critical hours;*
- b) *the types of aircraft affected, including aircraft mass, aerodrome elevation, temperature considerations;*
- c) *the types of procedures likely to be most effective;*
- d) *obstacle clearances (PANS-OPS (Doc 8168), Volumes I and II); and*
- e) *human performance in the application of the operating procedures.*

*Note 1.— See Annex 6, Part I, Chapter 4, for aeroplane noise abatement operating procedures.*

*Note 2.— Guidance material on human performance can be found in the Human Factors Training Manual (Doc 9683).*

5. **Recommendation.**— *Although in most countries, land-use planning and management are the responsibility of national and/or local planning authorities rather than aviation authorities, ICAO has developed guidance material which should be used to assist planning authorities in taking appropriate measures to ensure compatible land-use management around airports to the benefit of both the airport and the surrounding communities (Airport Planning Manual, Part 2 — Land Use and Environmental Control (Doc 9184)).*



# APPENDIX 1. EVALUATION METHOD FOR NOISE CERTIFICATION OF SUBSONIC JET AEROPLANES — Application for Type Certificate submitted before 6 October 1977

*Note 1.— See Part II, Chapter 2.*

*Note 2.— The procedures in this appendix also apply to certain aircraft types covered in Chapters 5 and 12.*

## 1. INTRODUCTION

*Note 1.— This noise evaluation method includes:*

- a) noise certification test and measurement conditions;*
- b) measurement of aeroplane noise received on the ground;*
- c) calculation of effective perceived noise level from measured noise data; and*
- d) reporting of data to the certificating authority and correcting measured data.*

*Note 2.— The instructions and procedures given in the method are clearly delineated to ensure uniformity during compliance tests, and to permit comparison between tests of various types of aeroplanes, conducted in various geographical locations. It applies only to aeroplanes within the applicability clauses of Part II, Chapter 2.*

*Note 3.— A complete list of symbols and units, the mathematical formulation of perceived noisiness, a procedure for determining atmospheric attenuation of sound, and detailed procedures for correcting noise levels from non-reference to reference conditions are included in Sections 6 to 9 of this appendix.*

## 2. NOISE CERTIFICATION TEST AND MEASUREMENT CONDITIONS

### 2.1 General

This section prescribes the conditions under which noise certification tests shall be conducted and the measurement procedures that shall be used.

*Note.— Many applications for a noise certificate involve only minor changes to the aeroplane type design. The resultant changes in noise can often be established reliably without the necessity of resorting to a complete test as outlined in this appendix. For this reason certificating authorities are encouraged to permit the use of appropriate “equivalent procedures”. Also, there are equivalent procedures that may be used in full certification tests, in the interest of reducing costs and providing reliable results. Guidance material on the use of equivalent procedures in the noise certification of subsonic jet aeroplanes is provided in the Environmental Technical Manual (Doc 9501), Volume I — Procedures for the Noise Certification of Aircraft.*

## 2.2 General test conditions

2.2.1 Tests to show compliance with established noise certification levels shall consist of a series of take-offs and landings during which measurements shall be taken at the measuring points specified by the certifying authority. These points are typically:

- a) the flyover noise measurement point;<sup>1</sup>
- b) the approach noise measurement point; and
- c) the lateral noise measurement point(s),<sup>2</sup>

which for noise certification purposes are specified in Part II, Chapter 2, 2.3. To ensure that the maximum subjective noise level along the lateral is obtained, a sufficient number of lateral stations shall be used. To establish whether any asymmetry exists in the noise field at least one measuring station shall be located along the alternative lateral. On each test take-off simultaneous measurements shall be made at the lateral measuring points on both sides of the runway and also at the take-off flyover measuring point.

2.2.2 Locations for measuring noise from an aeroplane in flight shall be surrounded by relatively flat terrain having no excessive sound absorption characteristics such as might be caused by thick, matted or tall grass, shrubs or wooded areas. No obstructions which significantly influence the sound field from the aeroplane shall exist within a conical space above the measurement position, the cone being defined by an axis normal to the ground and by a half-angle 75° from this axis. If the height of the ground at any measuring point differs from that of the nearest point on the runway by more than 6 m (20 ft), corrections shall be made.

*Note.— Those people carrying out the measurements could themselves constitute such obstructions.*

2.2.3 The tests shall be carried out under the following atmospheric conditions:

- a) no precipitation;
- b) relative humidity not higher than 90 per cent or lower than 30 per cent;
- c) ambient temperature not above 30°C and not below 2°C at 10 m (33 ft) above ground;
- d) average wind speed not exceeding 5.1 m/s (10 kt) and average crosswind component not exceeding 2.6 m/s (5 kt) at 10 m (33 ft) above ground. A 30-second averaging period spanning the 10 dB-down time interval is recommended; and

*Note.— The noise certification test windows for wind speed expressed in m/s are the result of converting historically used values expressed in knots using a conversion factor consistent with Annex 5, Chapter 3, Table 3-3, and rounded to 0.1 m/s. The values as given here, expressed in either unit, are considered equivalent for establishing adherence to the wind speed test windows for noise certification purposes.*

- e) no temperature inversion or anomalous wind conditions that would significantly affect the noise level of the aeroplane when the noise is recorded at the measuring points specified by the certifying authority.

---

1. Sometimes referred to as the take-off noise measurement point.

2. Sometimes referred to as the sideline measurement point(s).

### 2.3 Aeroplane testing procedures

2.3.1 The test procedures shall be acceptable to the airworthiness and noise certificating authorities of the State issuing the certificate.

2.3.2 The aeroplane testing procedures and noise measurements shall be conducted and processed in an approved manner to yield the noise evaluation measure designated as effective perceived noise level, EPNL, in units of EPNdB, as described in Section 4 of this appendix.

2.3.3 The aeroplane height and lateral position relative to the extended centre line of the runway shall be determined by a method independent of normal flight instrumentation, such as radar tracking, theodolite triangulation or photographic scaling techniques, to be approved by the certificating authority.

2.3.4 The aeroplane position along the flight path shall be related to the noise recorded at the noise measurement locations by means of synchronizing signals. The position of the aeroplane shall be recorded relative to the runway from a point at least 7.4 km (4 NM) from threshold during the approach and at least 11 km (6 NM) from the start of roll during take-off.

2.3.5 If the take-off test is conducted at a mass different from the maximum take-off mass at which noise certification is requested, the necessary EPNL correction shall not exceed 2 EPNdB. If the approach test is conducted at a mass different from the maximum landing mass at which noise certification is requested, the EPNL correction shall not exceed 1 EPNdB. Data approved by the certificating authority shall be used to determine the variation of EPNL with mass for both take-off and approach test conditions.

### 2.4 Measurements

2.4.1 Position and performance data required to make the corrections referred to in Section 5 of this appendix shall be automatically recorded at an approved sampling rate. The position of the aeroplane shall be recorded relative to the runway from a point at least 7.4 km (4 NM) from threshold to touchdown during the approach and at least 11 km (6 NM) from the start of roll during the take-off. Measuring equipment shall be approved by the certificating authority.

2.4.2 Position and performance data shall be corrected by the methods outlined in Section 5 of this appendix to the meteorological reference conditions specified in 5.3 a).

2.4.3 Acoustic data shall be corrected by the methods outlined in Section 5 of this appendix to the meteorological reference conditions specified in 5.3 a) 1), 2) and 3). Acoustic data corrections shall also be made for variations of the test minimum distance from the reference minimum distance between the aeroplane's approach path and the approach measuring point, a take-off path vertically above the flyover measuring point and for differences of more than 6 m (20 ft) in elevation of measuring locations relative to the elevation of the nearest point of the runway.

2.4.4 The aerodrome tower or another facility shall be approved for use as the central location at which measurements of atmospheric parameters are representative of those conditions existing over the geographical area in which aeroplane noise measurements are made. However, the surface wind velocity and ambient air temperature shall be measured near the microphone position at the approach, sideline, and take-off measurement locations, and the tests shall not be acceptable unless the conditions conform to Section 2 of this appendix.

## 3. MEASUREMENT OF AEROPLANE NOISE RECEIVED ON THE GROUND

### 3.1 General

3.1.1 The measurements shall provide the data for determining one-third octave band noise produced by aeroplanes during flight, at any required observation stations, as a function of time.

3.1.2 Methods for determination of the distance from the observation stations to the aeroplane shall include theodolite triangulation techniques, scaling aeroplane dimensions on photographs made as the aeroplane flies directly over the measurement points, radar altimeters, and radar tracking systems. The method used shall be approved by the certificating authority.

3.1.3 Sound pressure level data for noise evaluation purposes shall be obtained with approved acoustical equipment and measurement practices that conform to the specifications given hereunder (in 3.2 to 3.4).

### 3.2 Measurement system

The acoustical measurement system shall consist of approved equipment equivalent to the following:

- a) a microphone system with frequency response compatible with measurement and analysis system accuracy as stated in 3.3;
- b) tripods or similar microphone mountings that minimize interference with the sound being measured;
- c) recording and reproducing equipment characteristics, frequency response, and dynamic range compatible with the response and accuracy requirements of 3.3;
- d) acoustic calibrators using sine wave or broadband noise of known sound pressure level. If broadband noise is used, the signal shall be described in terms of its average and maximum root-mean-square (rms) value for non-overload signal level;
- e) analysis equipment with the response and accuracy requirements of 3.4.

### 3.3 Sensing, recording and reproducing equipment

3.3.1 The sound produced by the aeroplane shall be recorded in such a way that the complete information, time history included, is retained. A magnetic tape recorder is acceptable.

3.3.2 The characteristics of the system shall comply with the recommendations given in International Electrotechnical Commission (IEC) Publication No. 179<sup>3</sup> with regard to the sections concerning microphone and amplifier characteristics.

*Note.— The text and specifications of IEC Publication No. 179<sup>3</sup> entitled “Precision Sound Level Meters” are incorporated by reference into this appendix and are made a part hereof.<sup>4</sup>*

3.3.3 The response of the complete system to a sensibly plane progressive sinusoidal wave of constant amplitude shall lie within the tolerance limits specified in IEC Publication No. 179,<sup>3</sup> over the frequency range 45 to 11 200 Hz.

3.3.4 If limitations of the dynamic range of the equipment make it necessary, high frequency pre-emphasis shall be added to the recording channel with the converse de-emphasis on playback. The pre-emphasis shall be so applied that the instantaneous recorded sound pressure level between 800 and 11 200 Hz of the maximum measured noise signal does not vary more than 20 dB between the levels of the maximum and minimum one-third octave bands.

3.3.5 The equipment shall be acoustically calibrated using facilities for acoustic free-field calibration and electronically calibrated as stated in 3.4.

---

3. As amended.

4. This publication was first issued in 1965 by the Central Office of the International Electrotechnical Commission, 3 rue de Varembé, Geneva, Switzerland.

3.3.6 A windscreen shall be employed with the microphone during all measurements of aeroplane noise when the wind speed is in excess of 3 m/s (6 kt). Corrections for any insertion loss produced by the windscreen, as a function of frequency, shall be applied to the measured data and the corrections applied shall be reported.

### 3.4 Analysis equipment

3.4.1 A frequency analysis of the acoustical signal shall be performed in a manner equivalent to using one-third octave filters complying with the recommendations given in IEC Publication No. 225.<sup>5</sup>

*Note.*— *The text and specifications of IEC Publication No. 225<sup>5</sup> entitled “Octave, Half-Octave and Third-Octave Band Filters Intended for the Analysis of Sounds and Vibrations” are incorporated by reference into this appendix and are made a part hereof.*<sup>6</sup>

3.4.2 A set of 24 consecutive one-third octave filters or its equivalent shall be used. The first filter of the set shall be centred at a geometric mean frequency of 50 Hz and the last shall be centred at a geometric mean frequency of 10 kHz.

3.4.3 The analyser indicating device shall be analogue, digital, or a combination of both. The preferred sequence of signal processing shall be:

- a) squaring the one-third octave filter outputs;
- b) averaging or integrating; and
- c) linear to logarithmic conversion.

The indicating device shall have a minimum crest factor capacity of 3 and shall measure, within a tolerance of  $\pm 1.0$  dB, the true root-mean-square (rms) level of the signal in each of the 24 one-third octave bands. If other than a true rms device is utilized, it shall be calibrated for nonsinusoidal signals and time varying levels. The calibration shall provide means for converting the output levels to true rms values.

3.4.4 The dynamic response of the analyser to input signals of both full-scale and 20 dB less than full-scale amplitude shall conform to the following two requirements:

- a) the maximum output value shall read  $4 \text{ dB} \pm 1 \text{ dB}$  less than the value obtained for a steady-state signal of the same frequency and amplitude when a sinusoidal pulse of 0.5 s duration at the centre frequency of each one-third octave band is applied to the input;
- b) the maximum output value shall exceed the final steady-state value by  $0.5 \pm 0.5 \text{ dB}$  when a steady-state sinusoidal signal at the geometrical mean frequency of each one-third octave band is suddenly applied to the analyser input and held constant.

3.4.5 A single value of the rms level shall be provided every  $0.5 \pm 0.01$  s for each of the 24 one-third octave bands. The levels from all of the 24 one-third octave bands shall be obtained within a 50 ms period. No more than 5 ms of data from any 0.5 s period shall be excluded from the measurement.

3.4.6 The amplitude resolution of the analyser shall be 0.50 dB or less.

---

5. As amended.

6. This publication was first issued in 1966 by the Central Office of the International Electrotechnical Commission, 3 rue de Varembe, Geneva, Switzerland.

3.4.7 Each output level from the analyser shall be accurate within  $\pm 1.0$  dB with respect to the input signal, after all systematic errors have been eliminated. The total systematic errors for each of the output levels shall not exceed  $\pm 3$  dB. For contiguous filter systems, the systematic correction between adjacent one-third octave channels shall not exceed 4 dB.

3.4.8 The dynamic range capability of the analyser for display of a single aeroplane noise event shall be at least 45 dB in terms of the difference between full-scale output level and the maximum noise level of the analyser equipment.

3.4.9 The complete electronic system shall be subjected to a frequency and amplitude electrical calibration by the use of sinusoidal or broadband signals at frequencies covering the range of 45 to 11 200 Hz, and of known amplitudes covering the range of signal levels furnished by the microphone. If broadband signals are used, they shall be described in terms of their average and maximum rms values for a non-overload signal level.

### 3.5 Noise measurement procedures

3.5.1 The microphones shall be oriented in a known direction so that the maximum sound received arrives as nearly as reasonable in the direction for which the microphones are calibrated. The microphones shall be placed so that their sensing elements are approximately 1.2 m (4 ft) above ground.

3.5.2 Immediately prior to and after each test, a recorded acoustic calibration of the system shall be made in the field with an acoustic calibrator for the two purposes of checking system sensitivity and providing an acoustic reference level for the analysis of the sound level data.

3.5.3 For the purpose of minimizing equipment or operator error, field calibrations shall be supplemented whenever practicable with the use of an insert voltage device to place a known signal at the input of the microphone, just prior to and after recording aeroplane noise data.

3.5.4 Background noise, including ambient noise and electrical noise of the measurement systems, shall be recorded and determined in the test area with the system gain set at levels which will be used for aeroplane noise measurements. If aeroplane sound pressure levels do not exceed background sound pressure levels by at least 10 dB in any significant one-third octave band, approved corrections for the contribution of background sound pressure level to the observed sound pressure level shall be applied.

## 4. CALCULATION OF EFFECTIVE PERCEIVED NOISE LEVEL FROM MEASURED NOISE DATA

### 4.1 General

4.1.1 The basic element in the noise certification criteria shall be the noise evaluation measure designated effective perceived noise level, EPNL, in units of EPNdB, which is a single number evaluator of the subjective effects of aeroplane noise on human beings. Simply stated, EPNL shall consist of instantaneous perceived noise level, PNL, corrected for spectral irregularities (the correction, called “tone correction factor”, is made for the maximum tone only at each increment of time) and for duration.

4.1.2 Three basic physical properties of sound pressure shall be measured: level, frequency distribution, and time variation. More specifically, the instantaneous sound pressure level in each of 24 one-third octave bands of the noise shall be required for each one-half second increment of time during the aeroplane flyover.

4.1.3 The calculation procedure which utilizes physical measurements of noise to derive the EPNL evaluation measure of subjective response shall consist of the following five steps:



- a) the 24 one-third octave bands of sound pressure level are converted to perceived noisiness by means of a noy table.<sup>7</sup> The noy values are combined and then converted to instantaneous perceived noise levels, PNL(*k*);
- b) a tone correction factor, *C*(*k*), is calculated for each spectrum to account for the subjective response to the presence of spectral irregularities;
- c) the tone correction factor is added to the perceived noise level to obtain tone corrected perceived noise levels, PNL*T*(*k*), at each one-half second increment of time:

$$\text{PNLT}(k) = \text{PNL}(k) + C(k)$$

The instantaneous values of tone corrected perceived noise level are derived and the maximum value, PNL*T**M*, is determined;

- d) a duration correction factor, *D*, is computed by integration under the curve of tone corrected perceived noise level versus time;
- e) effective perceived noise level, EPNL, is determined by the algebraic sum of the maximum tone corrected perceived noise level and the duration correction factor:

$$\text{EPNL} = \text{PNLTM} + D.$$

#### 4.2 Perceived noise level

Instantaneous perceived noise levels, PNL(*k*), shall be calculated from instantaneous one-third octave band sound pressure levels, SPL(*i*,*k*), as follows:

*Step 1.* Convert each one-third octave band, SPL(*i*,*k*), from 50 to 10 000 Hz, to perceived noisiness, *n*(*i*,*k*), by reference to Table A1-1, or to the mathematical formulation of the noy table given in Section 7.

*Step 2.* Combine the perceived noisiness values, *n*(*i*,*k*), found in Step 1 by the following formula:

$$\begin{aligned} N(k) &= n(k) + 0.15 \left\{ \left[ \sum_{i=1}^{24} n(i, k) \right] - n(k) \right\} \\ &= 0.85 n(k) + 0.15 \sum_{i=1}^{24} n(i, k) \end{aligned}$$

where *n*(*k*) is the largest of the 24 values of *n*(*i*,*k*), and *N*(*k*) is the total perceived noisiness.

*Step 3.* Convert the total perceived noisiness, *N*(*k*), into perceived noise level, PNL(*k*), by the following formula:

$$\text{PNL}(k) = 40.0 + \frac{10}{\log 2} \log N(k)$$

which is plotted in Figure A1-1. PNL(*k*) may also be obtained by choosing *N*(*k*) in the 1 000 Hz column of Table A1-1 and then reading the corresponding value of SPL(*i*,*k*) which, at 1 000 Hz, equals PNL(*k*).

7. See Table A1-1.

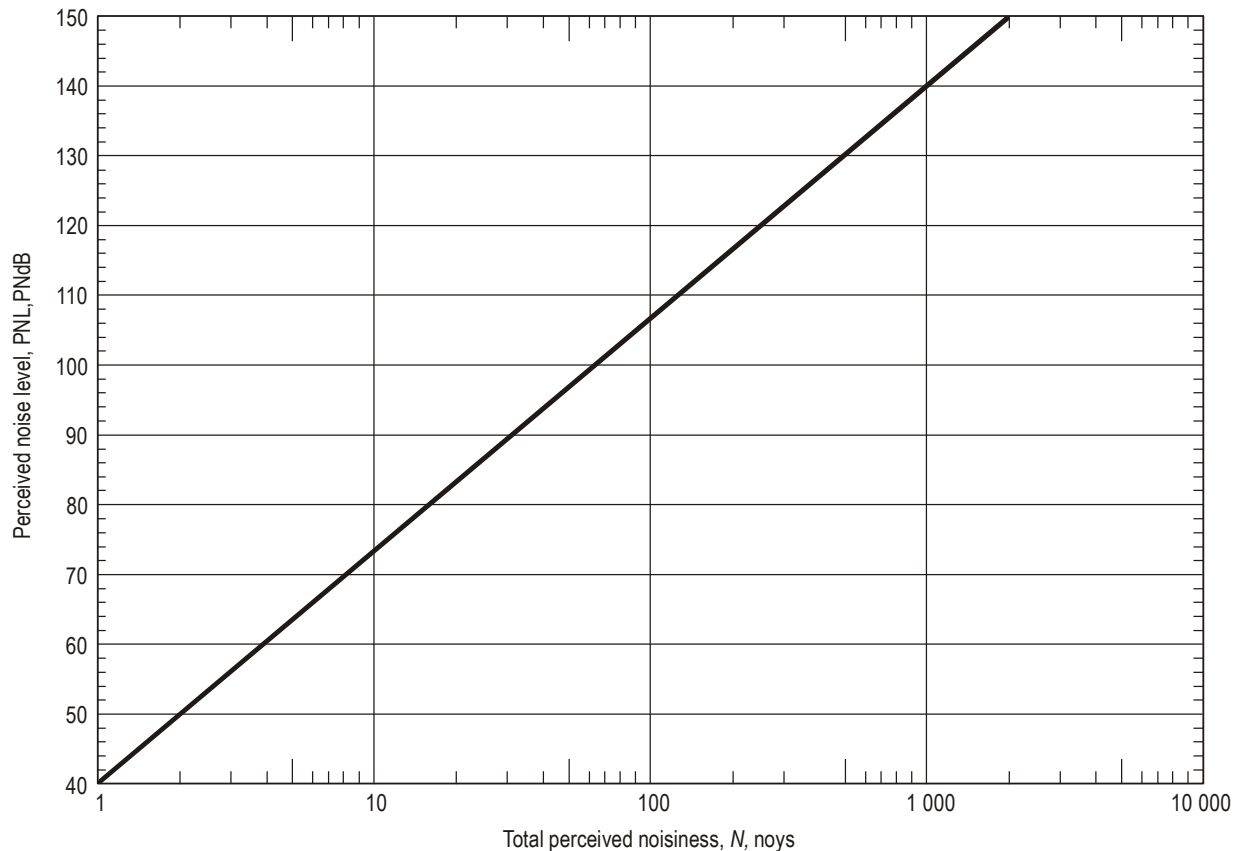

**Figure A1-1. Perceived noise level as a function of total perceived noisiness**

### 4.3 Correction for spectral irregularities

Noise having pronounced spectral irregularities (for example, the maximum discrete frequency components or tones) shall be adjusted by the correction factor,  $C(k)$ , calculated as follows:

*Step 1.* Starting with the corrected sound pressure level in the 80 Hz one-third octave band (band number 3), calculate the changes in sound pressure level (or “slopes”) in the remainder of the one-third octave bands as follows:

- $s(3,k) = \text{no value}$
- $s(4,k) = \text{SPL}(4,k) - \text{SPL}(3,k)$
- 
- 
- 
- $s(i,k) = \text{SPL}(i,k) - \text{SPL}[(i-1),k]$
- 
- 
- 
- $s(24,k) = \text{SPL}(24,k) - \text{SPL}(23,k)$

*Step 2.* Encircle the value of the slope,  $s(i,k)$ , where the absolute value of the change in slope is greater than five; that is, where:

$$|\Delta s(i,k)| = |s(i,k) - s[(i-1),k]| > 5$$

Table A1-1. Noys as a function of sound pressure level (29<SPL<89)

SPL (dB)	One-third octave band centre frequencies (Hz)																																
	50	63	80	100	125	160	200	250	315	400	500	630	800	1000	1250	1600	2000	2500	3150	4000	5000	6300	8000	10000									
29																			1.00	1.00													
30																			1.00	1.07	1.07	1.00											
31																			1.07	1.15	1.15	1.07											
32																		1.00	1.15	1.23	1.23	1.15	1.07										
33																		1.07	1.23	1.32	1.32	1.23	1.15										
34																1.00	1.15	1.32	1.41	1.41	1.32	1.15	1.23										
35																	1.07	1.23	1.41	1.51	1.51	1.41	1.32										
36																	1.15	1.32	1.51	1.62	1.62	1.51	1.41										
37																	1.23	1.41	1.62	1.74	1.74	1.62	1.51										
38															1.00	1.32	1.51	1.74	1.86	1.86	1.74	1.62	1.51	1.00									
39															1.07	1.41	1.62	1.86	1.99	1.99	1.86	1.74	1.62	1.10									
40										1.00	1.00	1.00	1.00	1.00	1.15	1.51	1.74	1.99	2.14	2.14	1.99	1.86	1.74	1.21									
41										1.07	1.07	1.07	1.07	1.07	1.23	1.62	1.86	2.14	2.29	2.29	2.14	1.99	1.86	1.34									
42										1.00	1.15	1.15	1.15	1.15	1.32	1.74	1.99	2.29	2.45	2.45	2.29	2.14	1.63	1.10									
43										1.07	1.23	1.23	1.23	1.23	1.41	1.86	2.14	2.45	2.63	2.63	2.45	2.29	1.79	1.21									
44								1.00	1.15	1.32	1.32	1.32	1.32	1.32	1.52	1.99	2.29	2.63	2.81	2.81	2.63	2.45	1.99	1.34									
45										1.08	1.24	1.41	1.41	1.41	1.62	2.14	2.45	2.81	3.02	3.02	2.81	2.63	2.14	1.48									
46										1.00	1.16	1.33	1.52	1.52	1.74	2.29	2.63	3.02	3.23	3.23	3.02	2.81	2.29	1.63									
47										1.08	1.25	1.42	1.62	1.62	1.87	2.45	2.81	3.23	3.46	3.46	3.23	3.02	2.45	1.79									
48										1.00	1.17	1.34	1.53	1.74	1.74	2.00	2.63	3.02	3.46	3.71	3.71	3.46	3.23	2.63	1.98								
49										1.08	1.26	1.45	1.64	1.87	1.87	2.14	2.81	3.23	3.71	3.97	3.97	3.71	3.46	2.81	2.15								
50											1.17	1.36	1.56	1.76	2.00	2.00	2.30	3.02	3.46	3.97	4.26	4.26	3.97	3.71	3.02	2.40							
51											1.00	1.26	1.47	1.68	1.89	2.14	2.14	2.46	3.23	3.71	4.26	4.56	4.26	3.97	3.23	2.63							
52											1.08	1.36	1.58	1.80	2.03	2.30	2.30	2.64	3.46	3.97	4.56	4.89	4.56	4.26	3.46	2.81							
53											1.00	1.18	1.47	1.71	1.94	2.17	2.46	2.46	2.83	3.71	4.26	4.89	5.24	4.89	4.56	3.71	3.02						
54											1.09	1.28	1.58	1.85	2.09	2.33	2.64	2.64	3.03	3.97	4.56	5.24	5.61	5.24	4.89	3.97	3.23						
55											1.18	1.38	1.71	2.00	2.25	2.50	2.83	2.83	3.25	4.26	4.89	5.61	6.01	5.61	5.24	4.26	3.46						
56											1.00	1.29	1.50	1.85	2.15	2.42	2.69	3.03	3.03	3.48	4.56	5.24	6.01	6.44	6.01	5.61	4.56	3.71					
57											1.09	1.40	1.63	2.00	2.33	2.61	2.88	3.25	3.25	3.73	4.89	5.61	6.44	6.90	6.44	6.01	4.89	3.97					
58											1.18	1.53	1.77	2.15	2.51	2.81	3.10	3.48	3.48	3.48	4.00	5.24	6.01	6.90	7.39	6.90	6.44	5.24	4.26				
59											1.29	1.66	1.92	2.33	2.71	3.03	3.32	3.73	3.73	3.73	4.29	5.61	6.44	7.39	7.92	7.39	6.90	5.61	4.56				
60											1.00	1.40	1.81	2.08	2.51	2.93	3.26	3.57	4.00	4.00	4.59	6.01	6.90	7.92	8.49	7.92	7.39	6.01	4.89				
61											1.10	1.53	1.97	2.26	2.71	3.16	3.51	3.83	4.29	4.29	4.29	4.29	4.29	4.92	6.44	7.39	8.49	9.09	8.49	6.44	5.24		
62											1.21	1.66	2.15	2.45	2.93	3.41	3.78	4.11	4.59	4.59	4.59	5.28	6.90	7.92	9.09	9.74	9.09	8.49	6.90	5.61			
63											1.32	1.81	2.34	2.65	3.16	3.69	4.06	4.41	4.92	4.92	4.92	5.66	7.39	8.49	9.74	10.4	10.4	9.74	9.09	7.39	6.01		
64											1.00	1.45	1.97	2.54	2.88	3.41	3.98	4.38	4.73	5.28	5.28	6.06	7.92	9.09	10.4	11.2	11.2	10.4	9.74	7.92	6.44		
65											1.11	1.60	2.15	2.77	3.12	3.69	4.30	4.71	5.08	5.66	5.66	6.50	8.49	9.74	11.2	12.0	12.0	11.2	10.4	8.49	6.90		
66											1.22	1.75	2.34	3.01	3.39	3.98	4.64	5.07	5.45	6.06	6.06	6.96	9.09	10.4	12.0	12.8	12.8	12.0	11.2	9.09	7.39		
67											1.35	1.92	2.54	3.28	3.68	4.30	5.01	5.46	5.85	6.50	6.50	7.46	9.74	11.2	12.8	13.8	13.8	12.8	12.0	9.74	7.92		
68											1.49	2.11	2.77	3.57	3.99	4.64	5.41	5.88	6.27	6.96	6.96	8.00	10.4	12.0	13.8	14.7	14.7	13.8	12.8	10.4	8.49		
69											1.65	2.32	3.01	3.88	4.33	5.01	5.84	6.33	6.73	7.46	7.46	8.57	11.2	12.8	14.7	15.8	15.8	14.7	13.8	11.2	9.09		
70											1.82	2.55	3.28	4.23	4.69	5.41	6.31	6.81	7.23	8.00	8.00	9.19	12.0	13.8	15.8	16.9	16.9	15.8	14.7	12.0	9.74		
71											2.02	2.79	3.57	4.60	5.09	5.84	6.81	7.33	7.75	8.57	8.57	9.85	12.8	14.7	16.9	18.1	18.1	16.9	15.8	12.8	10.4		
72											2.23	3.07	3.88	5.01	5.52	6.31	7.36	7.90	8.32	9.19	9.19	10.6	13.8	15.8	18.1	19.4	19.4	18.1	16.9	13.8	11.2		
73											2.46	3.37	4.23	5.45	5.99	6.81	7.94	8.48	8.93	9.85	9.85	11.3	14.7	16.9	19.4	20.8	20.8	19.4	18.1	14.7	12.0		
74											2.72	3.70	4.60	5.94	6.50	7.36	8.57	9.15	9.59	10.6	10.6	12.1	15.8	18.1	20.8	22.3	22.3	20.8	19.4	15.8	12.8		
75											3.01	4.06	5.01	6.46	7.05	7.94	9.19	9.85	10.33	11.3	11.3	13.0	16.9	19.4	22.3	23.9	23.9	22.3	20.8	16.9	13.8		
76											3.32	4.46	5.45	7.03	7.65	8.57	9.85	10.6	11.0	12.1	12.1	13.0	18.1	20.8	23.9	25.6	25.6	23.9	22.3	18.1	14.7		
77											3.67	4.89	5.94	7.66	8.29	9.19	10.6	11.3	11.8	13.0	13.0	14.9	19.4	22.3	25.6	27.4	27.4	25.6	23.9	19.4	15.8		
78											4.06	5.37	6.46	8.33	9.00	9.85	11.3	12.1	12.7	13.9	13.9	16.0	20.8	23.9	27.4	29.4	29.4	27.4	25.6	20.8	16.9		
79											4.49	5.90	7.03	9.07	9.76	10.6	12.1	13.0	13.6	14.9	14.9	17.1	22.3	25.6	29.4	31.5	31.5	29.4	27.4	22.3	18.1		
80											4.96	6.48	7.66	9.85	10.6	11.3	13.0	13.9	14.6	16.0	16.0	18.4	23.9	27.4	31.5	33.7	33.7	31.5	29.4	23.9	19.4		
81											5.48	7.11	8.33	10.6	11.3	12.1	13.9	14.9	15.7	17.1	17.1	19.4	25.6	29.4	33.7	36.1	36.1	33.7	31.5	25.6	20.8		
82											6.06	7.81	9.07	11.3	12.1	13.0	14.9	16.0	16.9	18.4	18.4	21.1	27.4	31.5	36.1	38.7	38.7	36.1	33.7	27.4	22.3		
83											6.70	8.57	9.87	12.1	13.0	13.9	16.0	17.1	18.1	19.7	19.7	22.6	29.4	33.7	38.7	41.5	41.5	38.7	36.1	29.4	23.9		
84											7.41	9.41	10.7	13.0	13.9	14.9	17.1	18.4	19.4	21.1	21.1	24.3	31.5	36.1	41.5	44.4	44.4	41.5	38.7	31.5	25.6		

**Table A1-1 (cont.). Noys as a function of sound pressure level (90<SPL<150)**

SPL (dB)	One-third octave band centre frequencies (Hz)																							
	50	63	80	100	125	160	200	250	315	400	500	630	800	1000	1250	1600	2000	2500	3150	4000	5000	6300	8000	10000
90	13.5	14.9	17.1	19.7	21.1	22.6	26.0	27.9	29.7	32.0	32.0	32.0	32.0	32.0	36.8	47.6	54.7	62.7	67.2	67.2	62.7	58.6	47.6	38.7
91	14.9	16.0	18.4	21.1	22.6	24.3	27.9	29.9	31.8	34.3	34.3	34.3	34.3	34.3	39.4	51.0	58.6	67.2	72.0	72.0	67.2	62.7	51.0	41.5
92	16.0	17.1	19.7	22.6	24.3	26.0	29.9	32.0	34.2	36.8	36.8	36.8	36.8	36.8	42.2	54.7	62.7	72.0	77.2	77.2	72.0	67.2	54.7	44.4
93	17.1	18.4	21.1	24.3	26.0	27.9	32.0	34.3	36.7	39.4	39.4	39.4	39.4	39.4	45.3	58.6	67.2	77.2	82.7	82.7	77.2	72.0	58.6	47.6
94	18.4	19.7	22.6	26.0	27.9	29.9	34.3	36.8	39.4	42.2	42.2	42.2	42.2	42.2	48.5	62.7	72.0	82.7	88.6	88.6	82.7	77.2	62.7	51.0
95	19.7	21.1	24.3	27.9	29.9	32.0	36.8	39.4	42.2	45.3	45.3	45.3	45.3	45.3	52.0	67.2	77.2	88.6	94.9	94.9	88.6	82.7	67.2	54.7
96	21.1	22.6	26.0	29.9	32.0	34.3	39.4	42.2	45.3	48.5	48.5	48.5	48.5	48.5	55.7	72.0	82.7	94.9	102	102	94.9	88.6	72.0	58.6
97	22.6	24.3	27.9	32.0	34.3	36.8	42.2	45.3	48.5	52.0	52.0	52.0	52.0	52.0	59.7	77.2	88.6	102	109	109	102	94.9	77.2	62.7
98	24.3	26.0	29.9	34.3	36.8	39.4	45.3	48.5	52.0	55.7	55.7	55.7	55.7	55.7	64.0	82.7	94.9	109	117	117	109	102	82.7	67.2
99	26.0	27.9	32.0	36.8	39.4	42.2	48.5	52.0	55.7	59.7	59.7	59.7	59.7	59.7	68.6	88.6	102	117	125	125	117	109	88.6	72.0
100	27.9	29.9	34.3	39.4	42.2	45.3	52.0	55.7	59.7	64.0	64.0	64.0	64.0	64.0	73.5	94.9	109	125	134	134	125	117	94.9	77.2
101	29.9	32.0	36.8	42.2	45.3	48.5	55.7	59.7	64.0	68.6	68.6	68.6	68.6	68.6	78.8	102	117	134	144	144	134	125	102	82.7
102	32.0	34.3	39.4	45.3	48.5	52.0	59.7	64.0	68.6	73.5	73.5	73.5	73.5	73.5	84.4	109	125	144	154	154	144	134	109	88.6
103	34.3	36.8	42.2	48.5	52.0	55.7	64.0	68.6	73.5	78.8	78.8	78.8	78.8	78.8	90.5	117	134	154	165	165	154	144	117	94.9
104	36.8	39.4	45.3	52.0	55.7	59.7	68.6	73.5	78.8	84.4	84.4	84.4	84.4	84.4	97.0	125	144	165	177	177	165	154	125	102
105	39.4	42.2	48.5	55.7	59.7	64.0	73.5	78.8	84.4	90.5	90.5	90.5	90.5	90.5	104	134	154	177	189	189	177	165	134	109
106	42.2	45.3	52.0	59.7	64.0	68.6	78.8	84.4	90.5	97.0	97.0	97.0	97.0	97.0	111	144	165	189	203	203	189	177	144	117
107	45.3	48.5	55.7	64.0	68.6	73.5	84.4	90.5	97.0	104	104	104	104	104	119	154	177	203	217	217	203	189	154	125
108	48.5	52.0	59.7	68.6	73.5	78.8	90.5	97.0	104	111	111	111	111	111	128	165	189	217	233	233	217	203	165	134
109	52.0	55.7	64.0	73.5	78.8	84.4	97.0	104	111	119	119	119	119	119	137	177	203	233	249	249	233	217	177	144
110	55.7	59.7	68.6	78.8	84.4	90.5	104	111	119	128	128	128	128	128	147	189	217	249	267	267	249	233	189	154
111	59.7	64.0	73.5	84.4	90.5	97.0	111	119	128	137	137	137	137	137	158	203	233	267	286	286	267	249	203	165
112	64.0	68.6	78.8	90.5	97.0	104	119	128	137	147	147	147	147	147	169	217	249	286	307	307	286	267	217	177
113	68.6	73.5	84.4	97.0	104	111	128	137	147	158	158	158	158	158	181	233	267	307	329	329	307	286	233	189
114	73.5	78.8	90.5	104	111	119	137	147	158	169	169	169	169	169	194	249	286	329	352	352	329	307	249	203
115	78.8	84.4	97.0	111	119	128	147	158	169	181	181	181	181	181	208	267	307	352	377	377	352	329	267	217
116	84.4	90.5	104	119	128	137	158	169	181	194	194	194	194	194	223	286	329	377	404	404	377	352	286	233
117	90.5	97.0	111	128	137	147	169	181	194	208	208	208	208	208	239	307	352	404	433	433	404	377	307	249
118	97.0	104	119	137	147	158	181	194	208	223	223	223	223	223	256	329	377	433	464	464	433	404	329	267
119	104	111	128	147	158	169	194	208	223	239	239	239	239	239	274	352	404	464	497	497	464	433	352	286
120	111	119	137	158	169	181	208	223	239	256	256	256	256	256	294	377	433	497	533	533	497	464	377	307
121	119	128	147	169	181	194	223	239	256	274	274	274	274	274	315	404	464	533	571	571	533	497	404	329
122	128	137	158	181	194	208	239	256	274	294	294	294	294	294	338	433	497	571	611	611	571	533	433	352
123	137	147	169	194	208	223	256	274	294	315	315	315	315	315	362	464	533	611	655	655	611	571	464	377
124	147	158	181	208	223	239	274	294	315	338	338	338	338	338	388	497	571	655	702	702	655	611	497	404
125	158	169	194	223	239	256	294	315	338	362	362	362	362	362	416	533	611	702	752	752	702	655	533	433
126	169	181	208	239	256	274	315	338	362	388	388	388	388	388	446	571	655	752	806	806	752	702	571	464
127	181	194	223	256	274	294	338	362	388	416	416	416	416	416	478	611	702	806	863	863	806	752	611	497
128	194	208	239	274	294	315	362	388	416	446	446	446	446	446	512	655	752	863	925	925	863	806	655	533
129	208	223	256	294	315	338	388	416	446	478	478	478	478	478	549	702	806	925	991	991	925	863	702	571
130	223	239	274	315	338	362	416	446	478	512	512	512	512	512	588	752	863	991	1062	1062	991	925	752	611
131	239	256	294	338	362	388	446	478	512	549	549	549	549	549	630	806	925	1062	1137	1137	1062	991	806	655
132	256	274	315	362	388	416	478	512	549	588	588	588	588	588	676	863	991	1137	1219	1219	1137	1062	863	702
133	274	294	338	388	416	446	512	549	588	630	630	630	630	630	724	925	1062	1219	1306	1306	1219	1137	925	752
134	294	315	362	416	446	478	549	588	630	676	676	676	676	676	776	991	1137	1306	1399	1399	1306	1219	991	806
135	315	338	388	446	478	512	588	630	676	724	724	724	724	724	832	1062	1219	1399	1499	1499	1399	1306	1062	863
136	338	362	416	478	512	549	630	676	724	776	776	776	776	776	891	1137	1306	1499	1606	1606	1499	1399	1137	925
137	362	388	446	512	549	588	676	724	776	832	832	832	832	832	955	1219	1399	1606	1721	1721	1606	1499	1219	991
138	388	416	478	549	588	630	724	776	832	891	891	891	891	891	1024	1306	1499	1721	1844	1844	1721	1606	1306	1062
139	416	446	512	588	630	676	776	832	891	955	955	955	955	955	1098	1399	1606	1844	1975	1975	1844	1721	1399	1137
140	446	478	549	630	676	724	832	891	955	1024	1024	1024	1024	1024	1176	1499	1721	1975			1975	1844	1499	1219
141	478	512	588	676	724	776	891	955	1024	1098	1098	1098	1098	1098	1261	1606	1844				1975	1606	1306	1062
142	512	549	630	724	776	832	955	1024	1098	1176	1176	1176	1176	1176	1351	1721	1975					1721	1399	991
143	549	588	676	776	832	891	1024	1098	1176	1261	1261	1261	1261	1261	1448	1844						1844	1499	1137
144	588	630	724	832	891	955	1098	1176	1261	1351	1351	1351	1351	1351	1552	1975						1975	1721	1399
145	630	676	776	891	955	1024	1176	1261	1351	1448	1448	1448	1448	1448	1664								1844	1499

Step 3.

- a) if the encircled value of the slope  $s(i,k)$  is positive and algebraically greater than the slope  $s[(i-1),k]$ , encircle  $SPL(i,k)$ ;
- b) if the encircled value of the slope  $s(i,k)$  is zero or negative and the slope  $s[(i-1),k]$  is positive, encircle  $SPL[(i-1),k]$ ; and
- c) for all other cases, no sound pressure level value is to be encircled.

Step 4. Omit all  $SPL(i,k)$  encircled in Step 3 and compute new adjusted sound pressure levels,  $SPL'(i,k)$ , as follows:

- a) for non-encircled sound pressure levels, let the new sound pressure levels equal the original sound pressure levels,  $SPL'(i,k) = SPL(i,k)$ ;
- b) for encircled sound pressure levels in bands 1 to 23 inclusive, let the new sound pressure level equal the arithmetic average of the preceding and following sound pressure levels:

$$SPL'(i,k) = (1/2) \{SPL[(i-1),k] + SPL[(i+1),k]\}$$

- c) if the sound pressure level in the highest frequency band ( $i = 24$ ) is encircled, let the new sound pressure level in that band equal:

$$SPL'(24,k) = SPL(23,k) + s(23,k)$$

Step 5. Recompute new slopes  $s'(i,k)$ , including one for an imaginary 25th band, as follows:

$$s'(3,k) = s'(4,k)$$

$$s'(4,k) = SPL'(4,k) - SPL'(3,k)$$

•

•

•

$$s'(i,k) = SPL'(i,k) - SPL'[(i-1),k]$$

•

•

•

$$s'(24,k) = SPL'(24,k) - SPL'(23,k)$$

$$s'(25,k) = s'(24,k)$$

Step 6. For  $i$  from 3 to 23, compute the arithmetic average of the three adjacent slopes as follows:

$$\bar{s}(i,k) = (1/3) \{s'(i,k) + s'[(i+1),k] + s'[(i+2),k]\}$$

Step 7. Compute final one-third octave-band background sound pressure levels,  $SPL''(i,k)$ , by beginning with band number 3 and proceeding to band number 24 as follows:

$$SPL''(3,k) = SPL(3,k)$$

$$SPL''(4,k) = SPL''(3,k) + \bar{s}(3,k)$$

•

•

•

$$SPL''(i,k) = SPL''[(i-1),k] + \bar{s}(i-1,k)$$

•

•

•

$$\text{SPL}''(24,k) = \text{SPL}''(23,k) + \bar{s}(23,k)$$

Step 8. Calculate the differences,  $F(i,k)$ , between the original sound pressure level and the final background sound pressure level as follows:

$$F(i,k) = \text{SPL}(i,k) - \text{SPL}''(i,k)$$

and note only values equal to or greater than three.

Step 9. For each of the relevant one-third octave bands (3 to 24), determine tone correction factors from the sound pressure level differences,  $F(i,k)$ , and Table A1-2.

Step 10. Designate the largest of the tone correction factors, determined in Step 9, as  $C(k)$ . An example of the tone correction procedure is given in Table A1-3.

Tone corrected perceived noise levels  $\text{PNLT}(k)$  shall be determined by adding the  $C(k)$  values to corresponding  $\text{PNLT}(k)$  values, that is:

$$\text{PNLT}(k) = \text{PNL}(k) + C(k)$$

For any  $i$ -th one-third octave band, at any  $k$ -th increment of time, for which the tone correction factor is suspected to result from something other than (or in addition to) an actual tone (or any spectral irregularity other than aeroplane noise), an additional analysis shall be made using a filter with a bandwidth narrower than one-third of an octave. If the narrow band analysis corroborates these suspicions, then a revised value for the background sound pressure level,  $\text{SPL}''(i,k)$ , shall be determined from the narrow band analysis and used to compute a revised tone correction factor for that particular one-third octave band.

#### 4.4 Maximum tone corrected perceived noise level

4.4.1 The maximum tone corrected perceived noise level,  $\text{PNLTM}$ , shall be the maximum calculated value of the tone corrected perceived noise level  $\text{PNLT}(k)$ . It shall be calculated in accordance with the procedure of 4.3. To obtain a satisfactory noise time history, measurements shall be made at half-second time intervals.

*Note.*— Figure A1-2 is an example of a flyover noise time history where the maximum value is clearly indicated.

4.4.2 If there are no pronounced irregularities in the spectrum, even when examined by a narrow band analysis, then the procedure of 4.3 shall be disregarded since  $\text{PNLT}(k)$  would be identically equal to  $\text{PNL}(k)$ . For this case,  $\text{PNLTM}$  shall be the maximum value of  $\text{PNL}(k)$  and would equal  $\text{PNLM}$ .

#### 4.5 Duration correction

4.5.1 The duration correction factor,  $D$ , determined by the integration technique shall be defined by the expression:

$$D = 10 \log \left[ \left( \frac{1}{T} \right) \int_{t(1)}^{t(2)} \text{antilog} \frac{\text{PNLT}}{10} dt \right] - \text{PNLTM}$$

where  $T$  is a normalizing time constant, and  $\text{PNLTM}$  is the maximum value of  $\text{PNLT}$ .

4.5.1.1 If  $\text{PNLTM}$  is greater than 100 TPNdB,  $t(1)$  shall be the first point of time after which  $\text{PNLT}$  becomes greater than  $\text{PNLTM} - 10$ , and  $t(2)$  shall be the point of time after which  $\text{PNLT}$  remains constantly less than  $\text{PNLTM} - 10$ .

**Table A1-2. Tone correction factors**

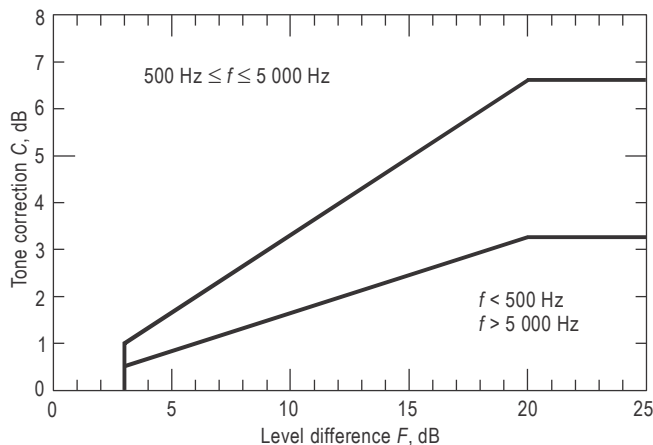

Frequency <i>f</i> , Hz	Level difference <i>F</i> , dB	Tone correction <i>C</i> , dB
$50 \leq f < 500$	$3^* \leq F < 20$	$F/6$
	$20 \leq F$	$3\frac{1}{3}$
$500 \leq f \leq 5\,000$	$3^* \leq F < 20$	$F/3$
	$20 \leq F$	$6\frac{2}{3}$
$5\,000 < f \leq 10\,000$	$3^* \leq F < 20$	$F/6$
	$20 \leq F$	$3\frac{1}{3}$

\* See Step 8 of 4.3.

4.5.1.2 If PNLTM is less than 100 TPNdB, *t*(1) shall be the first point of time after which PNLT becomes greater than 90 TPNdB and *t*(2) shall be the point of time after which PNLT remains constantly less than 90 TPNdB.

4.5.1.3 If PNLTM is less than 90 TPNdB, the duration correction shall be taken as equal to 0.

4.5.2 Since PNLT is calculated from measured values of SPL, there will, in general, be no obvious equation for PNLT as a function of time. Consequently, the equation shall be rewritten with a summation sign instead of an integral sign as follows:

$$D = 10 \log \left[ \left( \frac{1}{T} \right) \sum_{k=0}^{\frac{d}{\Delta t}} \Delta t \cdot \text{antilog} \frac{\text{PNLT}(k)}{10} \right] - \text{PNLTM}$$

where  $\Delta t$  is the length of the equal increments of time for which PNLT(*k*) is calculated and *d* is the time interval to the nearest 1.0 second during which PNLT(*k*) remains greater or equal either to PNLTM – 10 or to 90 according to the cases specified in 4.5.1.1 to 4.5.1.3.

**Table A1-3. Example of tone correction calculation for a turbofan engine**

①	②	③	④	⑤	⑥	⑦	⑧	⑨	⑩	⑪
Band (i)	f Hz	SPL dB	S dB Step 1	\u0394S  dB Step 2	SPL' dB Step 4	S' dB Step 5	\u0304s dB Step 6	SPL'' dB Step 7	F dB Step 8	C dB Step 9
1	50	—	—	—	—	—	—	—	—	—
2	63	—	—	—	—	—	—	—	—	—
3	80	70	—	—	70	-8	-2 <sup>1</sup> / <sub>3</sub>	70	—	—
4	100	62	-8	—	62	-8	+3 <sup>1</sup> / <sub>3</sub>	67 <sup>2</sup> / <sub>3</sub>	—	—
5	125	(70)	+(8)	16	71	+9	+6 <sup>2</sup> / <sub>3</sub>	71	—	—
6	160	80	+10	2	80	+9	+2 <sup>2</sup> / <sub>3</sub>	77 <sup>2</sup> / <sub>3</sub>	—	—
7	200	82	+(2)	8	82	+2	-1 <sup>1</sup> / <sub>3</sub>	80 <sup>1</sup> / <sub>3</sub>	—	—
8	250	(83)	+1	1	79	-3	-1 <sup>1</sup> / <sub>3</sub>	79	4	0.61
9	315	76	-(7)	8	76	-3	+ <sup>1</sup> / <sub>3</sub>	77 <sup>2</sup> / <sub>3</sub>	—	—
10	400	(80)	+(4)	11	78	+2	+1	78	—	0.17
11	500	80	0	4	80	+2	0	79	—	—
12	630	79	-1	1	79	-1	0	79	—	—
13	800	78	-1	0	78	-1	- <sup>1</sup> / <sub>3</sub>	79	—	—
14	1 000	80	+2	3	80	+2	- <sup>2</sup> / <sub>3</sub>	78 <sup>2</sup> / <sub>3</sub>	—	—
15	1 250	78	-2	4	78	-2	- <sup>1</sup> / <sub>3</sub>	78	—	—
16	1 600	76	-2	0	76	-2	+ <sup>1</sup> / <sub>3</sub>	77 <sup>2</sup> / <sub>3</sub>	—	—
17	2 000	79	+3	5	79	+3	+1	78	—	—
18	2 500	(85)	+6	3	79	0	- <sup>1</sup> / <sub>3</sub>	79	6	2
19	3 150	79	-(6)	12	79	0	-2 <sup>2</sup> / <sub>3</sub>	78 <sup>2</sup> / <sub>3</sub>	—	—
20	4 000	78	-1	5	78	-1	-6 <sup>1</sup> / <sub>3</sub>	76	—	—
21	5 000	71	-(7)	6	71	-7	-8	69 <sup>2</sup> / <sub>3</sub>	—	—
22	6 300	60	-11	4	60	-11	-8 <sup>2</sup> / <sub>3</sub>	61 <sup>2</sup> / <sub>3</sub>	—	—
23	8 000	54	-6	5	54	-6	-8	53	—	—
24	10 000	45	-9	3	45	-9	—	45	—	—
						-9				

Step 1	(3)(i) - (3)(i-1)
Step 2	(4)(i) - (4)(i-1)
Step 3	see instructions
Step 4	see instructions
Step 5	(6)(i) - (6)(i-1)

Step 6	[(7)(i) + (7)(i+1) + (7)(i+2)] \u2264 3
Step 7	(9)(i-1) + (8)(i-1)
Step 8	(3)(i) - (9)(i)
Step 9	see Table A1-2



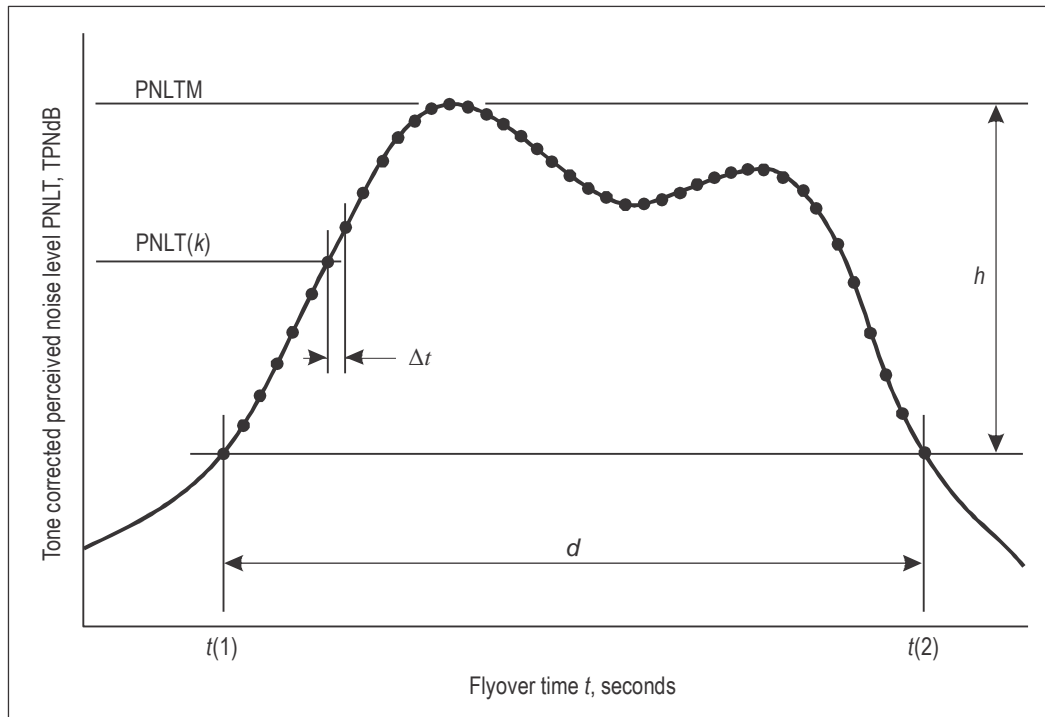

**Figure A1-2. Example of perceived noise level corrected for tones as a function of aircraft flyover time**

4.5.3 To obtain a satisfactory history of the perceived noise level,

- a) half-second time intervals for  $\Delta t$ , or
- b) a shorter time interval with approved limits and constants,

shall be used.

4.5.4 The following values for  $T$  and  $\Delta t$  shall be used in calculating  $D$  in the procedure given in 4.5.2:

$$T = 10 \text{ s, and}$$

$$\Delta t = 0.5 \text{ s}$$

Using the above values, the equation for  $D$  becomes

$$D = 10 \log \left[ \sum_{k=0}^{2d} \text{antilog} \frac{\text{PNLT}(k)}{10} \right] - \text{PNLTM} - 13$$

where the integer  $d$  is the duration time defined by the points corresponding to the values  $\text{PNLTM} - 10$  or  $90$  as the case may be.

4.5.5 If in the procedures given in 4.5.2, the limits of  $\text{PNLTM} - 10$  or  $90$  fall between the calculated  $\text{PNLT}(k)$  values (the usual case), the  $\text{PNLT}(k)$  values defining the limits of the duration interval shall be chosen from the  $\text{PNLT}(k)$  values closest to  $\text{PNLTM} - 10$  or  $90$  as the case may be.

#### 4.6 Effective perceived noise level

The total subjective effect of an aeroplane flyover, designated “effective perceived noise level”, EPNL, shall be equal to the algebraic sum of the maximum value of the tone corrected perceived noise level, PNLTM, and the duration correction,  $D$ . That is:

$$\text{EPNL} = \text{PNLTM} + D$$

where PNLTM and  $D$  are calculated in accordance with the procedures given in 4.2, 4.3, 4.4 and 4.5. If the duration correction  $D$  is negative and greater than PNLTM – 90 in absolute values,  $D$  shall be taken as equal to 90 – PNLTM.

### 5. REPORTING OF DATA TO THE CERTIFICATING AUTHORITY AND CORRECTING MEASURED DATA

#### 5.1 General

Data representing physical measurements or corrections to measured data shall be recorded in permanent form and appended to the record except that corrections to measurements for normal equipment response deviations need not be reported. All other corrections shall be approved. Attempts shall be made to keep to a minimum the individual errors inherent in each of the operations employed in obtaining the final data.

#### 5.2 Data reporting

5.2.1 Measured and corrected sound pressure levels shall be presented in one-third octave band levels obtained with equipment conforming to the Standards described in Section 3 of this appendix.

5.2.2 The type of equipment used for measurement and analysis of all acoustic aeroplane performance and meteorological data shall be reported.

5.2.3 The following atmospheric environmental data, measured immediately before, after, or during each test at the observation points prescribed in Section 2 of this appendix shall be reported:

- a) air temperature and relative humidity;
- b) maximum, minimum and average wind velocities;
- c) atmospheric pressure.

5.2.4 Comments on local topography, ground cover, and events that might interfere with sound recordings shall be reported.

5.2.5 The following aeroplane information shall be reported:

- a) type, model, serial numbers (if any) of aeroplane and engines;
- b) gross dimensions of aeroplane and location of engines;
- c) aeroplane gross mass for each test run;

- d) aeroplane configuration such as flap and landing gear position;
- e) indicated airspeed in kilometres per hour (knots);
- f) engine performance in terms of net thrust, engine pressure ratios, jet exhaust temperatures and fan or compressor shaft rotational speeds as determined from aeroplane instruments and manufacturer's data;
- g) aeroplane height above ground determined by a method independent of cockpit instrumentation, such as radar tracking, theodolite triangulation or photographic scaling techniques, to be approved by the certificating authorities.

5.2.6 Aeroplane speed and position and engine performance parameters shall be recorded at an approved sampling rate sufficient to correct to the noise certification reference conditions prescribed in this section and shall be synchronized with the noise measurement.

5.2.6.1 Lateral position relative to the extended centre line of the runway, configuration and gross mass shall be reported.

### 5.3 Noise certification reference conditions

Aeroplane position and performance data and the noise measurements shall be corrected to the following noise certification reference conditions:

- a) meteorological conditions:
  - 1) sea level atmospheric pressure of 1 013.25 hPa;
  - 2) ambient air temperature of 25°C, i.e. ISA + 10°C except that, at the discretion of the certificating authority, an alternative reference ambient air temperature of 15°C, i.e. ISA may be used;
  - 3) relative humidity of 70 per cent; and
  - 4) zero wind;
- b) aeroplane conditions:
  - 1) maximum take-off mass and landing mass at which noise certification is requested;
  - 2) approach angle of 3°; and
  - 3) aeroplane height of 120 m (394 ft) above the approach noise measuring station.

### 5.4 Data correction

5.4.1 The noise data shall be corrected to the noise certification reference conditions as stated in 5.3. The measured atmospheric conditions shall be those obtained in accordance with Section 2 of this appendix. Atmospheric attenuation of sound requirements are given in Section 8 of this appendix. If a reference ambient air temperature of 15°C is used (see 5.3 a) 2)), a further correction of +1 EPNdB shall be added to the noise levels obtained at the flyover measurement point.

5.4.2 The measured flight path shall be corrected by an amount equal to the difference between the applicant's predicted flight paths for the test conditions and for the noise certification reference conditions.

*Note.— Necessary corrections relating to aeroplane flight path or performance may be derived from approved data other than certification test data.*

5.4.2.1 The flight path correction procedure for approach noise shall be made with reference to a fixed aeroplane reference height and the reference approach angle. The effective perceived noise level correction shall be less than 2 EPNdB to allow for:

- a) the aeroplane not passing vertically above the measuring point;
- b) the difference between the reference height and the height of the aeroplane's ILS antenna from the approach measuring point; and
- c) the difference between the reference and the test approach angles.

*Note.*— Detailed correction requirements are given in Section 9 of this appendix.

5.4.3 Test results on specific measurement shall not be accepted if the difference in EPNL computed from measured data and that corrected to reference conditions exceeds 15 EPNdB.

5.4.4 If aeroplane sound pressure levels do not exceed the ambient sound pressure levels by at least 10 dB in any one-third octave band, approved corrections for the contribution of ambient sound pressure level to the observed sound pressure level shall be applied.

## 5.5 Validity of results

5.5.1 Three average EPNL values and their 90 per cent confidence limits shall be produced from the test results, each such value being the arithmetical average of the corrected acoustical measurements for all valid test runs at the appropriate measurement point (take-off, approach or sideline). If more than one acoustic measurement system is used at any single measurement location (such as for the symmetrical sideline measuring points), the resulting data for each test run shall be averaged as a single measurement.

5.5.2 The minimum sample size acceptable for each of the three certification measuring points shall be six. The samples shall be large enough to establish statistically for each of the three average noise certification levels a 90 per cent confidence limit not exceeding  $\pm 1.5$  EPNdB. No test result shall be omitted from the average process unless otherwise specified by the certifying authorities.

5.5.3 The average EPNL values and their 90 per cent confidence limits obtained by the foregoing process shall be those by which the noise performance of the aeroplane is assessed against the noise certification criteria, and shall be reported.

## 6. NOMENCLATURE

### 6.1 Symbols and units

*Note.*— The meanings of the various symbols in this appendix are as follows. It is recognized that differences may exist in the units and meanings of similar symbols in Appendix 2.

<i>Symbol</i>	<i>Unit</i>	<i>Meaning</i>
antilog	—	Antilogarithm to the base 10.
$C(k)$	dB	Tone correction factor. The factor to be added to $PNL(k)$ to account for the presence of spectral irregularities such as tones at the $k$ -th increment of time.

<i>Symbol</i>	<i>Unit</i>	<i>Meaning</i>
$d$	s	<i>Duration time.</i> The length of the significant noise time history being the time interval between the limits of $t(1)$ and $t(2)$ to the nearest second.
$D$	dB	<i>Duration correction.</i> The factor to be added to PNLTM to account for the duration of the noise.
EPNL	EPNdB	<i>Effective perceived noise level.</i> The value of PNL adjusted for both the spectral irregularities and the duration of the noise. (The unit EPNdB is used instead of the unit dB.)
$f(i)$	Hz	<i>Frequency.</i> The geometrical mean frequency for the $i$ -th one-third octave band.
$F(i,k)$	dB	<i>Delta-dB.</i> The difference between the original sound pressure level and the final background sound pressure level in the $i$ -th one-third octave band at the $k$ -th interval of time.
$h$	dB	<i>dB-down.</i> The level to be subtracted from PNLTM that defines the duration of the noise.
$H$	%	<i>Relative humidity.</i> The ambient atmospheric relative humidity.
$i$	—	<i>Frequency band index.</i> The numerical indicator that denotes any one of the 24 one-third octave bands with geometrical mean frequencies from 50 to 10 000 Hz.
$k$	—	<i>Time increment index.</i> The numerical indicator that denotes the number of equal time increments that have elapsed from a reference zero.
log	—	<i>Logarithm to the base 10.</i>
$\log n(a)$	—	<i>Noy discontinuity coordinate.</i> The $\log n$ value of the intersection point of the straight lines representing the variation of SPL with $\log n$ .
$M(b), M(c)$ , etc.	—	<i>Noy inverse slope.</i> The reciprocals of the slopes of straight lines representing the variation of SPL with $\log n$ .
$n$	noy	<i>Perceived noisiness.</i> The perceived noisiness at any instant of time that occurs in a specified frequency range.
$n(i,k)$	noy	<i>Perceived noisiness.</i> The perceived noisiness at the $k$ -th instant of time that occurs in the $i$ -th one-third octave band.
$n(k)$	noy	<i>Maximum perceived noisiness.</i> The maximum value of all of the 24 values of $n(i)$ that occurs at the $k$ -th instant of time.
$N(k)$	noy	<i>Total perceived noisiness.</i> The total perceived noisiness at the $k$ -th instant of time calculated from the 24 instantaneous values of $n(i,k)$ .
$p(b), p(c)$ , etc.	—	<i>Noy slope.</i> The slopes of straight lines representing the variation of SPL with $\log n$ .
PNL	PNdB	<i>Perceived noise level.</i> The perceived noise level at any instant of time. (The unit PNdB is used instead of the unit dB.)

<i>Symbol</i>	<i>Unit</i>	<i>Meaning</i>
PNL( <i>k</i> )	PNdB	<i>Perceived noise level.</i> The perceived noise level calculated from the 24 values of SPL( <i>i,k</i> ) at the <i>k</i> -th increment of time. (The unit PNdB is used instead of the unit dB.)
PNLM	PNdB	<i>Maximum perceived noise level.</i> The maximum value of PNL( <i>k</i> ). (The unit PNdB is used instead of the unit dB.)
PNLT	TPNdB	<i>Tone corrected perceived noise level.</i> The value of PNL adjusted for the spectral irregularities that occur at any instant of time. (The unit TPNdB is used instead of the unit dB.)
PNLT( <i>k</i> )	TPNdB	<i>Tone corrected perceived noise level.</i> The value of PNL( <i>k</i> ) adjusted for the spectral irregularities that occur at the <i>k</i> -th increment of time. (The unit TPNdB is used instead of the unit dB.)
PNLTM	TPNdB	<i>Maximum tone corrected perceived noise level.</i> The maximum value of PNLT( <i>k</i> ). (The unit TPNdB is used instead of the unit dB.)
<i>s(i,k)</i>	dB	<i>Slope of sound pressure level.</i> The change in level between adjacent one-third octave band sound pressure levels at the <i>i</i> -th band for the <i>k</i> -th instant of time.
$\Delta s(i,k)$	dB	<i>Change in slope of sound pressure level.</i>
<i>s'(i,k)</i>	dB	<i>Adjusted slope of sound pressure level.</i> The change in level between adjacent adjusted one-third octave band sound pressure levels at the <i>i</i> -th band for the <i>k</i> -th instant of time.
$\bar{s}(i,k)$	dB	<i>Average slope of sound pressure level.</i>
SPL	dB re 20 $\mu$ Pa	<i>Sound pressure level.</i> The sound pressure level at any instant of time that occurs in a specified frequency range.
SPL( <i>a</i> )	dB re 20 $\mu$ Pa	<i>Noy discontinuity coordinate.</i> The SPL value of the intersection point of the straight lines representing the variation of SPL with log <i>n</i> .
SPL( <i>b</i> ) SPL( <i>c</i> )	dB re 20 $\mu$ Pa	<i>Noy intercept.</i> The intercepts on the SPL-axis of the straight lines representing the variation of SPL with log <i>n</i> .
SPL( <i>i,k</i> )	dB re 20 $\mu$ Pa	<i>Sound pressure level.</i> The sound pressure level at the <i>k</i> -th instant of time that occurs in the <i>i</i> -th one-third octave band.
SPL'( <i>i,k</i> )	dB re 20 $\mu$ Pa	<i>Adjusted sound pressure level.</i> The first approximation to background sound pressure level in the <i>i</i> -th one-third octave band for the <i>k</i> -th instant of time.
SPL( <i>i</i> )	dB re 20 $\mu$ Pa	<i>Maximum sound pressure level.</i> The sound pressure level that occurs in the <i>i</i> -th one-third octave band of the spectrum for PNLTM.
SPL( <i>i</i> ) <sub><i>c</i></sub>	dB re 20 $\mu$ Pa	<i>Corrected maximum sound pressure level.</i> The sound pressure level that occurs in the <i>i</i> -th one-third octave band of the spectrum for PNLTM corrected for atmospheric sound absorption.
SPL''( <i>i,k</i> )	dB re 20 $\mu$ Pa	<i>Final background sound pressure level.</i> The second and final approximation to background sound pressure level in the <i>i</i> -th one-third octave band for the <i>k</i> -th instant of time.

<i>Symbol</i>	<i>Unit</i>	<i>Meaning</i>
$t$	s	<i>Elapsed time.</i> The length of time measured from a reference zero.
$t_1, t_2$	s	<i>Time limit.</i> The beginning and end of the significant noise time history defined by $h$ .
$\Delta t$	s	<i>Time increment.</i> The equal increments of time for which PNL( $k$ ) and PNLT( $k$ ) are calculated.
$T$	s	<i>Normalizing time constant.</i> The length of time used as a reference in the integration method for computing duration corrections, where $T = 10$ s.
$t(^{\circ}\text{C})$	$^{\circ}\text{C}$	<i>Temperature.</i> The ambient atmospheric temperature.
$\alpha(i)$	dB/100 m	<i>Test atmospheric absorption.</i> The atmospheric attenuation of sound that occurs in the $i$ -th one-third octave band for the measured atmospheric temperature and relative humidity.
$\alpha(i)_o$	dB/100 m	<i>Reference atmospheric absorption.</i> The atmospheric attenuation of sound that occurs in the $i$ -th one-third octave band for a reference atmospheric temperature and relative humidity.
$\beta$	degrees	<i>First constant* climb angle.</i>
$\gamma$	degrees	<i>Second constant** climb angle.</i>
$\delta$	degrees	<i>Thrust cutback angles.</i> The angles defining the points on the take-off flight path at which thrust reduction is started and ended, respectively.
$\varepsilon$	degrees	
$\eta$	degrees	<i>Approach angle.</i>
$\eta_r$	degrees	<i>Reference approach angle.</i>
$\theta$	degrees	<i>Take-off noise angle.</i> The angle between the flight path and noise path for take-off operations. It is identical for both measured and corrected flight paths.
$\lambda$	degrees	<i>Approach noise angle.</i> The angle between the flight path and the noise path for approach operations. It is identical for both measured and corrected flight paths.
$\Delta_1$	EPNdB	<i>PNLT correction.</i> The correction to be added to the EPNL calculated from measured data to account for noise level changes due to differences in atmospheric absorption and noise path length between reference and test conditions.
$\Delta_2$	EPNdB	<i>Noise path duration correction.</i> The correction to be added to the EPNL calculated from measured data to account for noise level changes due to the noise duration because of differences in flyover altitude between reference and test conditions.
$\Delta_3$	EPNdB	<i>Mass correction.</i> The correction to be added to the EPNL calculated from measured data to account for noise level changes due to differences between maximum mass and actual mass of the test aeroplane.

\* Gear up, speed of at least  $V_2 + 19$  km/h ( $V_2 + 10$  kt), take-off thrust.

\*\* Gear up, speed of at least  $V_2 + 19$  km/h ( $V_2 + 10$  kt), after cutback.

<i>Symbol</i>	<i>Unit</i>	<i>Meaning</i>
$\Delta_4$	EPNdB	<i>Approach angle correction.</i> The correction to be added to the EPNL calculated from measured data to account for noise level changes due to differences between the reference and the test approach angles.
$\Delta AB$	metres	<i>Take-off profile changes.</i> The algebraic changes in the basic parameters defining the take-off profile due to differences between reference and test conditions.
$\Delta\beta$	degrees	
$\Delta\gamma$	degrees	
$\Delta\delta$	degrees	
$\Delta\varepsilon$	degrees	

## 6.2 Flight profile identification positions

<i>Position</i>	<i>Description</i>
A	Start of take-off roll.
B	Lift-off.
C	Start of first constant climb.
D	Start of thrust reduction.
E	Start of second constant climb.
$E_c$	Start of second constant climb on corrected flight path.
F	End of noise certification take-off flight path.
$F_c$	End of noise certification corrected take-off flight path.
G	Start of noise certification approach flight path.
$G_r$	Start of noise certification approach on reference flight path.
H	Position on approach path directly above noise measuring station.
$H_r$	Position on reference approach path directly above noise measuring station.
I	Start of level-off.
$I_r$	Start of level-off on reference approach flight path.
J	Touchdown.
K	Flyover noise measurement point.
L	Lateral noise measurement point(s) (not on flight track).
M	End of noise certification take-off flight track.
N	Approach noise measurement point.
O	Threshold of approach end of runway.
P	Start of noise certification approach flight track.
Q	Position on measured take-off flight path corresponding to apparent PNLTM at station K. (See 9.2.)
$Q_c$	Position on corrected take-off flight path corresponding to PNLTM at station K. (See 9.2.)
R	Position on measured take-off flight path nearest to station K.



<i>Position</i>	<i>Description</i>
R <sub>c</sub>	Position on corrected take-off flight path nearest to station K.
S	Position on measured approach flight path corresponding to PNLTM at station N.
S <sub>r</sub>	Position on reference approach flight path corresponding to PNLTM at station N.
T	Position on measured approach flight path nearest to station N.
T <sub>r</sub>	Position on reference approach flight path nearest to station N.
X	Position on measured take-off flight path corresponding to PNLTM at station L.

### 6.3 Flight profile distances

<i>Distance</i>	<i>Unit</i>	<i>Meaning</i>
AB	metres	<i>Length of take-off roll.</i> The distance along the runway between the start of take-off roll and lift-off.
AK	metres	<i>Take-off measurement distance.</i> The distance from the start of roll to the take-off noise measurement station along the extended centre line of the runway.
AM	metres	<i>Take-off flight track distance.</i> The distance from the start of roll to the take-off flight track position along the extended centre line of the runway for which the position of the aeroplane need no longer be recorded.
KQ	metres	<i>Measured take-off noise path.</i> The distance from station K to the measured aeroplane position Q.
KQ <sub>c</sub>	metres	<i>Corrected take-off noise path.</i> The distance from station K to the corrected aeroplane position Q <sub>c</sub> .
KR	metres	<i>Measured take-off minimum distance.</i> The distance from station K to point R on the measured flight path.
KR <sub>c</sub>	metres	<i>Corrected take-off minimum distance.</i> The distance from station K to point R <sub>c</sub> on the corrected flight path.
LX	metres	<i>Measured sideline noise path.</i> The distance from station L to the measured aeroplane position X.
NH	metres (feet)	<i>Aeroplane approach height.</i> The height of the aeroplane above the approach measuring station.
NH <sub>r</sub>	metres (feet)	<i>Reference approach height.</i> The height of the reference approach path above the approach measuring station.
NS	metres	<i>Measured approach noise path.</i> The distance from station N to the measured aeroplane position S.
NS <sub>r</sub>	metres	<i>Reference approach noise path.</i> The distance from station N to the reference aeroplane position S <sub>r</sub> .
NT	metres	<i>Measured approach minimum distance.</i> The distance from station N to point T on the measured flight path.
NT <sub>r</sub>	metres	<i>Reference approach minimum distance.</i> The distance from station N to point T <sub>r</sub> on the corrected flight path.
ON	metres	<i>Approach measurement distance.</i> The distance from the runway threshold to the approach measurement station along the extended centre line of the runway.

<i>Distance</i>	<i>Unit</i>	<i>Meaning</i>
OP	metres	<i>Approach flight track distance.</i> The distance from the runway threshold to the approach flight track position along the extended centre line of the runway for which the position of the aeroplane need no longer be recorded.

## 7. MATHEMATICAL FORMULATION OF NOY TABLES

*Note 1.— The relationship between sound pressure level and perceived noisiness given in Table A1-1 is illustrated in Figure A1-3. The variation of SPL with log n for a given one-third octave band is expressed by either one or two straight lines depending upon the frequency range. Figure A1-3 a) illustrates the double line case for frequencies below 400 Hz and above 6 300 Hz and Figure A1-3 b) illustrates the single line case for all other frequencies.*

*The important aspects of the mathematical formulation are:*

- a) the slopes of the straight lines  $p(b)$  and  $p(c)$ ;*
- b) the intercepts of the lines on the SPL-axis,  $SPL(b)$  and  $SPL(c)$ ; and*
- c) the coordinates of the discontinuity,  $SPL(a)$  and  $\log n(a)$ .*

*Note 2.— Mathematically the relationship is expressed as follows:*

*Case 1: Figure A1-3 a):  $f < 400$  Hz  
 $f > 6\,300$  Hz*

$$SPL(a) = \frac{p(c) SPL(b) - p(b) SPL(c)}{p(c) - p(b)}$$

$$\log n(a) = \frac{SPL(c) - SPL(b)}{p(b) - p(c)}$$

- a)  $SPL < SPL(a)$*

$$n = \text{antilog} \frac{SPL - SPL(b)}{p(b)}$$

- b)  $SPL \geq SPL(a)$*

$$n = \text{antilog} \frac{SPL - SPL(c)}{p(c)}$$

- c)  $\log n < \log n(a)$*

$$SPL = p(b) \log n + SPL(b)$$

- d)  $\log n \geq \log n(a)$*

$$SPL = p(c) \log n + SPL(c)$$

Case 2: Figure A1-3 b):  $400 \leq f \leq 6\,300$  Hz

$$n = \text{antilog} \frac{\text{SPL} - \text{SPL}(c)}{p(c)}$$

$$\text{SPL} = p(c) \log n + \text{SPL}(c)$$

Note 3.— If the reciprocals of the slopes are defined as:

$$M(b) = 1/p(b)$$

$$M(c) = 1/p(c)$$

the equations in Note 2 can be written,

Case 1: Figure A1-3 a):  $f < 400$  Hz  
 $f > 6\,300$  Hz

$$\text{SPL}(a) = \frac{M(b) \text{SPL}(b) - M(c) \text{SPL}(c)}{M(b) - M(c)}$$

$$\log n(a) = \frac{M(b) M(c) [\text{SPL}(c) - \text{SPL}(b)]}{M(c) - M(b)}$$

a)  $\text{SPL} < \text{SPL}(a)$

$$n = \text{antilog} M(b) [\text{SPL} - \text{SPL}(b)]$$

b)  $\text{SPL} \geq \text{SPL}(a)$

$$n = \text{antilog} M(c) [\text{SPL} - \text{SPL}(c)]$$

c)  $\log n < \log n(a)$

$$\text{SPL} = \frac{\log n}{M(b)} + \text{SPL}(b)$$

d)  $\log n \geq \log n(a)$

$$\text{SPL} = \frac{\log n}{M(c)} + \text{SPL}(c)$$

Case 2: Figure A1-3 b):  $400 \leq f \leq 6\,300$  Hz

$$n = \text{antilog} M(c) [\text{SPL} - \text{SPL}(c)]$$

$$\text{SPL} = \frac{\log n}{M(c)} + \text{SPL}(c)$$

Note 4.— Table A1-4 lists the values of the important constants necessary to calculate sound pressure level as a function of perceived noisiness.

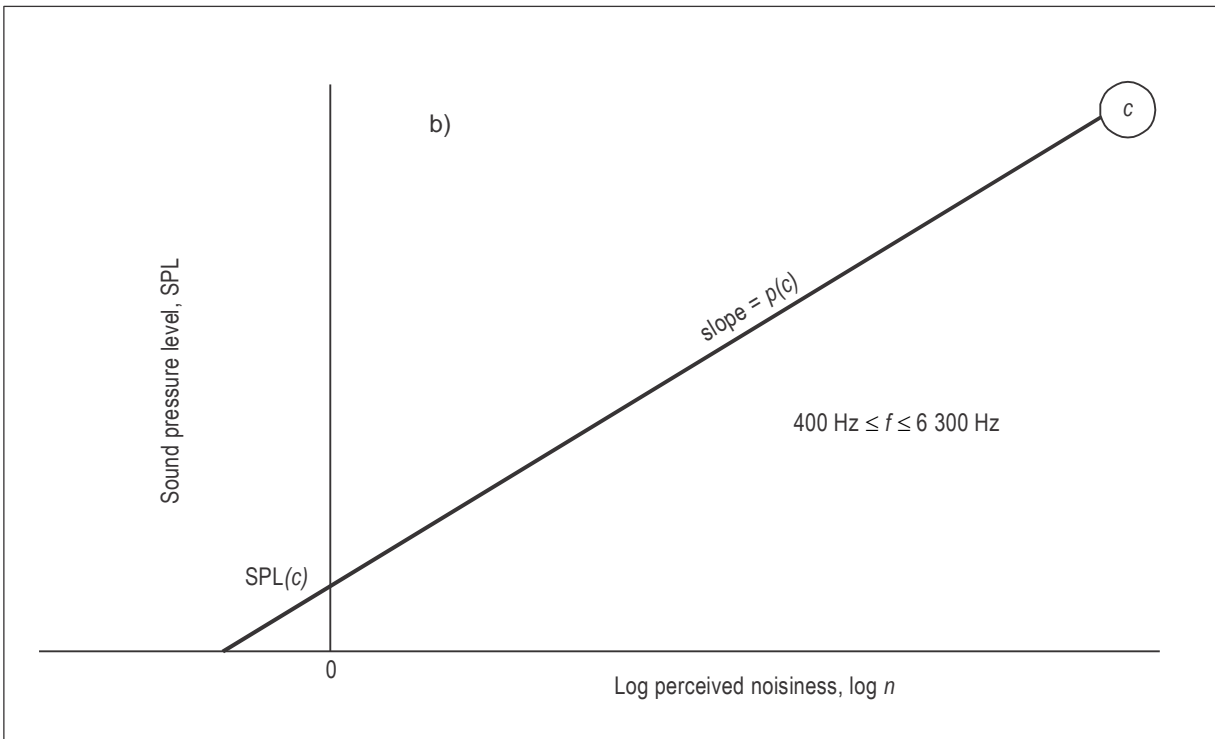
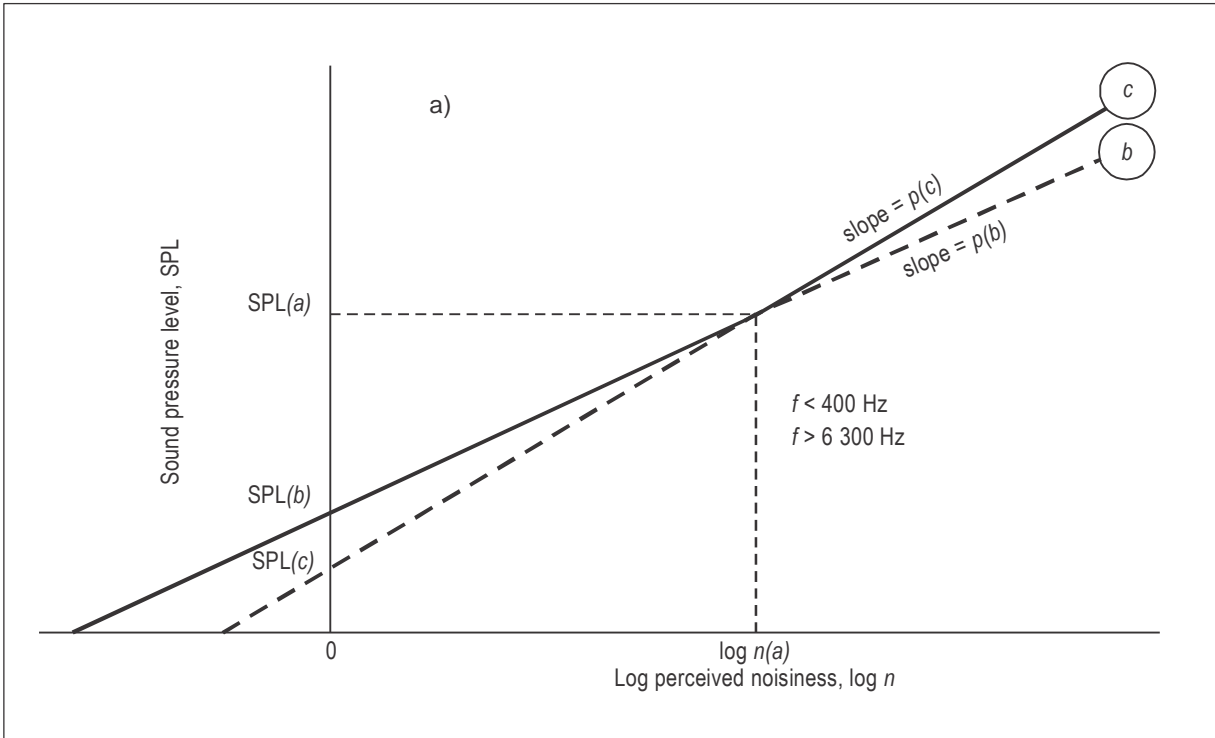

Figure A1-3. Sound pressure level as a function of perceived noisiness

**Table A1-4. Constants for mathematically formulated noy values**

Band (i)	f Hz	M(b)	SPL(b) dB	SPL(a) dB	M(c)	SPL(c) dB	
1	50	0.043478	64	91.0	0.030103	52	
2	63	0.040570	60	85.9	↑	51	
3	80	0.036831	56	87.3		49	
4	100	”	53	79.9		47	
5	125	0.035336	51	79.8		46	
6	160	0.033333	48	76.0		45	
7	200	”	46	74.0		43	
8	250	0.032051	44	74.9		42	
9	315	0.030675	42	94.6		41	
10	400	—	—	—		↓	40
11	500	—	—	—	40		
12	630	—	—	—	40		
13	800	—	—	—	40		
14	1 000	—	—	—	40		
15	1 250	—	—	—	0.030103		38
16	1 600	—	—	—	0.029960		34
17	2 000	—	—	—	↑		32
18	2 500	—	—	—			30
19	3 150	—	—	—			29
20	4 000	—	—	—		29	
21	5 000	—	—	—		30	
22	6 300	—	—	—	↓	31	
23	8 000	0.042285	37	44.3		34	
24	10 000	0.042285	41	50.7	0.029960	37	

NOT APPLICABLE

## 8. SOUND ATTENUATION IN AIR

8.1 The atmospheric attenuation of sound shall be determined in accordance with the procedure presented below.

8.2 The relationship between sound attenuation, frequency, temperature and humidity is expressed by the following equations:

$$\alpha(i) = 10^{[2.05 \log(f_o/1000) + 1.1394 \times 10^{-3}\theta - 1.916984]} + \eta(\delta) \times 10^{[\log(f_o) + 8.42994 \times 10^{-3}\theta - 2.755624]}$$

$$\delta = \sqrt{\frac{1010}{f_o}} 10^{(\log H - 1.328924 + 3.179768 \times 10^{-2}\theta)} \times 10^{(-2.173716 \times 10^{-4}\theta^2 + 1.7496 \times 10^{-6}\theta^3)}$$

where:

$\eta(\delta)$  is given by Table A1-5 and  $f_o$  by Table A1-6;

$\alpha(i)$  being the attenuation coefficient in dB/100 m;

$\theta$  being the temperature in °C; and

$H$  being the relative humidity.

8.3 The equations given in 8.2 are convenient for calculation by means of a computer. For use in other cases, numerical values determined from the equations are given in Tables A1-7 to A1-16.

**Table A1-5**

$\delta$	$\eta$	$\delta$	$\eta$
0.00	0.000	2.30	0.495
0.25	0.315	2.50	0.450
0.50	0.700	2.80	0.400
0.60	0.840	3.00	0.370
0.70	0.930	3.30	0.330
0.80	0.975	3.60	0.300
0.90	0.996	4.15	0.260
1.00	1.000	4.45	0.245
1.10	0.970	4.80	0.230
1.20	0.900	5.25	0.220
1.30	0.840	5.70	0.210
1.50	0.750	6.05	0.205
1.70	0.670	6.50	0.200
2.00	0.570	7.00	0.200
		10.00	0.200

**Table A1-6**

<i>one-third octave centre frequency</i>	$f_o$ (Hz)	<i>one-third octave centre frequency</i>	$f_o$ (Hz)
50	50	800	800
63	63	1 000	1 000
80	80	1 250	1 250
100	100	1 600	1 600
125	125	2 000	2 000
160	160	2 500	2 500
200	200	3 150	3 150
250	250	4 000	4 000
315	315	5 000	4 500
400	400	6 300	5 600
500	500	8 000	7 100
630	630	10 000	9 000

**Table A1-7. Sound attenuation coefficient in dB/100 m**

Band centre frequency	Relative humidity = 10%											
	Temperature, °C											
	Hz	-10	-5	0	5	10	15	20	25	30	35	40
50	0.1	0.1	0.0	0.0	0.0	0.0	0.0	0.0	0.0	0.0	0.0	0.0
63	0.1	0.1	0.1	0.1	0.0	0.0	0.0	0.0	0.0	0.0	0.0	0.0
80	0.1	0.1	0.1	0.1	0.1	0.1	0.0	0.0	0.0	0.1	0.1	0.1
100	0.1	0.2	0.1	0.1	0.1	0.1	0.1	0.1	0.1	0.1	0.1	0.1
125	0.2	0.2	0.2	0.1	0.1	0.1	0.1	0.1	0.1	0.1	0.1	0.1
160	0.2	0.2	0.3	0.2	0.2	0.1	0.1	0.1	0.1	0.1	0.1	0.1
200	0.2	0.3	0.3	0.3	0.2	0.2	0.1	0.1	0.1	0.1	0.1	0.2
250	0.2	0.4	0.4	0.4	0.3	0.3	0.2	0.2	0.2	0.2	0.2	0.2
315	0.2	0.4	0.5	0.6	0.5	0.4	0.3	0.2	0.2	0.2	0.2	0.2
400	0.3	0.5	0.7	0.8	0.6	0.5	0.4	0.3	0.3	0.3	0.3	0.3
500	0.3	0.5	0.8	1.0	0.9	0.7	0.6	0.5	0.4	0.4	0.4	0.4
630	0.3	0.6	0.9	1.2	1.2	1.0	0.9	0.7	0.6	0.5	0.5	0.5
800	0.4	0.6	1.0	1.5	1.7	1.5	1.2	1.0	0.8	0.7	0.6	0.6
1 000	0.4	0.7	1.2	1.8	2.1	2.0	1.7	1.4	1.2	1.0	0.9	0.9
1 250	0.4	0.8	1.3	2.1	2.6	2.8	2.4	2.0	1.7	1.4	1.2	1.2
1 600	0.5	0.9	1.4	2.3	3.3	3.8	3.4	2.9	2.4	2.0	1.7	1.7
2 000	0.6	1.0	1.6	2.6	3.9	4.7	4.7	4.1	3.4	2.8	2.3	2.3
2 500	0.7	1.1	1.8	2.9	4.5	5.8	6.4	5.6	4.8	4.0	3.3	3.3
3 150	0.8	1.2	2.0	3.2	5.1	7.1	8.3	7.7	6.8	5.7	4.8	4.8
4 000	0.9	1.4	2.3	3.6	5.7	8.5	10.5	11.0	9.6	8.3	6.9	6.9
5 000	1.0	1.6	2.4	3.8	6.1	9.2	11.7	12.8	11.3	9.9	8.3	8.3
6 300	1.3	1.9	2.8	4.3	6.8	10.4	14.2	16.4	15.5	13.7	11.7	11.7
8 000	1.6	2.3	3.4	5.0	7.7	11.8	17.0	20.8	22.0	19.4	16.8	16.8
10 000	2.1	2.9	4.1	6.0	8.9	13.4	19.9	25.9	29.5	27.2	24.1	24.1
12 500	2.9	3.7	5.0	7.1	10.3	15.3	22.7	31.2	36.9	37.6	33.4	33.4

**Table A1-8. Sound attenuation coefficient in dB/100 m**

Band centre frequency	Relative humidity = 20%											
	Temperature, °C											
	Hz	-10	-5	0	5	10	15	20	25	30	35	40
50	0.0	0.0	0.0	0.0	0.0	0.0	0.0	0.0	0.0	0.0	0.0	0.0
63	0.1	0.0	0.0	0.0	0.0	0.0	0.0	0.0	0.0	0.0	0.0	0.0
80	0.1	0.1	0.0	0.0	0.0	0.0	0.0	0.0	0.1	0.1	0.1	0.1
100	0.1	0.1	0.1	0.0	0.0	0.0	0.1	0.1	0.1	0.1	0.1	0.1
125	0.2	0.1	0.1	0.1	0.0	0.0	0.1	0.1	0.1	0.1	0.1	0.1
160	0.2	0.2	0.1	0.1	0.1	0.1	0.1	0.1	0.1	0.1	0.1	0.1
200	0.3	0.2	0.2	0.1	0.1	0.1	0.1	0.1	0.1	0.1	0.1	0.2
250	0.4	0.3	0.3	0.2	0.2	0.1	0.1	0.1	0.2	0.2	0.2	0.2
315	0.4	0.5	0.4	0.3	0.2	0.2	0.2	0.2	0.2	0.2	0.2	0.2
400	0.5	0.6	0.5	0.4	0.3	0.3	0.2	0.2	0.3	0.3	0.3	0.3
500	0.6	0.8	0.7	0.6	0.5	0.4	0.3	0.3	0.3	0.3	0.4	0.4
630	0.7	1.0	1.0	0.8	0.7	0.5	0.4	0.4	0.4	0.4	0.5	0.5
800	0.8	1.2	1.4	1.2	0.9	0.7	0.6	0.5	0.5	0.6	0.6	0.6
1 000	0.9	1.4	1.8	1.6	1.3	1.0	0.8	0.7	0.7	0.7	0.8	0.8
1 250	0.9	1.6	2.2	2.2	1.8	1.5	1.2	1.0	0.9	0.9	1.0	1.0
1 600	1.1	1.9	2.7	3.1	2.6	2.1	1.7	1.4	1.2	1.2	1.3	1.3
2 000	1.2	2.0	3.2	3.9	3.6	3.0	2.5	2.0	1.7	1.5	1.6	1.6
2 500	1.3	2.3	3.7	4.9	5.0	4.2	3.5	2.8	2.3	2.0	2.0	2.0
3 150	1.5	2.5	4.2	6.0	6.8	5.8	4.9	4.0	3.3	2.8	2.7	2.7
4 000	1.7	2.9	4.8	7.2	8.7	8.2	7.1	5.9	4.9	4.0	3.6	3.6
5 000	1.9	3.1	5.1	7.9	9.8	9.7	8.4	7.0	5.9	4.8	4.2	4.2
6 300	2.2	3.5	5.7	9.0	12.0	13.3	11.5	9.9	8.2	6.8	5.8	5.8
8 000	2.7	4.1	6.5	10.4	14.8	17.4	16.2	14.1	12.0	10.0	8.3	8.3
10 000	3.3	4.9	7.5	11.8	17.7	22.0	23.1	20.1	17.2	14.5	12.1	12.1
12 500	4.1	5.9	8.8	13.4	20.5	27.1	30.6	27.5	24.2	20.6	17.4	17.4

**Table A1-9. Sound attenuation coefficient in dB/100 m**

Band centre frequency	Relative humidity = 30%											
	Temperature, °C											
	–10	–5	0	5	10	15	20	25	30	35	40	
Hz												
50	0.0	0.0	0.0	0.0	0.0	0.0	0.0	0.0	0.0	0.0	0.0	0.0
63	0.0	0.0	0.0	0.0	0.0	0.0	0.0	0.0	0.0	0.0	0.0	0.0
80	0.1	0.0	0.0	0.0	0.0	0.0	0.0	0.0	0.0	0.1	0.1	0.1
100	0.1	0.1	0.0	0.0	0.0	0.0	0.0	0.1	0.1	0.1	0.1	0.1
125	0.1	0.1	0.1	0.1	0.1	0.1	0.1	0.1	0.1	0.1	0.1	0.1
160	0.2	0.1	0.1	0.1	0.1	0.1	0.1	0.1	0.1	0.1	0.1	0.1
200	0.2	0.2	0.1	0.1	0.1	0.1	0.1	0.1	0.1	0.1	0.1	0.2
250	0.3	0.2	0.2	0.1	0.1	0.1	0.1	0.1	0.1	0.2	0.2	0.2
315	0.4	0.3	0.2	0.2	0.2	0.1	0.2	0.2	0.2	0.2	0.2	0.2
400	0.6	0.5	0.4	0.3	0.2	0.2	0.2	0.2	0.2	0.3	0.3	0.3
500	0.7	0.6	0.5	0.4	0.3	0.3	0.3	0.3	0.3	0.3	0.3	0.4
630	0.9	0.9	0.7	0.5	0.4	0.3	0.3	0.4	0.4	0.4	0.4	0.5
800	1.1	1.3	1.0	0.8	0.6	0.5	0.4	0.5	0.5	0.6	0.6	0.6
1 000	1.3	1.6	1.4	1.1	0.9	0.7	0.6	0.6	0.6	0.7	0.7	0.8
1 250	1.5	2.0	1.9	1.6	1.2	0.9	0.8	0.7	0.8	0.9	0.9	1.0
1 600	1.7	2.5	2.7	2.2	1.8	1.4	1.1	1.0	1.0	1.1	1.1	1.3
2 000	1.9	3.0	3.6	3.1	2.5	2.0	1.6	1.4	1.3	1.4	1.4	1.6
2 500	2.1	3.5	4.4	4.2	3.5	2.8	2.2	1.9	1.7	1.8	1.8	2.0
3 150	2.3	4.0	5.5	5.9	4.9	4.0	3.3	2.6	2.3	2.3	2.3	2.5
4 000	2.6	4.5	6.8	7.9	6.9	5.8	4.7	3.8	3.3	3.1	3.1	3.3
5 000	2.8	4.8	7.4	9.0	8.2	6.9	5.7	4.6	3.9	3.6	3.6	3.7
6 300	3.2	5.3	8.6	11.1	11.3	9.6	8.0	6.6	5.4	4.8	4.8	4.7
8 000	3.8	6.1	9.9	13.9	15.6	13.6	11.5	9.5	7.9	6.8	6.8	6.4
10 000	4.5	7.1	11.4	16.9	20.3	19.1	16.6	13.9	11.6	9.7	9.7	8.8
12 500	5.5	8.3	13.0	20.0	25.3	26.6	23.0	19.6	16.4	13.8	13.8	12.1

**Table A1-10. Sound attenuation coefficient in dB/100 m**

Band centre frequency	Relative humidity = 40%											
	Temperature, °C											
	–10	–5	0	5	10	15	20	25	30	35	40	
Hz												
50	0.0	0.0	0.0	0.0	0.0	0.0	0.0	0.0	0.0	0.0	0.0	0.0
63	0.0	0.0	0.0	0.0	0.0	0.0	0.0	0.0	0.0	0.0	0.0	0.0
80	0.0	0.0	0.0	0.0	0.0	0.0	0.0	0.0	0.0	0.1	0.1	0.1
100	0.1	0.0	0.0	0.0	0.0	0.0	0.0	0.1	0.1	0.1	0.1	0.1
125	0.1	0.1	0.0	0.0	0.1	0.1	0.1	0.1	0.1	0.1	0.1	0.1
160	0.1	0.1	0.1	0.1	0.1	0.1	0.1	0.1	0.1	0.1	0.1	0.1
200	0.2	0.1	0.1	0.1	0.1	0.1	0.1	0.1	0.1	0.1	0.1	0.2
250	0.2	0.2	0.1	0.1	0.1	0.1	0.1	0.1	0.1	0.2	0.2	0.2
315	0.3	0.2	0.2	0.1	0.1	0.1	0.1	0.2	0.2	0.2	0.2	0.2
400	0.5	0.4	0.3	0.2	0.2	0.2	0.2	0.2	0.2	0.3	0.3	0.3
500	0.6	0.5	0.4	0.3	0.2	0.2	0.2	0.3	0.3	0.3	0.3	0.4
630	0.9	0.7	0.5	0.4	0.3	0.3	0.3	0.4	0.4	0.4	0.4	0.5
800	1.2	1.0	0.8	0.6	0.4	0.4	0.4	0.5	0.5	0.6	0.6	0.6
1 000	1.4	1.4	1.1	0.8	0.6	0.5	0.5	0.6	0.6	0.7	0.7	0.8
1 250	1.8	1.9	1.5	1.2	0.9	0.7	0.7	0.7	0.8	0.9	0.9	1.0
1 600	2.1	2.6	2.1	1.7	1.3	1.0	0.9	0.9	1.0	1.1	1.1	1.3
2 000	2.5	3.2	2.9	2.4	1.9	1.5	1.2	1.2	1.3	1.4	1.4	1.6
2 500	2.8	4.0	4.1	3.3	2.6	2.1	1.7	1.6	1.7	1.8	1.8	2.0
3 150	3.2	4.9	5.6	4.7	3.8	3.0	2.4	2.1	2.1	2.3	2.3	2.5
4 000	3.6	5.9	7.2	6.5	5.4	4.3	3.5	3.0	2.8	3.0	3.0	3.3
5 000	3.8	6.3	8.1	7.7	6.5	5.2	4.2	3.5	3.3	3.4	3.4	3.7
6 300	4.3	7.2	10.0	10.7	9.0	7.3	6.0	4.9	4.4	4.3	4.3	4.7
8 000	5.0	8.3	12.3	14.4	12.6	10.6	8.7	7.1	6.1	5.8	5.8	6.2
10 000	5.8	9.5	14.8	18.4	17.8	15.2	12.7	10.5	8.8	8.1	8.1	8.1
12 500	6.9	10.9	17.2	22.9	24.7	21.2	17.8	14.9	12.4	10.9	10.9	10.6



**Table A1-11. Sound attenuation coefficient in dB/100 m**

Band centre frequency	Relative humidity = 50%											
	Temperature, °C											
	Hz	-10	-5	0	5	10	15	20	25	30	35	40
50	0.0	0.0	0.0	0.0	0.0	0.0	0.0	0.0	0.0	0.0	0.0	0.0
63	0.0	0.0	0.0	0.0	0.0	0.0	0.0	0.0	0.0	0.0	0.0	0.0
80	0.0	0.0	0.0	0.0	0.0	0.0	0.0	0.0	0.0	0.1	0.1	0.1
100	0.0	0.0	0.0	0.0	0.0	0.0	0.0	0.1	0.1	0.1	0.1	0.1
125	0.1	0.0	0.0	0.0	0.1	0.1	0.1	0.1	0.1	0.1	0.1	0.1
160	0.1	0.1	0.1	0.1	0.1	0.1	0.1	0.1	0.1	0.1	0.1	0.1
200	0.1	0.1	0.1	0.1	0.1	0.1	0.1	0.1	0.1	0.1	0.1	0.2
250	0.2	0.1	0.1	0.1	0.1	0.1	0.1	0.1	0.1	0.2	0.2	0.2
315	0.3	0.2	0.1	0.1	0.1	0.1	0.1	0.2	0.2	0.2	0.2	0.2
400	0.4	0.3	0.2	0.2	0.2	0.2	0.2	0.2	0.2	0.3	0.3	0.3
500	0.5	0.4	0.3	0.2	0.2	0.2	0.2	0.3	0.3	0.3	0.3	0.4
630	0.7	0.6	0.4	0.3	0.3	0.3	0.3	0.3	0.4	0.4	0.4	0.5
800	1.0	0.8	0.6	0.5	0.4	0.4	0.4	0.4	0.5	0.5	0.6	0.6
1 000	1.4	1.1	0.9	0.6	0.5	0.5	0.5	0.5	0.6	0.6	0.7	0.8
1 250	1.8	1.6	1.2	0.9	0.7	0.6	0.7	0.7	0.7	0.8	0.9	1.0
1 600	2.3	2.2	1.8	1.3	1.0	0.9	0.9	0.9	0.9	1.0	1.1	1.3
2 000	2.8	3.1	2.4	1.9	1.5	1.2	1.1	1.2	1.2	1.3	1.4	1.6
2 500	3.4	4.0	3.4	2.7	2.1	1.6	1.5	1.5	1.7	1.7	1.8	2.0
3 150	4.0	5.1	4.7	3.8	3.0	2.3	2.0	1.9	2.1	2.1	2.3	2.5
4 000	4.6	6.4	6.7	5.5	4.4	3.4	2.8	2.6	2.7	2.7	3.0	3.3
5 000	4.9	7.2	7.9	6.5	5.2	4.2	3.4	3.1	3.1	3.1	3.4	3.7
6 300	5.4	8.6	10.2	8.9	7.3	5.9	4.7	4.1	4.0	4.0	4.3	4.7
8 000	6.2	10.2	13.1	12.5	10.5	8.6	6.9	5.8	5.4	5.4	5.7	6.2
10 000	7.2	11.9	16.4	17.8	15.0	12.4	10.2	8.4	7.5	7.5	7.4	8.1
12 500	8.4	13.6	20.1	23.4	20.6	17.5	14.4	11.9	10.4	10.4	9.9	10.5

**Table A1-12. Sound attenuation coefficient in dB/100 m**

Band centre frequency	Relative humidity = 60%											
	Temperature, °C											
	Hz	-10	-5	0	5	10	15	20	25	30	35	40
50	0.0	0.0	0.0	0.0	0.0	0.0	0.0	0.0	0.0	0.0	0.0	0.0
63	0.0	0.0	0.0	0.0	0.0	0.0	0.0	0.0	0.0	0.0	0.0	0.0
80	0.0	0.0	0.0	0.0	0.0	0.0	0.0	0.0	0.0	0.1	0.1	0.1
100	0.0	0.0	0.0	0.0	0.0	0.0	0.0	0.1	0.1	0.1	0.1	0.1
125	0.1	0.0	0.0	0.0	0.1	0.1	0.1	0.1	0.1	0.1	0.1	0.1
160	0.1	0.1	0.1	0.1	0.1	0.1	0.1	0.1	0.1	0.1	0.1	0.1
200	0.1	0.1	0.1	0.1	0.1	0.1	0.1	0.1	0.1	0.1	0.1	0.2
250	0.2	0.1	0.1	0.1	0.1	0.1	0.1	0.1	0.1	0.2	0.2	0.2
315	0.2	0.2	0.1	0.1	0.1	0.1	0.1	0.2	0.2	0.2	0.2	0.2
400	0.3	0.2	0.2	0.2	0.2	0.2	0.2	0.2	0.2	0.3	0.3	0.3
500	0.5	0.3	0.2	0.2	0.2	0.2	0.2	0.3	0.3	0.3	0.3	0.4
630	0.6	0.5	0.3	0.3	0.3	0.3	0.3	0.3	0.4	0.4	0.4	0.5
800	0.9	0.7	0.5	0.4	0.4	0.4	0.4	0.4	0.5	0.5	0.6	0.6
1 000	1.2	1.0	0.7	0.5	0.5	0.5	0.5	0.5	0.6	0.6	0.7	0.8
1 250	1.7	1.3	1.0	0.7	0.6	0.6	0.7	0.7	0.7	0.8	0.9	1.0
1 600	2.3	1.9	1.5	1.1	0.9	0.8	0.9	0.9	0.9	1.0	1.1	1.3
2 000	2.9	2.6	2.1	1.6	1.2	1.1	1.1	1.2	1.2	1.3	1.4	1.6
2 500	3.6	3.6	2.9	2.2	1.7	1.4	1.4	1.5	1.5	1.7	1.8	2.0
3 150	4.4	5.0	4.1	3.2	2.5	2.0	1.8	1.9	2.1	2.1	2.3	2.5
4 000	5.3	6.6	5.7	4.6	3.6	2.8	2.5	2.5	2.7	2.7	3.0	3.3
5 000	5.8	7.4	6.8	5.5	4.3	3.4	2.9	2.9	3.1	3.1	3.4	3.7
6 300	6.6	9.2	9.3	7.7	6.1	4.9	4.0	3.8	4.0	4.0	4.3	4.7
8 000	7.6	11.4	13.0	10.9	8.9	7.2	5.8	5.2	5.2	5.2	5.7	6.2
10 000	8.7	13.8	16.9	15.3	12.8	10.4	8.5	7.3	7.0	7.0	7.4	8.1
12 500	10.0	16.1	21.1	21.2	18.0	14.8	12.2	10.2	9.5	9.5	9.6	10.5

**Table A1-13. Sound attenuation coefficient in dB/100 m**

Band centre frequency	Relative humidity = 70%											
	Temperature, °C											
	Hz	-10	-5	0	5	10	15	20	25	30	35	40
50	0.0	0.0	0.0	0.0	0.0	0.0	0.0	0.0	0.0	0.0	0.0	0.0
63	0.0	0.0	0.0	0.0	0.0	0.0	0.0	0.0	0.0	0.0	0.0	0.0
80	0.0	0.0	0.0	0.0	0.0	0.0	0.0	0.0	0.0	0.1	0.1	0.1
100	0.0	0.0	0.0	0.0	0.0	0.0	0.0	0.1	0.1	0.1	0.1	0.1
125	0.0	0.0	0.0	0.0	0.1	0.1	0.1	0.1	0.1	0.1	0.1	0.1
160	0.1	0.1	0.1	0.1	0.1	0.1	0.1	0.1	0.1	0.1	0.1	0.1
200	0.1	0.1	0.1	0.1	0.1	0.1	0.2	0.1	0.1	0.1	0.1	0.2
250	0.1	0.1	0.1	0.1	0.1	0.1	0.2	0.1	0.2	0.2	0.2	0.2
315	0.2	0.1	0.1	0.1	0.1	0.1	0.2	0.2	0.2	0.2	0.2	0.2
400	0.3	0.2	0.2	0.2	0.2	0.2	0.2	0.2	0.3	0.3	0.3	0.3
500	0.4	0.3	0.2	0.2	0.2	0.2	0.3	0.3	0.3	0.4	0.4	0.4
630	0.6	0.4	0.3	0.3	0.3	0.3	0.3	0.4	0.4	0.4	0.4	0.5
800	0.8	0.6	0.4	0.4	0.4	0.4	0.4	0.5	0.5	0.6	0.6	0.6
1 000	1.1	0.8	0.6	0.5	0.4	0.5	0.5	0.6	0.7	0.7	0.7	0.8
1 250	1.5	1.1	0.9	0.7	0.6	0.6	0.7	0.7	0.8	0.9	1.0	1.0
1 600	2.1	1.7	1.2	0.9	0.8	0.8	0.9	1.0	1.0	1.1	1.1	1.3
2 000	2.9	2.3	1.8	1.3	1.0	1.0	1.1	1.2	1.3	1.4	1.4	1.6
2 500	3.7	3.2	2.5	1.9	1.5	1.3	1.4	1.5	1.7	1.8	1.8	2.0
3 150	4.6	4.4	3.5	2.7	2.1	1.8	1.8	1.9	2.1	2.3	2.3	2.5
4 000	5.7	6.3	5.1	4.0	3.1	2.5	2.3	2.5	2.7	3.0	3.0	3.3
5 000	6.3	7.3	6.0	4.7	3.7	3.0	2.7	2.9	3.1	3.4	3.4	3.7
6 300	7.5	9.3	8.2	6.6	5.2	4.2	3.6	3.6	4.0	4.3	4.3	4.7
8 000	8.8	11.8	11.6	9.5	7.6	6.1	5.1	4.9	5.2	5.7	5.7	6.2
10 000	10.2	14.8	16.4	13.7	11.1	9.0	7.4	6.8	6.8	7.4	7.4	8.1
12 500	11.6	18.0	21.4	18.8	15.7	12.8	10.5	9.2	9.0	9.6	9.6	10.5

**Table A1-14. Sound attenuation coefficient in dB/100 m**

Band centre frequency	Relative humidity = 80%											
	Temperature, °C											
	Hz	-10	-5	0	5	10	15	20	25	30	35	40
50	0.0	0.0	0.0	0.0	0.0	0.0	0.0	0.0	0.0	0.0	0.0	0.0
63	0.0	0.0	0.0	0.0	0.0	0.0	0.0	0.0	0.0	0.0	0.0	0.0
80	0.0	0.0	0.0	0.0	0.0	0.0	0.0	0.0	0.0	0.1	0.1	0.1
100	0.0	0.0	0.0	0.0	0.0	0.0	0.0	0.1	0.1	0.1	0.1	0.1
125	0.0	0.0	0.0	0.0	0.1	0.1	0.1	0.1	0.1	0.1	0.1	0.1
160	0.1	0.1	0.1	0.1	0.1	0.1	0.1	0.1	0.1	0.1	0.1	0.1
200	0.1	0.1	0.1	0.1	0.1	0.1	0.1	0.1	0.1	0.1	0.1	0.2
250	0.1	0.1	0.1	0.1	0.1	0.1	0.1	0.1	0.1	0.2	0.2	0.2
315	0.2	0.1	0.1	0.1	0.1	0.1	0.1	0.2	0.2	0.2	0.2	0.2
400	0.2	0.2	0.1	0.2	0.2	0.2	0.2	0.2	0.2	0.3	0.3	0.3
500	0.3	0.2	0.2	0.2	0.2	0.2	0.2	0.3	0.3	0.3	0.3	0.4
630	0.5	0.3	0.3	0.2	0.3	0.3	0.3	0.3	0.4	0.4	0.4	0.5
800	0.7	0.5	0.4	0.3	0.3	0.4	0.4	0.4	0.5	0.5	0.6	0.6
1 000	1.0	0.7	0.5	0.4	0.4	0.5	0.5	0.6	0.6	0.7	0.7	0.8
1 250	1.3	1.0	0.7	0.6	0.6	0.6	0.7	0.7	0.8	0.9	0.9	1.0
1 600	1.9	1.5	1.1	0.8	0.7	0.8	0.9	0.9	1.0	1.1	1.1	1.3
2 000	2.6	2.0	1.5	1.1	1.0	1.0	1.1	1.2	1.3	1.4	1.4	1.6
2 500	3.6	2.9	2.2	1.6	1.3	1.3	1.4	1.5	1.7	1.8	1.8	2.0
3 150	4.7	4.0	3.1	2.4	1.9	1.7	1.8	1.9	2.1	2.3	2.3	2.5
4 000	5.9	5.6	4.5	3.4	2.7	2.3	2.3	2.5	2.7	3.0	3.0	3.3
5 000	6.6	6.6	5.3	4.1	3.2	2.7	2.6	2.8	3.1	3.4	3.4	3.7
6 300	8.1	9.1	7.4	5.9	4.6	3.7	3.4	3.6	4.0	4.3	4.3	4.7
8 000	9.8	12.0	10.4	8.4	6.7	5.4	4.8	4.8	5.2	5.7	5.7	6.2
10 000	11.5	15.3	14.8	12.2	9.8	7.8	6.7	6.4	6.8	7.4	7.4	8.1
12 500	13.3	18.9	20.5	17.0	13.9	11.3	9.4	8.7	8.9	9.6	9.6	10.5

**Table A1-15. Sound attenuation coefficient in dB/100 m**

Band centre frequency	Relative humidity = 90%											
	Temperature, °C											
	Hz	-10	-5	0	5	10	15	20	25	30	35	40
50	0.0	0.0	0.0	0.0	0.0	0.0	0.0	0.0	0.0	0.0	0.0	0.0
63	0.0	0.0	0.0	0.0	0.0	0.0	0.0	0.0	0.0	0.0	0.0	0.0
80	0.0	0.0	0.0	0.0	0.0	0.0	0.0	0.0	0.0	0.1	0.1	0.1
100	0.0	0.0	0.0	0.0	0.0	0.0	0.0	0.1	0.1	0.1	0.1	0.1
125	0.0	0.0	0.0	0.0	0.1	0.1	0.1	0.1	0.1	0.1	0.1	0.1
160	0.1	0.1	0.1	0.1	0.1	0.1	0.1	0.1	0.1	0.1	0.1	0.1
200	0.1	0.1	0.1	0.1	0.1	0.1	0.1	0.1	0.1	0.1	0.1	0.2
250	0.1	0.1	0.1	0.1	0.1	0.1	0.1	0.1	0.1	0.2	0.2	0.2
315	0.1	0.1	0.1	0.1	0.1	0.1	0.1	0.2	0.2	0.2	0.2	0.2
400	0.2	0.2	0.1	0.2	0.2	0.2	0.2	0.2	0.2	0.3	0.3	0.3
500	0.3	0.2	0.2	0.2	0.2	0.2	0.2	0.3	0.3	0.3	0.3	0.4
630	0.4	0.3	0.2	0.2	0.3	0.3	0.3	0.3	0.4	0.4	0.4	0.5
800	0.6	0.4	0.3	0.3	0.3	0.4	0.4	0.4	0.5	0.5	0.6	0.6
1 000	0.9	0.6	0.5	0.4	0.4	0.5	0.5	0.6	0.6	0.7	0.7	0.8
1 250	1.2	0.9	0.6	0.5	0.6	0.6	0.7	0.7	0.8	0.8	0.9	1.0
1 600	1.7	1.3	0.9	0.7	0.7	0.8	0.9	0.9	1.0	1.1	1.1	1.3
2 000	2.4	1.8	1.3	1.0	0.9	1.0	1.1	1.2	1.3	1.4	1.4	1.6
2 500	3.3	2.6	1.9	1.4	1.2	1.3	1.4	1.5	1.7	1.8	1.8	2.0
3 150	4.6	3.6	2.8	2.1	1.7	1.6	1.8	1.9	2.1	2.3	2.3	2.5
4 000	6.0	5.1	4.0	3.0	2.4	2.2	2.3	2.5	2.7	3.0	3.0	3.3
5 000	6.7	6.0	4.8	3.7	2.9	2.6	2.6	2.8	3.1	3.4	3.4	3.7
6 300	8.3	8.3	6.7	5.2	4.0	3.4	3.3	3.6	4.0	4.3	4.3	4.7
8 000	10.4	11.7	9.5	7.6	6.0	4.9	4.5	4.8	5.2	5.7	5.7	6.2
10 000	12.6	15.4	13.5	11.0	8.8	7.1	6.3	6.3	6.8	7.4	7.4	8.1
12 500	14.8	19.4	18.6	15.4	12.4	10.1	8.7	8.3	8.9	9.6	9.6	10.5

**Table A1-16. Sound attenuation coefficient in dB/100 m**

Band centre frequency	Relative humidity = 100%											
	Temperature, °C											
	Hz	-10	-5	0	5	10	15	20	25	30	35	40
50	0.0	0.0	0.0	0.0	0.0	0.0	0.0	0.0	0.0	0.0	0.0	0.0
63	0.0	0.0	0.0	0.0	0.0	0.0	0.0	0.0	0.0	0.0	0.0	0.0
80	0.0	0.0	0.0	0.0	0.0	0.0	0.0	0.0	0.0	0.1	0.1	0.1
100	0.0	0.0	0.0	0.0	0.0	0.0	0.0	0.1	0.1	0.1	0.1	0.1
125	0.0	0.0	0.0	0.0	0.1	0.1	0.1	0.1	0.1	0.1	0.1	0.1
160	0.1	0.1	0.1	0.1	0.1	0.1	0.1	0.1	0.1	0.1	0.1	0.1
200	0.1	0.1	0.1	0.1	0.1	0.1	0.1	0.1	0.1	0.1	0.1	0.2
250	0.1	0.1	0.1	0.1	0.1	0.1	0.1	0.1	0.1	0.2	0.2	0.2
315	0.1	0.1	0.1	0.1	0.1	0.1	0.1	0.2	0.2	0.2	0.2	0.2
400	0.2	0.1	0.1	0.2	0.2	0.2	0.2	0.2	0.2	0.3	0.3	0.3
500	0.3	0.2	0.2	0.2	0.2	0.2	0.2	0.3	0.3	0.3	0.3	0.4
630	0.4	0.3	0.2	0.2	0.3	0.3	0.3	0.3	0.4	0.4	0.4	0.5
800	0.6	0.4	0.3	0.3	0.3	0.4	0.4	0.4	0.5	0.5	0.6	0.6
1 000	0.8	0.6	0.4	0.4	0.4	0.5	0.5	0.6	0.6	0.7	0.7	0.8
1 250	1.1	0.8	0.6	0.5	0.6	0.6	0.7	0.7	0.8	0.9	0.9	1.0
1 600	1.6	1.2	0.8	0.7	0.7	0.8	0.9	0.9	1.0	1.1	1.1	1.3
2 000	2.2	1.6	1.2	0.9	0.9	1.0	1.1	1.2	1.3	1.4	1.4	1.6
2 500	3.0	2.3	1.7	1.3	1.2	1.3	1.4	1.5	1.7	1.8	1.8	2.0
3 150	4.2	3.3	2.5	1.9	1.6	1.6	1.8	1.9	2.1	2.3	2.3	2.5
4 000	5.9	4.7	3.6	2.7	2.2	2.1	2.3	2.5	2.7	3.0	3.0	3.3
5 000	6.8	5.6	4.3	3.3	2.6	2.4	2.6	2.8	3.1	3.4	3.4	3.7
6 300	8.5	7.6	6.0	4.7	3.7	3.3	3.3	3.6	4.0	4.3	4.3	4.7
8 000	10.7	10.8	8.7	6.8	5.3	4.5	4.4	4.8	5.2	5.7	5.7	6.2
10 000	13.3	15.1	12.5	10.0	7.9	6.5	6.0	6.3	6.8	7.4	7.4	8.1
12 500	16.0	19.5	17.2	14.0	11.3	9.2	8.2	8.2	8.9	9.6	9.6	10.5

## 9. DETAILED CORRECTION PROCEDURES

### 9.1 Introduction

9.1.1 When the noise certification test conditions are not identical to the noise certification reference conditions, appropriate corrections shall be made to the EPNL calculated from the measured data by the methods of this section.

*Note 1.— Differences between reference and test conditions which lead to corrections can result from the following:*

- a) atmospheric absorption of sound under test conditions different from reference;
- b) test flight path at altitude different from reference; and
- c) test mass different from maximum.

*Note 2.— Negative correction can arise if the atmospheric absorption of sound under test conditions is less than reference and also if the test flight path is at a lower altitude than reference.*

*The take-off test flight path can occur at a higher altitude than reference if the meteorological conditions permit superior aeroplane performance (“cold day” effect). Conversely, the “hot day” effect can cause the take-off test flight path to occur at a lower altitude than reference. The approach test flight path can occur at either higher or lower altitudes than reference irrespective of the meteorological conditions.*

9.1.2 The measured noise values shall be properly corrected to the reference conditions, either by the correction procedures presented as follows or by an integrated programme which shall be approved as being equivalent.

9.1.2.1 Correction procedures shall consist of one or more values added algebraically to the EPNL calculated as if the tests were conducted completely under the noise certification reference conditions.

9.1.2.2 The flight profiles shall be determined for both take-off and approach, and for both reference and test conditions. The test procedures shall require noise and flight path recordings with a synchronized time signal from which the test profile can be delineated, including the aeroplane position for which PNLTM is observed at the noise measuring station. For take-off, a flight profile corrected to reference conditions shall be derived from data approved by the certifying authority.

*Note.— For approach, the reference profile is defined by the reference conditions in 5.3.*

9.1.2.3 The differing noise path lengths from the aeroplane to the noise measuring station corresponding to PNLTM shall be determined for the test and reference conditions. The SPL values in the spectrum of PNLTM shall then be corrected for the effects of:

- a) change in atmospheric sound absorption;
- b) atmospheric sound absorption on the change in noise path length; and
- c) inverse square law on the change in noise path length.

9.1.2.4 The corrected values of SPL shall then be converted to PNL from which PNLTM is subtracted.

*Note.— The difference represents the correction to be added algebraically to the EPNL calculated from the measured data.*

9.1.3 The minimum distances from both the test and reference profiles to the noise measuring station shall be calculated and used to determine a noise duration correction due to the change in the altitude of aeroplane flyover. The duration correction shall be added algebraically to the EPNL calculated from the measured data.

9.1.4 From manufacturer's data (approved by the certificating authority) in the form of curves, tables or in some other manner giving the variation of EPNL with take-off mass and also for landing mass, corrections shall be determined to be added to the EPNL calculated from the measured data to account for noise level changes due to differences between maximum take-off mass and landing mass and test aeroplane mass.

9.1.5 From manufacturer's data (approved by the certificating authority) in the form of curves, tables or in some manner giving the variation of EPNL with approach angle, corrections shall be determined to be added algebraically to the EPNL calculated from measured data to account for noise level changes due to differences between the reference and the test approach angles.

## 9.2 Take-off profiles

*Note.*—

- a) *Figure A1-4 illustrates a typical take-off profile. The aeroplane begins the take-off roll at point A, lifts off at point B, and initiates the first constant climb at point C at an angle  $\beta$ . The noise abatement thrust cutback is started at point D and completed at point E where the second constant climb is defined by the angle  $\gamma$  (usually expressed in terms of the gradient in per cent).*
- b) *The end of the noise certification take-off flight path is represented by aeroplane position F whose vertical projection on the flight track (extended centre line of the runway) is point M. The position of the aeroplane is recorded for a distance AM of at least 11 km (6 NM).*
- c) *Position K is the take-off noise measuring station whose distance AK is the specified take-off measurement distance. Position L is the sideline noise measuring station located on a line parallel to and the specified distance from the runway centre line where the noise level during take-off is greatest.*
- d) *The thrust settings after thrust reduction, if used, under the test conditions are such as would produce at least the minimum certification gradient for the reference conditions of atmosphere and mass.*
- e) *The take-off profile is associated with the following five parameters: AB, the length of take-off roll;  $\beta$ , the first constant climb angle;  $\gamma$ , the second constant climb angle; and  $\delta$  and  $\epsilon$ , the thrust cutback angles. These five parameters are functions of the aeroplane performance, mass and atmospheric conditions (ambient air temperature, pressure, and wind velocity). If the test atmospheric conditions are not equal to the reference atmospheric conditions, the corresponding test and reference profile parameters will be different as shown in Figure A1-5. The profile parameter changes (identified as  $\Delta AB$ ,  $\Delta\beta$ ,  $\Delta\gamma$ ,  $\Delta\delta$  and  $\Delta\epsilon$ ) can be derived from the manufacturer's data (approved by the certificating authority) and are used to define the flight profile corrected to the atmospheric reference conditions, the aeroplane mass being unchanged from that of the test. The relationships between the measured and corrected take-off flight profiles can then be used to determine the corrections which are applied to the EPNL calculated from the measured data.*
- f) *Figure A1-6 illustrates portions of the measured and corrected take-off flight paths including the significant geometrical relationships influencing sound propagation. EF represents the second constant measured flight path with climb angle  $\gamma$ , and  $E_c F_c$  represents the second constant corrected flight path at different altitude and with different climb angle  $\gamma + \Delta\gamma$ .*
- g) *Position Q represents the aeroplane location on the measured take-off flight path for which PNLTM is observed at the noise measuring station K, and  $Q_c$  is the corresponding position on the corrected flight path. The measured and*

corrected noise propagation paths are  $KQ$  and  $KQ_c$ , respectively, which are assumed to form the same angle  $\theta$  with their flight paths. This assumption of constant angle  $\theta$  is one which may not be valid in all cases. Future refinement shall be sought. However, for the present application of this test procedure, any differences are considered small.

- h) Position  $R$  represents the point on the measured take-off flight path nearest the noise measuring station  $K$ , and  $R_c$  is the corresponding position on the corrected flight path. The minimum distance to the measured and corrected flight paths are indicated by the lines  $KR$  and  $KR_c$ , respectively, which are normal to their flight paths.

If two peak values of PNL<sub>T</sub> are observed during flyover which differ by less than 2 TPN<sub>dB</sub> that noise level which, when corrected to reference conditions, gives the greater value shall be used in the computation for EPNL at the reference conditions. In that case the point corresponding to the second peak shall be obtained on the corrected flight path by applying manufacturer's approved data.

### 9.3 Approach profiles

Note.—

- a) Figure A1-7 illustrates a typical approach profile. The beginning of the noise certification approach profile is represented by aeroplane position  $G$  whose vertical projection on the flight track (extended centre line of the runway) is point  $P$ . The position of the aeroplane is recorded for a distance  $PO$  from the runway threshold  $O$  of at least 7.4 km (4 NM).
- b) The aeroplane approaches at an angle  $\eta$ , passes vertically over the noise measuring station  $N$  at a height of  $NH$ , begins the level-off at position  $I$ , and touches down at position  $J$ .
- c) The approach profile is defined by the approach angle  $\eta$  and the height  $NH$  which are functions of the aeroplane operating conditions controlled by the pilot. If the measured approach profile parameters are different from the corresponding reference approach parameters (Figure A1-8), corrections are applied to the EPNL calculated from the measured data.
- d) Figure A1-9 illustrates portions of the measured and reference approach flight paths including the significant geometrical relationships influencing sound propagation.  $GI$  represents the measured approach path with approach angle  $\eta$ , and  $G_rI_r$  represents the reference approach flight path at reference altitude and the reference approach angle  $\eta_r$ .
- e) Position  $S$  represents the aeroplane location on the measured approach flight path for which PNL<sub>TM</sub> is observed at the noise measuring station  $N$ , and  $S_r$  is the corresponding position on the reference approach flight path. The measured and corrected noise propagation paths are  $NS$  and  $NS_r$ , respectively, which form the same angle  $\lambda$  with their flight paths.
- f) Position  $T$  represents the point on the measured approach flight path nearest the noise measuring station  $N$ , and  $T_r$  is the corresponding point on the reference approach flight path. The minimum distances to the measured and reference flight paths are indicated by the lines  $NT$  and  $NT_r$ , respectively, which are normal to their flight paths.

### 9.4 PNL<sub>T</sub> corrections

9.4.1 Whenever the ambient atmospheric conditions of temperature and relative humidity differ from the reference conditions and/or whenever the measured take-off and approach flight paths differ from the reference flight paths respectively, corrections to the EPNL values calculated from the measured data shall be applied. These corrections shall be calculated as described below:

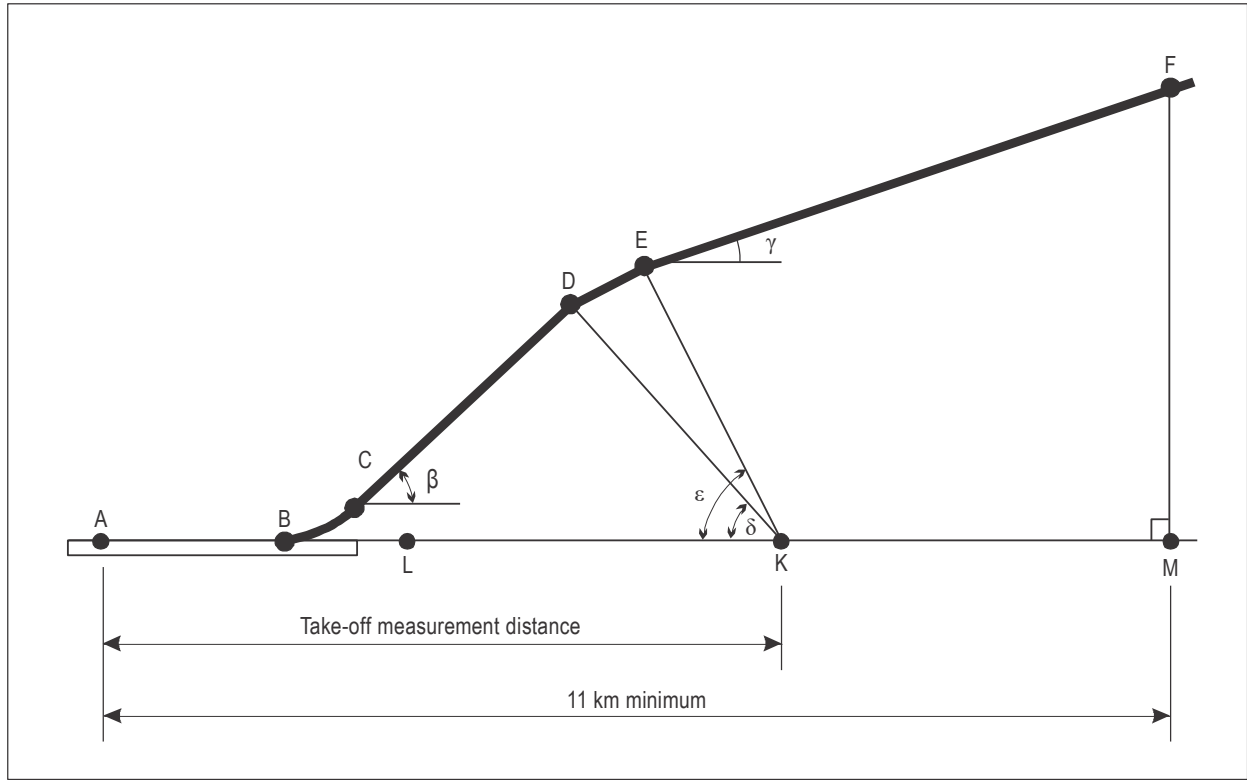

Figure A1-4. Measured take-off profile

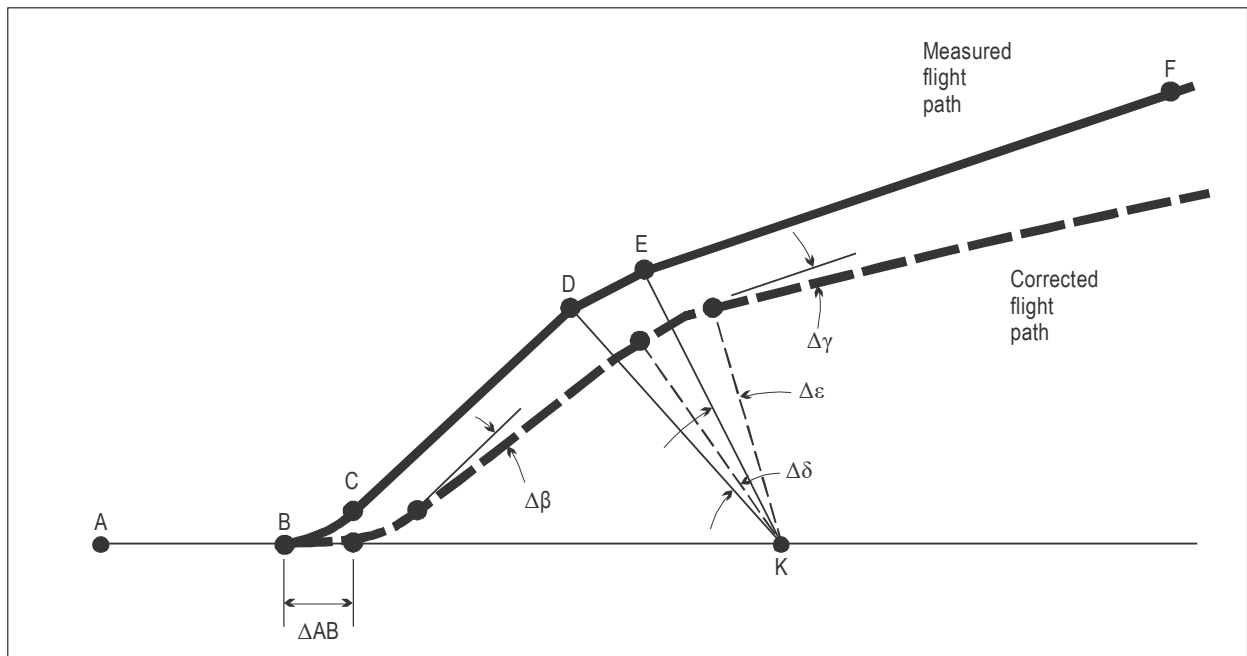

Figure A1-5. Comparison of measured and corrected take-off profiles

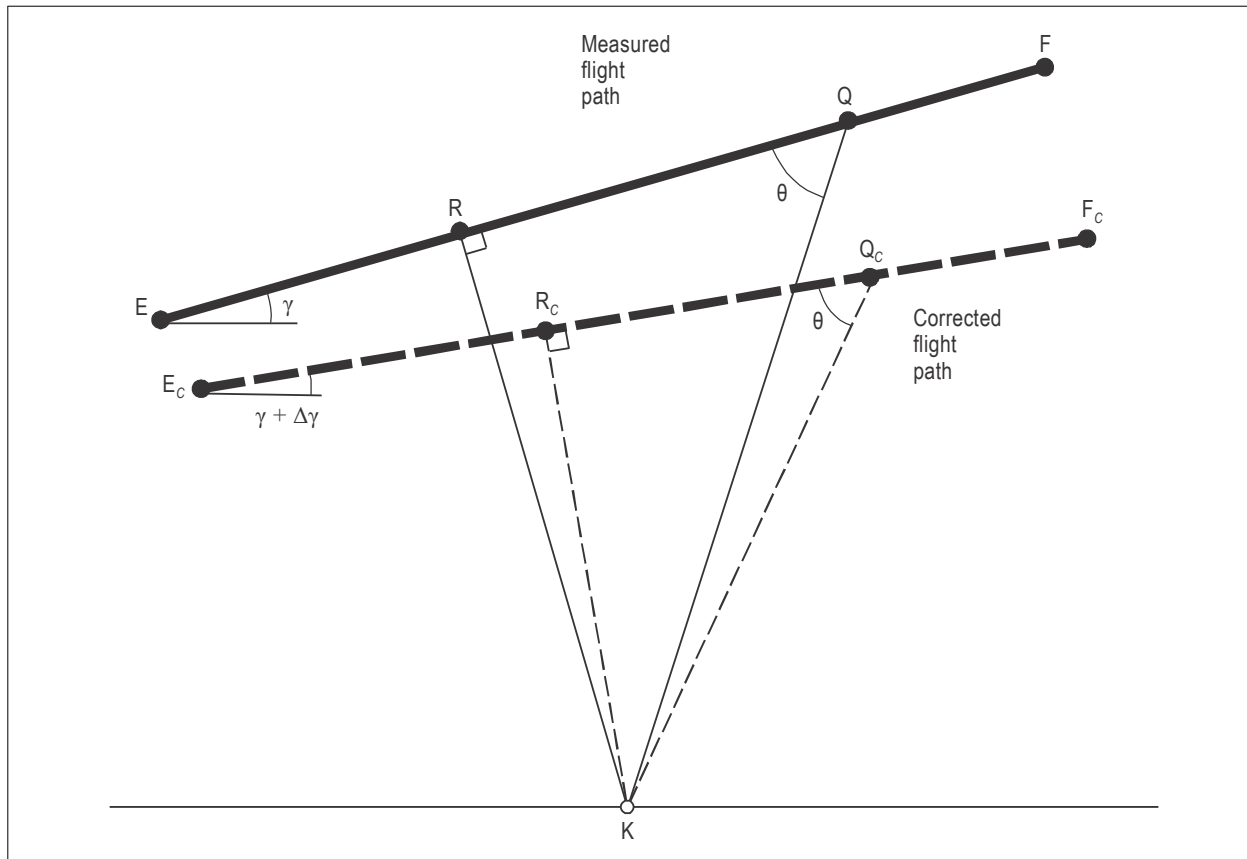

Figure A1-6. Take-off profile characteristics influencing sound level

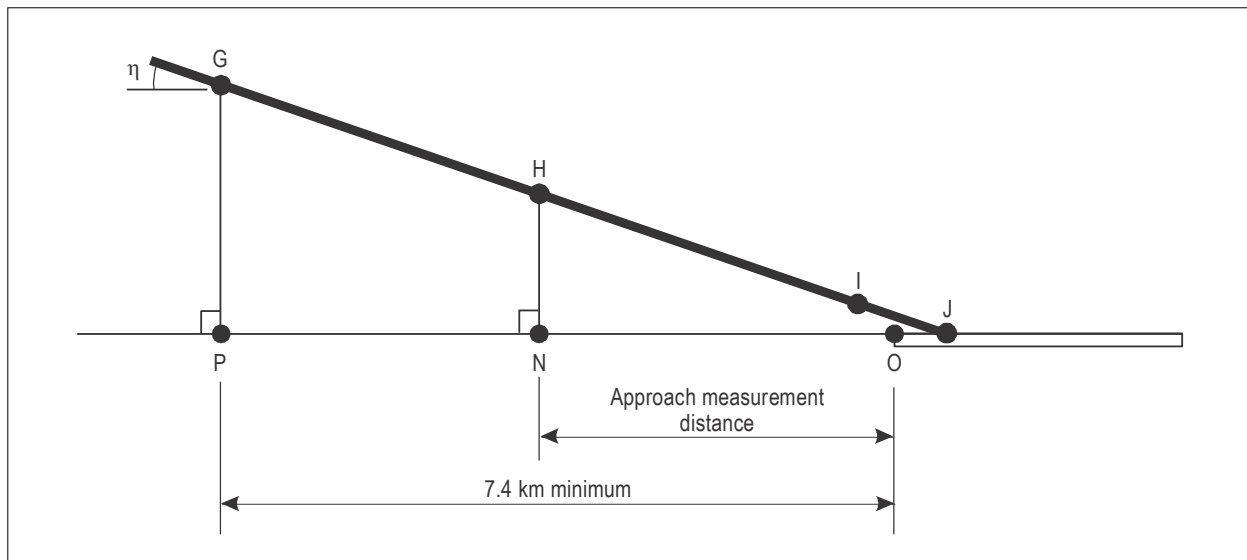

Figure A1-7. Measured approach profile



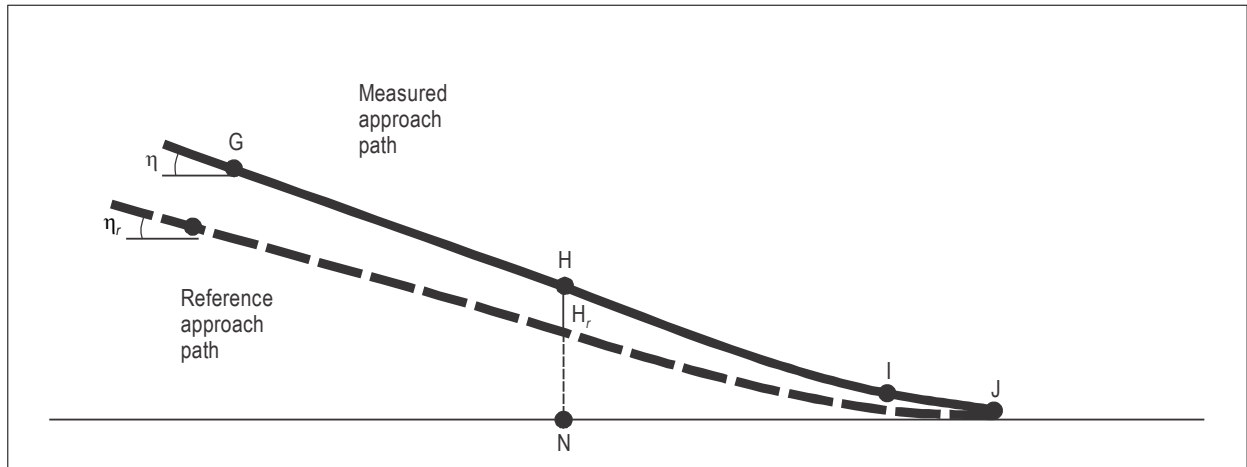

Figure A1-8. Comparison of measured and corrected approach profile

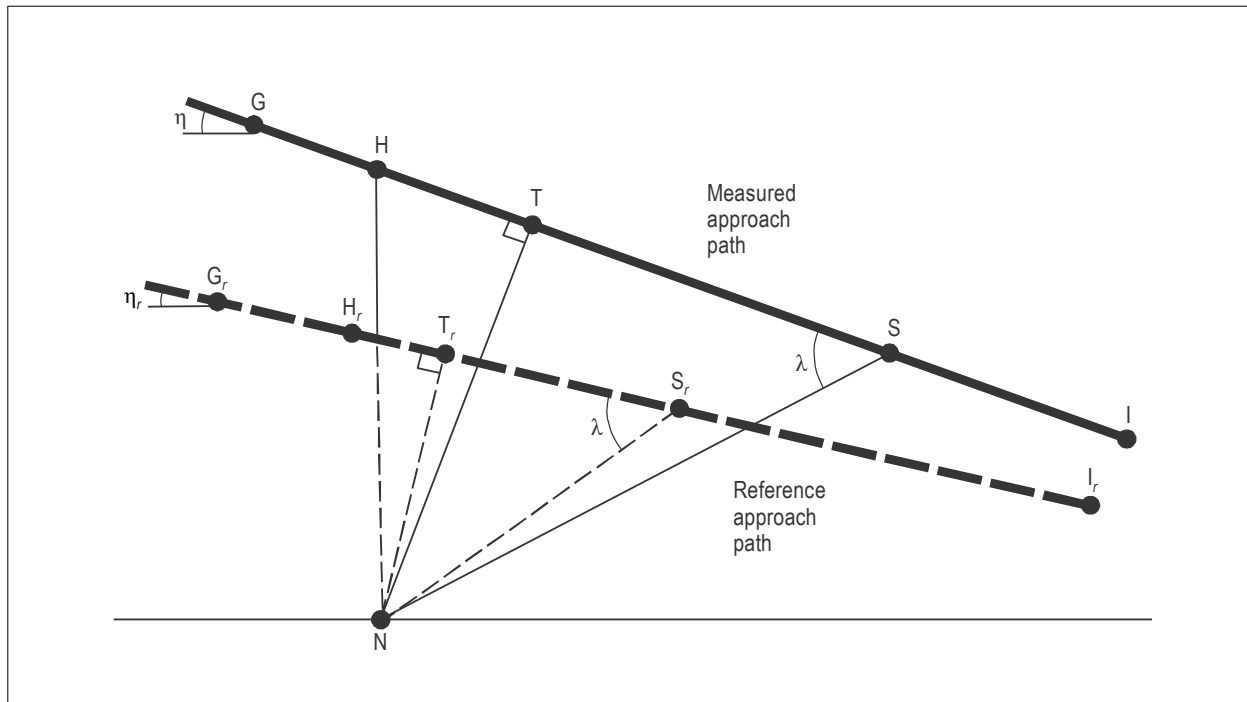

Figure A1-9. Approach profile characteristics influencing sound level

#### 9.4.1.1 Take-off

9.4.1.1.1 Referring to a typical take-off flight path shown in Figure A1-6, the spectrum of PNLTM observed at station K, for the aeroplane at position Q, shall be decomposed into its individual SPL(*i*) values. A set of corrected values shall be computed as follows:

$$\text{SPL}(i)_c = \text{SPL}(i) + 0.01[\alpha(i) - \alpha(i)_o] \text{KQ} + 0.01 \alpha(i)_o (\text{KQ} - \text{KQ}_c) + 20 \log (\text{KQ}/\text{KQ}_c)$$

- the term  $0.01 [\alpha(i) - \alpha(i)_o] \text{KQ}$  accounts for the effects of the change in atmospheric sound absorption where  $\alpha(i)$  and  $\alpha(i)_o$  are the sound absorption coefficients for the test and reference conditions respectively for the *i*-th one-third octave band and KQ is the measured take-off noise path;
- the term  $0.01 \alpha(i)_o (\text{KQ} - \text{KQ}_c)$  accounts for the effect of atmospheric sound absorption on the change in the noise path length, where  $\text{KQ}_c$  is the corrected take-off noise path; and
- the term  $20 \log (\text{KQ}/\text{KQ}_c)$  accounts for the effects of the inverse square law on the change in the noise path length.

9.4.1.1.2 The corrected values of SPL(*i*)<sub>c</sub> shall then be converted to PNLT and a correction term calculated as follows:

$$\Delta_1 = \text{PNLT} - \text{PNLTM}$$

which represents the correction to be added algebraically to the EPNL calculated from the measured data.

#### 9.4.1.2 Approach

The same procedure shall be used for the approach flight path except that the values for SPL(*i*)<sub>c</sub> relate to the approach noise paths shown in Figure A1-9 as follows:

$$\text{SPL}(i)_c = \text{SPL}(i) + 0.01 [\alpha(i) - \alpha(i)_o] \text{NS} + 0.01 \alpha(i)_o (\text{NS} - \text{NS}_r) + 20 \log (\text{NS}/\text{NS}_r)$$

where NS and NS<sub>r</sub> are the measured and reference approach noise paths, respectively. The remainder of the procedure shall be the same as for the take-off flight path.

#### 9.4.1.3 Lateral

The same procedure shall be used for the lateral flight path except that the values for SPL(*i*)<sub>c</sub> relate only to the measured lateral noise path as follows:

$$\text{SPL}(i)_c = \text{SPL}(i) + 0.01 [\alpha(i) - \alpha(i)_o] \text{LX}$$

where LX shall be the measured lateral noise path from station L (Figure A1-4) to position X of the aeroplane for which PNLTM is observed at station L. Only the correction term accounting for the effects of change in atmospheric sound absorption shall be considered. The difference between the measured and corrected noise path lengths shall be assumed negligible for the lateral flight path. The remainder of the procedure shall be the same as for the take-off flight path.

## 9.5 Duration correction

9.5.1 Whenever the measured take-off and approach flight paths differ from the corrected and reference flight paths, respectively, duration corrections to the EPNL values calculated from the measured data shall be applied. These corrections shall be calculated as described below:

### 9.5.1.1 Take-off

Referring to the take-off flight path shown in Figure A1-6, a correction term shall be calculated as follows:

$$\Delta_2 = -7.5 \log (KR/KR_c)$$

which represents the corrections to be added algebraically to the EPNL calculated from the measured data. The lengths KR and  $KR_c$  shall be the measured and corrected take-off minimum distances, respectively, from the noise measuring station K to the measured and corrected flight paths. The negative sign shall indicate that, for the particular case of a duration correction, the EPNL calculated from the measured data shall be reduced if the measured flight path is at a greater altitude than the corrected flight path.

### 9.5.1.2 Approach

The same procedure shall be used for the approach flight path except that the correction relates to the approach minimum distances shown in Figure A1-9 as follows:

$$\Delta_2 = -7.5 \log (NT/NT_r)$$

where NT is the measured approach minimum distance from the noise measuring station N to the measured flight path.

### 9.5.1.3 Lateral

No duration correction shall be computed for the lateral flight path because the differences between the measured and corrected flight paths are assumed negligible.

## 9.6 Mass correction

Whenever the aeroplane mass, during either the noise certification take-off or approach test, is different from the corresponding maximum take-off or landing mass, a correction shall be applied to the EPNL value calculated from the measured data. The corrections shall be determined from the manufacturer's data (approved by the certifying authority) in the form of tables or curves such as schematically indicated in Figures A1-10 and A1-11. The manufacturer's data shall be applicable to the noise certification reference atmospheric conditions.

## 9.7 Approach angle correction

Whenever the aeroplane approach angle during the noise certification approach test is different from the reference approach angle, a correction shall be applied to the EPNL value calculated from the measured data. The corrections shall be determined from the manufacturer's data (approved by the certifying authority) in the form of tables or curves such as schematically indicated in Figure A1-12. The manufacturer's data shall be applicable to the noise certification reference atmospheric conditions and to the test landing mass.

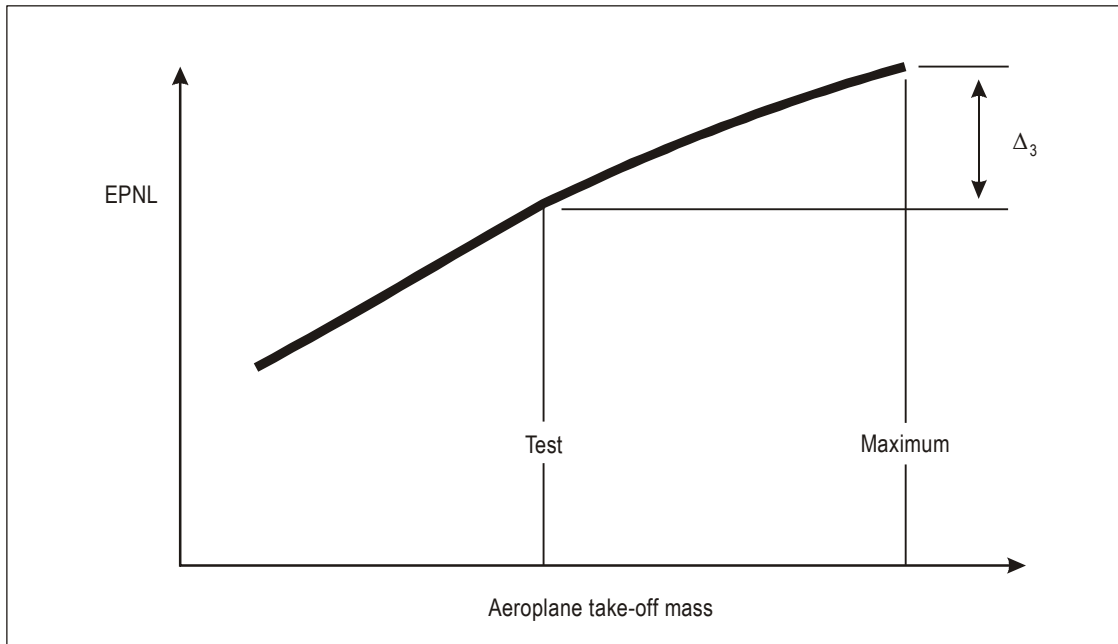

Figure A1-10. Take-off mass correction for EPNL

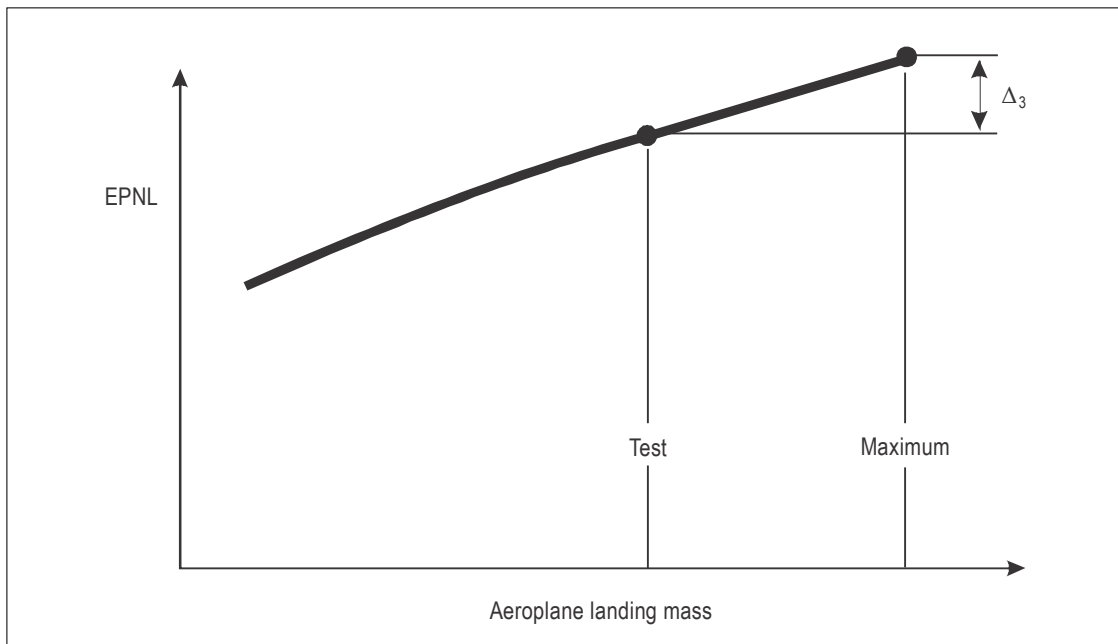

Figure A1-11. Approach mass correction for EPNL

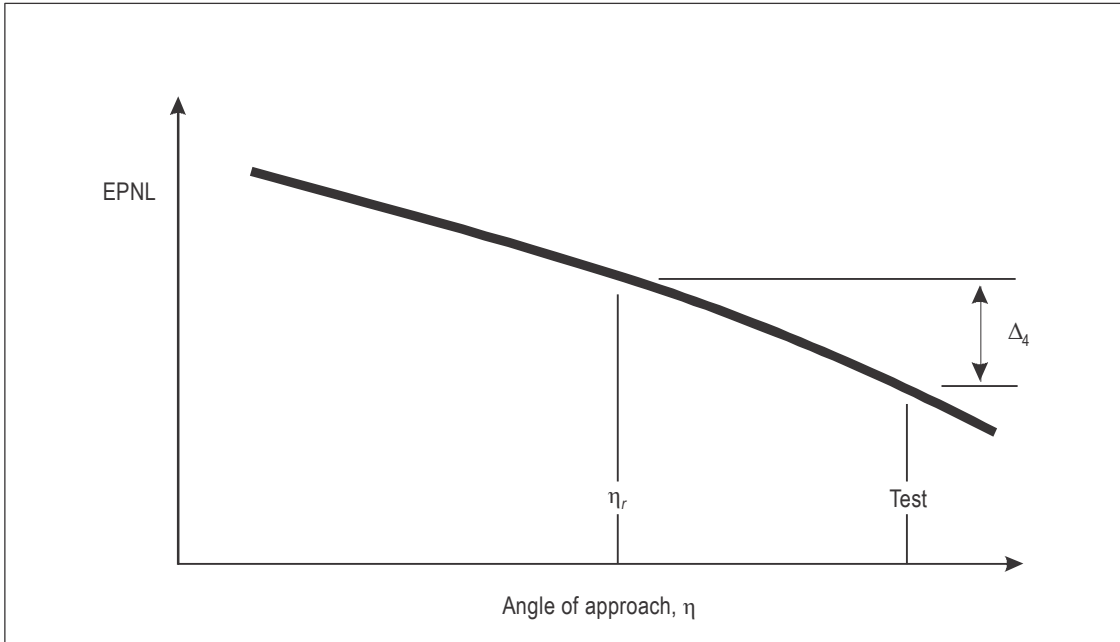

Figure A1-12. Approach angle correction for EPNL



## **APPENDIX 2. EVALUATION METHOD FOR NOISE CERTIFICATION OF:**

- 1.— SUBSONIC JET AEROPLANES — Application for  
Type Certificate submitted on or after 6 October 1977**
- 2.— PROPELLER-DRIVEN AEROPLANES OVER 8 618 kg —  
Application for Type Certificate submitted on or after  
1 January 1985**
- 3.— HELICOPTERS**
- 4.— TILT-ROTORs**

*Note.— See Part II, Chapters 3, 4, 8, 13 and 14.*

### **1. INTRODUCTION**

*Note 1.— This noise evaluation method includes:*

- a) noise certification test and measurement conditions;*
- b) measurement of aeroplane and helicopter noise received on the ground;*
- c) calculation of effective perceived noise level from measured noise data; and*
- d) reporting of data to the certifying authority and correcting measured data.*

*Note 2.— The instructions and procedures given in the method are clearly delineated to ensure uniformity during compliance tests, and to permit comparison between tests of various types of aircraft conducted in various geographical locations.*

*Note 3.— A complete list of symbols and units is included in Part I of this Annex. The mathematical formulation of perceived noisiness, a procedure for determining atmospheric attenuation of sound, and detailed procedures for correcting noise levels from non-reference to reference conditions are included in Sections 7 and 8 of this appendix.*

### **2. NOISE CERTIFICATION TEST AND MEASUREMENT CONDITIONS**

#### **2.1 General**

This section prescribes the conditions under which noise certification tests shall be conducted and the measurement procedures that shall be used.

*Note.*— Many applications for a noise certificate involve only minor changes to the aircraft type design. The resultant changes in noise can often be established reliably without the necessity of resorting to a complete test as outlined in this appendix. For this reason certificating authorities are encouraged to permit the use of appropriate “equivalent procedures”. Also, there are equivalent procedures that may be used in full certification tests, in the interest of reducing costs and providing reliable results. Guidance material on the use of equivalent procedures in the noise certification of subsonic jet and propeller-driven aeroplanes and helicopters is provided in the Environmental Technical Manual (Doc 9501), Volume I — Procedures for the Noise Certification of Aircraft.

## 2.2 Test environment

### 2.2.1 Microphone locations

Locations for measuring noise from an aircraft in flight shall be surrounded by relatively flat terrain having no excessive sound absorption characteristics such as might be caused by thick, matted, or tall grass, shrubs, or wooded areas. No obstructions which significantly influence the sound field from the aircraft shall exist within a conical space above the point on the ground vertically below the microphone, the cone being defined by an axis normal to the ground and by a half-angle  $80^\circ$  from this axis.

*Note.*— Those people carrying out the measurements could themselves constitute such obstructions.

### 2.2.2 Atmospheric conditions

#### 2.2.2.1 Definitions and specifications

For the purposes of noise certification in this section the following specifications apply:

**Average crosswind component** shall be determined from the series of individual values of the “cross-track” (v) component of the wind samples obtained during the aircraft test run, using a linear averaging process over 30 seconds or an averaging process that has a time constant of no more than 30 seconds, the result of which is read out at a moment approximately 15 seconds after the time at which the aircraft flight path intercepts the vertical geometrical plane perpendicular to the reference ground track at the centre microphone.

*Note.*— The reference ground track is defined in 8.1.3.5.

**Average wind speed** shall be determined from the series of individual wind speed samples obtained during the aircraft test run, using a linear averaging process over 30 seconds, or an averaging process that has a time constant of no more than 30 seconds, the result of which is read out at a moment approximately 15 seconds after the time at which the aircraft flight path intercepts the vertical geometrical plane perpendicular to the reference ground track at the centre microphone. Alternatively, each wind vector shall be broken down into its “along-track” (u) and “cross-track” (v) components. The u and v components of the series of individual wind samples obtained during the aircraft test run shall be separately averaged using a linear averaging process over 30 seconds, or an averaging process that has a time constant of no more than 30 seconds, the result of which is read out at a moment approximately 15 seconds after the time at which the aircraft flight path intercepts the vertical geometrical plane perpendicular to the reference ground track at the centre microphone. The average wind speed and direction (with respect to the track) shall then be calculated from the averaged u and v components according to Pythagorean Theorem and “ $\arctan(v/u)$ ”.

**Distance constant (or response length).** The passage of wind (in metres) required for the output of a wind speed sensor to indicate  $100 \times (1-1/e)$  per cent (about 63 per cent) of a step-function increase of the input speed.

**Maximum crosswind component.** The maximum value within the series of individual values of the “cross-track” (v) component of the wind samples recorded every second over a time interval that spans the 10 dB-down period.



**Maximum wind speed.** The maximum value within the series of individual wind speed samples recorded every second over a time interval that spans the 10 dB-down period.

**Sound attenuation coefficient.** The reduction in level of sound within a one-third octave band, in dB per 100 metres, due to the effects of atmospheric absorption of sound. Equations for the calculation of sound attenuation coefficients from values of atmospheric temperature and relative humidity are provided in Section 7.

**Time constant (of a first order system).** The time required for a device to detect and indicate  $100 \times (1-1/e)$  per cent (about 63 per cent) of a step function change. (The mathematical constant,  $e$ , is the base number of the natural logarithm, approximately 2.7183 — also known as Euler’s number, or Napier’s constant.)

**Wind direction sample (at a certain moment).** The value obtained at that moment from a wind direction sensor/system with characteristics as follows:

Wind speed operating range:	1 m/s (2 kt) to more than 10 m/s (20 kt);
Linearity:	$\pm 5$ degrees over the specified range; and
Resolution:	5 degrees.

*Note.*— For the entire wind sensing system used to obtain wind speed and direction samples, the combined dynamic characteristics, including physical inertia of the sensor(s), and any temporal processing, such as filtering of the sensor signal(s), or smoothing or averaging of the wind sensor data, shall be equivalent to a first order system (such as an R/C circuit) with a time constant of no greater than 3 seconds at a wind speed of 5 m/s (10 kt).

**Wind speed sample (at a certain moment).** The value measured at that moment for wind speed using a sensor/system with characteristics as follows:

Range:	1 m/s (2 kt) to more than 10 m/s (20 kt);
Linearity:	$\pm 0.5$ m/s ( $\pm 1$ kt) over the specified range; and
Distance constant (response length):	less than 5 metres for systems having dynamic behaviour best characterized by a distance constant; or
Time constant:	less than 3 seconds for wind speeds at or above 5 m/s (10 kt) for systems having dynamic behaviour best characterized by a time constant.

**Wind vector (at a certain moment).** At least once every second the wind vector shall be determined. Its magnitude will be represented at a certain moment by the wind speed sample at that moment and the direction of the vector shall be represented by the wind direction sample at that moment.

### 2.2.2.2 Measurement

2.2.2.2.1 Measurements of the ambient temperature and relative humidity shall be made at 10 m (33 ft) above the ground. For aeroplanes the ambient temperature and relative humidity shall also be determined at vertical increments not greater than 30 m (100 ft) over the sound propagation path. For an aircraft test run to be acceptable, measurements of ambient temperature and relative humidity shall be obtained before and after the test run. Both measurements shall be representative of the prevailing conditions during the test run and at least one of the measurements of ambient temperature and relative humidity shall be within 30 minutes of the test run. The temperature and relative humidity data at the actual time of the test run shall be interpolated over time and height, as necessary, from the measured meteorological data.

*Note.*— The temperature and relative humidity measured at 10 m (33 ft) are assumed to be constant from 10 m (33 ft) to the ground.

2.2.2.2.2 Measurements of wind speed and direction shall be made at 10 m (33 ft) above the ground throughout each test run.

2.2.2.2.3 The meteorological conditions at 10 m above the ground shall be measured within 2 000 m (6 562 ft) of the microphone locations. They shall be representative of the conditions existing over the geographical area in which noise measurements are made.

#### 2.2.2.3 Instrumentation

2.2.2.3.1 Instrumentation for the measurement of temperature and humidity between the ground and the aeroplane, including instrumentation for the determination of the height at which these measurements are made, and the manner in which such instrumentation is used shall, to the satisfaction of the certificating authority, enable the sampling of atmospheric conditions at 30 m (100 ft) vertical height increments or less.

2.2.2.3.2 All wind speed samples shall be taken with the sensor installed such that the horizontal distance between the anemometer and any obstruction is at least 10 times the height of the obstruction. Installation error for the wind direction sensor shall be no greater than 5 degrees.

2.2.2.3.3 The instrumentation for noise and meteorological measuring and aircraft flight path tracking shall be operated within the environmental limitations specified by the manufacturer.

#### 2.2.2.4 Test window

2.2.2.4.1 For aircraft test runs to be acceptable, they shall be carried out under the following atmospheric conditions, except as provided in 2.2.2.4.2:

- a) there shall be no precipitation;
- b) the ambient air temperature shall not be greater than 35°C and shall not be less than -10°C over the sound propagation path between a point 10 m (33 ft) above the ground and the aircraft;
- c) the relative humidity shall not be greater than 95 per cent and shall not be less than 20 per cent over the sound propagation path between a point 10 m (33 ft) above the ground and the aircraft;
- d) the sound attenuation coefficient in the 8 kHz one-third octave band shall not be more than 12 dB/100 m over the sound propagation path between a point 10 m (33 ft) above the ground and the height of the aircraft at PNLTM;

*Note.— Section 7 of this appendix specifies the method for calculation of sound attenuation coefficients based on temperature and humidity.*

- e) for aeroplanes the average wind speed at 10 m (33 ft) above the ground shall not exceed 6.2 m/s (12 kt) and the maximum wind speed at 10 m (33 ft) above the ground shall not exceed 7.7 m/s (15 kt);
- f) for aeroplanes the average crosswind component at 10 m (33 ft) above the ground shall not exceed 3.6 m/s (7 kt) and the maximum crosswind component at 10 m (33 ft) above the ground shall not exceed 5.1 m/s (10 kt);
- g) for helicopters the average wind speed at 10 m (33 ft) above the ground shall not exceed 5.1 m/s (10 kt);
- h) for helicopters the average crosswind component at 10 m (33 ft) above the ground shall not exceed 2.6 m/s (5 kt);  
and
- i) there shall be no anomalous meteorological or wind conditions that would significantly affect the measured noise levels.

*Note.*— The noise certification test windows for wind speed expressed in m/s are the result of converting historically used values expressed in knots using a conversion factor consistent with Annex 5, Chapter 3, Table 3-3, and rounded to 0.1 m/s. The values as given here, expressed in either unit, are considered equivalent for establishing adherence to the wind speed test windows for noise certification purposes.

2.2.2.4.2 For helicopters the requirements of 2.2.2.4.1 b), c) and d) shall only apply at 10 m (33 ft) above the ground.

### 2.2.2.5 Layering

2.2.2.5.1 For each aeroplane test run the sound attenuation coefficient in the 3 150 Hz one-third octave band shall be determined at the time of PNLTM from 10 m (33 ft) above the ground to the height of the aeroplane, with vertical height increments not greater than 30 m (100 ft).

2.2.2.5.2 If the individual values of the sound attenuation coefficient in the 3 150 Hz one-third octave band associated with the vertical height increments specified in 2.2.2.5.1 do not vary by more than 0.5 dB/100 m relative to the value determined at 10 m (33 ft), the coefficient to be used in the adjustment of the aeroplane noise levels for each one-third octave band shall be the average of the coefficient calculated from the temperature and humidity at 10 m (33 ft) above the ground and the coefficient calculated from the temperature and humidity at the height of the test aeroplane.

2.2.2.5.3 If the individual values of the sound attenuation coefficient in the 3 150 Hz one-third octave band associated with the vertical height increments specified in 2.2.2.5.1 vary by more than 0.5 dB/100 m relative to the value determined at 10 m (33 ft), then “layered” sections of the atmosphere shall be used, as described below, in the computation of the coefficient for each one-third octave band to be used in the adjustment of the aeroplane noise levels:

- a) the atmosphere from the ground to at least the height of the aeroplane shall be divided into layers of 30 m (100 ft) depth;
- b) for each of the layers specified in 2.2.2.5.3 a), the sound attenuation coefficient shall be determined for each one-third octave band; and
- c) for each one-third octave band the sound attenuation coefficient to be used in the adjustment of the aeroplane noise levels shall be the average of the individual layer coefficients specified in 2.2.2.5.3 b).

2.2.2.5.4 For helicopters, the sound attenuation coefficient to be used in the adjustment of noise levels for each one-third octave band shall be calculated from the temperature and humidity at 10 m (33 ft) above the ground.

## 2.3 Flight path measurement

2.3.1 The aircraft spatial position relative to the measurement microphone(s) shall be determined by a method which is approved by the certifying authority and is independent of cockpit flight instrumentation.

*Note.*— Guidance material on aircraft position measurement systems is provided in the Environmental Technical Manual (Doc 9501), Volume I— Procedures for the Noise Certification of Aircraft.

2.3.2 The aircraft position along the flight path shall be synchronized to the noise recorded at the noise measurement locations by means of time-synchronizing signals over a distance and duration sufficient to assure that adequate data is obtained during the period that the noise is within 10 dB of the maximum value of PNLT.

2.3.3 Position and performance data required to make the adjustments referred to in Section 8 of this appendix shall be automatically recorded at an approved sampling rate. Measuring equipment shall be approved by the certifying authority.

### 3. MEASUREMENT OF AIRCRAFT NOISE RECEIVED ON THE GROUND

#### 3.1 Definitions

For the purposes of this section the following definitions apply:

**Ambient noise.** The acoustical noise from sources other than the test aircraft present at the microphone site during aircraft noise measurement. Ambient noise is one component of background noise.

**Background noise.** The combined noise present in a measurement system from sources other than the test aircraft, which can influence or obscure the aircraft noise levels being measured. Typical elements of background noise include (but are not limited to): ambient noise from sources around the microphone site; thermal electrical noise generated by components in the measurement system; magnetic flux noise (“tape hiss”) from analogue tape recorders; and digitization noise caused by quantization error in digital converters. Some elements of background noise, such as digitization noise, can obscure the aircraft noise signal, while others, such as ambient noise, can also contribute energy to the measured aircraft noise signal.

**Broadband noise.** Noise for which the frequency spectrum is continuous (i.e. energy is present at all frequencies in a given range) and which lacks any discrete frequency components (i.e. tones).

**Calibration check frequency.** In hertz, the nominal frequency of the sinusoidal sound pressure signal produced by the sound calibrator.

**Calibration sound pressure level.** In decibels, the sound pressure level produced, under reference environmental conditions, in the cavity of the coupler of the sound calibrator that is used to determine the overall acoustical sensitivity of a measurement system.

**Free-field sensitivity level of a microphone system.** In decibels, twenty times the logarithm to the base ten of the ratio of the free-field sensitivity of a microphone system and the reference sensitivity of one volt per pascal.

*Note.— The free-field sensitivity level of a microphone system may be determined by subtracting the sound pressure level (in decibels re 20  $\mu$ Pa) of the sound incident on the microphone from the voltage level (in decibels re 1 V) at the output of the microphone system, and adding 93.98 dB to the result.*

**Free-field sensitivity of a microphone system.** In volts per pascal, for a sinusoidal plane progressive sound wave of specified frequency, at a specified sound-incidence angle, the quotient of the root-mean-square voltage at the output of a microphone system and the root-mean-square sound pressure that would exist at the position of the microphone in its absence.

**Level difference.** In decibels, for any nominal one-third octave midband frequency, the output signal level measured on any level range minus the level of the corresponding electrical input signal.

**Level non-linearity.** In decibels, the level difference measured on any level range, at a stated one-third octave nominal midband frequency, minus the corresponding reference level difference, all input and output signals being relative to the same reference quantity.

**Level range.** In decibels, an operating range determined by the setting of the controls that are provided in a measurement system for the recording and one-third octave band analysis of a sound pressure signal. The upper boundary associated with any particular level range shall be rounded to the nearest decibel.

**Linear operating range.** In decibels, for a stated level range and frequency, the range of levels of steady sinusoidal electrical signals applied to the input of the entire measurement system, exclusive of the microphone but including the microphone preamplifier and any other signal-conditioning elements that are considered to be part of the microphone system, extending from a lower to an upper boundary, over which the level non-linearity is within specified tolerance limits.

*Note.— It is not necessary to include microphone extension cables as configured in the field.*

**Measurement system.** The combination of instruments used for the measurement of sound pressure levels, including a sound calibrator, windscreen, microphone system, signal recording and conditioning devices, and a one-third octave band analysis system.

*Note.— Practical installations may include a number of microphone systems, the outputs from which are recorded simultaneously by a multi-channel recording/analysis device via signal conditioners as appropriate. For the purpose of this section, each complete measurement channel is considered to be a measurement system to which the requirements apply accordingly.*

**Microphone system.** The components of the measurement system which produce an electrical output signal in response to a sound pressure input signal, and which generally include a microphone, a preamplifier, extension cables, and other devices as necessary.

**Reference direction.** In degrees, the direction of sound incidence specified by the manufacturer of the microphone, relative to a sound incidence angle of 0°, for which the free-field sensitivity level of the microphone system is within specified tolerance limits.

**Reference level difference.** In decibels, for a stated frequency, the level difference measured on a level range for an electrical input signal corresponding to the calibration sound pressure level, adjusted as appropriate, for the level range.

**Reference level range.** In decibels, the level range for determining the acoustical sensitivity of the measurement system and containing the calibration sound pressure level.

**Sound incidence angle.** In degrees, an angle between the principal axis of the microphone and a line from the sound source to the centre of the diaphragm of the microphone.

*Note.— When the sound incidence angle is 0°, the sound is said to be received at the microphone at “normal (perpendicular) incidence”; when the sound incidence angle is 90°, the sound is said to be received at “grazing incidence”. The principal axis of a measurement microphone is through the centre of the diaphragm and perpendicular to it.*

**Time-average band sound pressure level.** In decibels, ten times the logarithm to the base ten, of the ratio of the time mean-square of the instantaneous sound pressure during a stated time interval and in a specified one-third octave band, to the square of the reference sound pressure of 20 µPa.

**Windscreen insertion loss.** In decibels, at a stated nominal one-third octave midband frequency, and for a stated sound incidence angle on the inserted microphone, the indicated sound pressure level without the windscreen installed around the microphone minus the sound pressure level with the windscreen installed.

### 3.2 Reference environmental conditions

The reference environmental conditions for specifying the performance of a measurement system are:

- air temperature            23°C
- static air pressure        101.325 kPa
- relative humidity         50 per cent.

### 3.3 General

*Note.— Measurements of aircraft noise that utilize instruments that conform to the specifications of this section yield one-third octave band sound pressure levels as a function of time, for the calculation of the effective perceived noise level as described in Section 4.*

3.3.1 The measurement system shall consist of equipment approved by the certificating authority and equivalent to the following:

- a) a windscreen (see 3.4);
- b) a microphone system (see 3.5);
- c) a recording and reproducing system to store the measured aircraft noise signals for subsequent analysis (see 3.6);
- d) a one-third octave band analysis system (see 3.7); and
- e) calibration systems to maintain the acoustical sensitivity of the above systems within specified tolerance limits (see 3.8).

3.3.2 For any component of the measurement system that converts an analogue signal to digital form, such conversion shall be performed so that the levels of any possible aliases or artefacts of the digitization process will be less than the upper boundary of the linear operating range by at least 50 dB at any frequency less than 12.5 kHz. The sampling rate shall be at least 28 kHz. An anti-aliasing filter shall be included before the digitization process.

### 3.4 Windscreen

In the absence of wind and for sinusoidal sounds at grazing incidence, the insertion loss caused by the windscreen of a stated type installed around the microphone shall not exceed  $\pm 1.5$  dB at nominal one-third octave midband frequencies from 50 Hz to 10 kHz inclusive.

### 3.5 Microphone system

3.5.1 The microphone system shall conform to the specifications in 3.5.2 to 3.5.4. Various microphone systems may be approved by the certificating authority on the basis of demonstrated equivalent overall electroacoustical performance. Where two or more microphone systems of the same type are used, demonstration that at least one system conforms to the specifications in full is sufficient to demonstrate conformance.

*Note.*— This demonstration of equivalent performance does not eliminate the need to calibrate and check each system as defined in 3.9.

3.5.2 The microphone shall be mounted with the sensing element 1.2 m (4 ft) above the local ground surface and shall be oriented for grazing incidence, i.e. with the sensing element substantially in the plane defined by the predicted reference flight path of the aircraft and the measuring station. The microphone mounting arrangement shall minimize the interference of the supports with the sound to be measured. Figure A2-1 illustrates sound incidence angles on a microphone.

3.5.3 The free-field sensitivity level of the microphone and preamplifier in the reference direction, at frequencies over at least the range of one-third octave nominal midband frequencies from 50 Hz to 5 kHz inclusive, shall be within  $\pm 1.0$  dB of that at the calibration check frequency, and within  $\pm 2.0$  dB for nominal midband frequencies of 6.3 kHz, 8 kHz and 10 kHz.

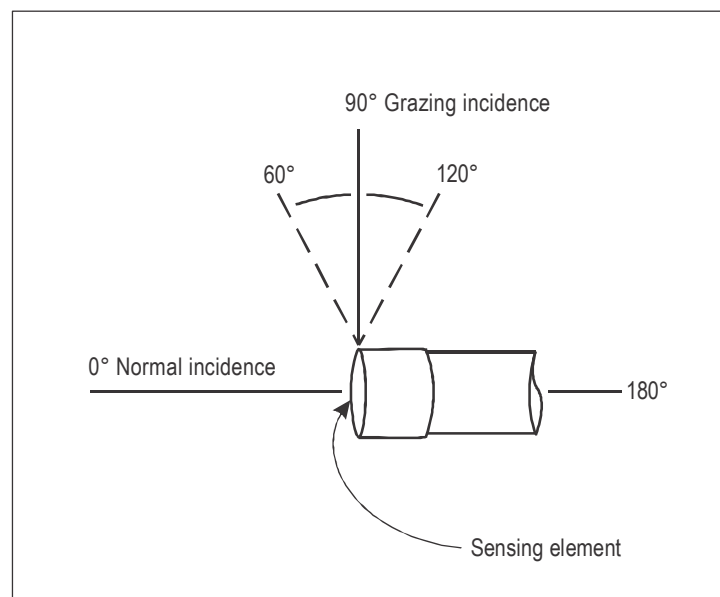

**Figure A2-1. Illustration of sound incidence angles on a microphone**

3.5.4 For sinusoidal sound waves at each one-third octave nominal midband frequency over the range from 50 Hz to 10 kHz inclusive, the free-field sensitivity levels of the microphone system at sound incidence angles of 30°, 60°, 90°, 120° and 150° shall not differ from the free-field sensitivity level at a sound incidence angle of 0° (“normal incidence”) by more than the values shown in Table A2-1. The free-field sensitivity level differences at sound incidence angles between any two adjacent sound incidence angles in Table A2-1 shall not exceed the tolerance limit for the greater angle.

**Table A2-1. Microphone directional response requirements**

Nominal midband frequency kHz	Maximum difference between the free-field sensitivity level of a microphone system at normal incidence and the free-field sensitivity level at specified sound incidence angles (dB)				
	Sound incidence angle degrees				
	30	60	90	120	150
0.05 to 1.6	0.5	0.5	1.0	1.0	1.0
2.0	0.5	0.5	1.0	1.0	1.0
2.5	0.5	0.5	1.0	1.5	1.5
3.15	0.5	1.0	1.5	2.0	2.0
4.0	0.5	1.0	2.0	2.5	2.5
5.0	0.5	1.5	2.5	3.0	3.0
6.3	1.0	2.0	3.0	4.0	4.0
8.0	1.5	2.5	4.0	5.5	5.5
10.0	2.0	3.5	5.5	6.5	7.5

### 3.6 Recording and reproducing systems

3.6.1 A recording and reproducing system, such as a digital or analogue magnetic tape recorder, a computer-based system or other permanent data storage device, shall be used to store sound pressure signals for subsequent analysis. The sound produced by the aircraft shall be recorded in such a way that a record of the complete acoustical signal is retained. The recording and reproducing systems shall conform to the specifications in 3.6.2 to 3.6.9 at the recording speeds and/or data sampling rates used for the noise certification tests. Conformance shall be demonstrated for the frequency bandwidths and recording channels selected for the tests.

3.6.2 The recording and reproducing systems shall be calibrated as described in 3.9.

*Note.— For aircraft noise signals for which the high frequency spectral levels decrease rapidly with increasing frequency, appropriate pre-emphasis and complementary de-emphasis networks may be included in the measurement system. If pre-emphasis is included, over the range of nominal one-third octave midband frequencies from 800 Hz to 10 kHz inclusive, the electrical gain provided by the pre-emphasis network shall not exceed 20 dB relative to the gain at 800 Hz.*

3.6.3 For steady sinusoidal electrical signals applied to the input of the entire measurement system exclusive of the microphone system, but including the microphone preamplifier, and any other signal-conditioning elements that are considered to be part of the microphone system, at a selected signal level within 5 dB of that corresponding to the calibration sound pressure level on the reference level range, the time average signal level indicated by the readout device at any one-third octave nominal midband frequency from 50 Hz to 10 kHz inclusive shall be within  $\pm 1.5$  dB of that at the calibration check frequency. The frequency response of a measurement system, which includes components that convert analogue signals to digital form, shall be within  $\pm 0.3$  dB of the response at 10 kHz over the frequency range from 10 kHz to 11.2 kHz.

*Note.— It is not necessary to include microphone extension cables as configured in the field.*



3.6.4 For analogue tape recordings, the amplitude fluctuations of a 1 kHz sinusoidal signal recorded within 5 dB of the level corresponding to the calibration sound pressure level shall not vary by more than  $\pm 0.5$  dB throughout any reel of the type of magnetic tape utilized. Conformance to this requirement shall be demonstrated using a device which has time-averaging properties equivalent to those of the spectrum analyser.

3.6.5 For all appropriate level ranges and for steady sinusoidal electrical signals applied to the input of the measurement system exclusive of the microphone system, but including the microphone preamplifier, and any other signal-conditioning elements that are considered to be part of the microphone system, at one-third octave nominal midband frequencies of 50 Hz, 1 kHz and 10 kHz, and the calibration check frequency, if it is not one of these frequencies, the level non-linearity shall not exceed  $\pm 0.5$  dB for a linear operating range of at least 50 dB below the upper boundary of the level range.

**Recommendation.**— *Level linearity of measurement system components should be tested according to the methods described in IEC 61265<sup>1</sup> as amended.*

*Note.*— *It is not necessary to include microphone extension cables as configured in the field.*

3.6.6 On the reference level range, the level corresponding to the calibration sound pressure level shall be at least 5 dB, but no more than 30 dB less than the upper boundary of the level range.

3.6.7 The linear operating ranges on adjacent level ranges shall overlap by at least 50 dB minus the change in attenuation introduced by a change in the level range controls.

*Note.*— *It is possible for a measurement system to have level range controls that permit attenuation changes of, for example, either 10 dB or 1 dB. With 10 dB steps, the minimum overlap required would be 40 dB, and with 1 dB steps the minimum overlap would be 49 dB.*

3.6.8 Provision shall be made for an overload indication to occur during an overload condition on any relevant level range.

3.6.9 Attenuators included in the measurement system to permit range changes shall operate in known intervals of decibel steps.

### 3.7 Analysis systems

3.7.1 The analysis system shall conform to the specifications in 3.7.2 to 3.7.7 for the frequency bandwidths, channel configurations and gain settings used for analysis.

3.7.2 The output of the analysis system shall consist of one-third octave band sound pressure levels as a function of time, obtained by processing the noise signals (preferably recorded) through an analysis system with the following characteristics:

- a) a set of 24 one-third octave band filters, or their equivalent, having nominal midband frequencies from 50 Hz to 10 kHz inclusive;
- b) response and averaging properties in which, in principle, the output from any one-third octave filter band is squared, averaged and displayed or stored as time-averaged sound pressure levels;

---

1. IEC 61265:1995 entitled “Electroacoustics — Instruments for measurement of aircraft noise — Performance requirements for systems to measure one-third-octave band sound pressure levels in noise certification of transport-category aeroplanes”. This IEC publication may be obtained from the Central Office of the International Electrotechnical Commission, 3 rue de Varembe, Geneva, Switzerland.

- c) the interval between successive sound pressure level samples shall be  $500 \text{ ms} \pm 5 \text{ ms}$  for spectral analysis with or without SLOW-time-weighting;
- d) for those analysis systems that do not process the sound pressure signals during the period of time required for readout and/or resetting of the analyser, the loss of data shall not exceed a duration of 5 ms; and
- e) the analysis system shall operate in real time from 50 Hz to at least 12 kHz inclusive. This requirement applies to all operating channels of a multichannel spectral analysis system.

3.7.3 The one-third octave band analysis system shall conform to the class 1 performance requirements of IEC 61260-1<sup>2</sup> as amended, over the range of one-third octave filters having nominal midband frequencies from 50 Hz to 10 kHz inclusive.

*Note.*— The certifying authority may allow the substitution of an analysis system that complies with class 2 performance requirements of IEC 61260-1<sup>2</sup> or with class 1 or class 2 of an earlier version of IEC 61260.

**Recommendation.**—Tests of the one-third octave band analysis system should be made according to the methods described in IEC 61260-3<sup>3</sup> or by an equivalent procedure approved by the certifying authority, for relative attenuation, anti-aliasing filters, real-time operation, level linearity, and filter integrated response (effective bandwidth).

3.7.4 When SLOW-time-averaging is performed in the analyser, the response of the one-third octave band analysis system to a sudden onset or interruption of a constant sinusoidal signal at the respective one-third octave nominal midband frequency shall be measured at sampling instants 0.5, 1, 1.5 and 2 seconds after both the onset and the interruption. The rising response shall be  $-4 \pm 1 \text{ dB}$  at 0.5 seconds,  $-1.75 \pm 0.75 \text{ dB}$  at 1 second,  $-1 \pm 0.5 \text{ dB}$  at 1.5 seconds and  $-0.5 \pm 0.5 \text{ dB}$  at 2 seconds relative to the steady-state level. The sum of the rising and corresponding falling shall be  $-6.5 \pm 1 \text{ dB}$ , at both 0.5 and 1 seconds. The sum of the rising and falling responses shall be  $-6.5 \text{ dB}$  or less at 1.5 seconds and  $-7.5 \text{ dB}$  or less at 2 seconds, and subsequent times relative to the steady-state levels. This equates to an exponential averaging process (SLOW weighting) with a nominal 1-second time constant.

3.7.5 When the one-third octave band sound pressure levels are determined from the output of the analyser without SLOW-time-weighting, SLOW-time-weighting shall be simulated in the subsequent processing. Simulated SLOW-weighted sound pressure levels can be obtained using a continuous exponential averaging process by the following equation:

$$\text{SPL}_s(i,k) = 10 \log [(0.60653) 10^{0.1\text{SPL}_s[i,(k-1)]} + (0.39347) 10^{0.1\text{SPL}(i,k)}]$$

where  $\text{SPL}_s(i,k)$  is the simulated SLOW-weighted sound pressure level and  $\text{SPL}(i,k)$  is the as-measured 0.5 seconds time average sound pressure level determined from the output of the analyser for the  $k$ -th instant of time and the  $i$ -th one-third octave band. For  $k = 1$ , the SLOW-weighted sound pressure  $\text{SPL}_s[i,(k-1 = 0)]$  on the right-hand side shall be set to 0 dB.

An approximation of the continuous exponential averaging is represented by the following equation for a four sample averaging process for  $k = 4$ :

$$\text{SPL}_s(i,k) = 10 \log [(0.13) 10^{0.1\text{SPL}[i,(k-3)]} + (0.21) 10^{0.1\text{SPL}[i,(k-2)]} + (0.27) 10^{0.1\text{SPL}[i,(k-1)]} + (0.39) 10^{0.1\text{SPL}[i,k]}]$$

where  $\text{SPL}_s(i,k)$  is the simulated SLOW-weighted sound pressure level and  $\text{SPL}(i,k)$  is the as-measured 0.5 seconds time average sound pressure level determined from the output of the analyser for the  $k$ -th instant of time and the  $i$ -th one-third octave band.

2. IEC 61260-1:2014 entitled “Electroacoustics — Octave-band and fractional-octave-band filters — Part 1: Specifications”. This IEC publication may be obtained from the Central Office of the International Electrotechnical Commission, 3 rue de Varembe, Geneva, Switzerland.

3. IEC 61260-3:2016 entitled “Electroacoustics — Octave-band and fractional-octave-band filters — Part 3: Periodic tests”. This IEC publication may be obtained from the Central Office of the International Electrotechnical Commission, 3 rue de Varembe, Geneva, Switzerland.

The sum of the weighting factors is 1.0 in the two equations. Sound pressure levels calculated by means of either equation are valid for the sixth and subsequent 0.5 seconds data samples, or for times greater than 2.5 seconds after initiation of data analysis.

*Note.— The coefficients in the two equations were calculated for use in determining equivalent SLOW-weighted sound pressure levels from samples of 0.5 seconds time average sound pressure levels. The equations should not be used with data samples where the averaging time differs from 0.5 seconds.*

3.7.6 The instant in time by which a SLOW-time-weighted sound pressure level is characterized shall be 0.75 seconds earlier than the actual readout time.

*Note.— The definition of this instant in time is required to correlate the recorded noise with the aircraft position when the noise was emitted and takes into account the averaging period of the SLOW weighting. For each one-half second data record this instant in time may also be identified as 1.25 seconds after the start of the associated 2-second averaging period.*

3.7.7 The resolution of the sound pressure levels, both displayed and stored, shall be 0.1 dB or better.

### 3.8 Calibration instrumentation

3.8.1 All instrumentation used for calibration and determination of corrections shall be approved by the certificating authority.

3.8.2 The sound calibrator shall at least conform to the class 1 requirements of IEC 60942.<sup>4</sup> The sound pressure level produced in the cavity of the coupler of the sound calibrator shall be calculated for the test environmental conditions using the manufacturer's supplied information on the influence of atmospheric air pressure and temperature. The output of the sound calibrator shall be determined within six months of each aircraft noise measurement by a method traceable to a national standards laboratory. Tolerable changes in output from the previous calibration shall be not more than 0.2 dB.

3.8.3 If pink noise is used to determine the corrections for system frequency response in 3.9.7, then the output of the noise generator shall be determined within six months of each aircraft noise measurement by a method traceable to a national standards laboratory. Tolerable changes in the relative output from the previous calibration in each one-third octave band shall be not more than 0.2 dB.

### 3.9 Calibration and checking of system

3.9.1 Calibration and checking of the measurement system and its constituent components shall be carried out to the satisfaction of the certificating authority by the methods specified in 3.9.2 to 3.9.9. All calibration corrections and adjustments, including those for the environmental effects on sound calibrator output level, shall be reported to the certificating authority and applied to the measured one third octave sound pressure levels determined from the output of the analyser. Aircraft noise data collected during an overload condition of any measurement system components in the signal path prior to and including the recorder are invalid and shall not be used. If the overload condition occurred during analysis or at a point in the signal path after the recorder, the analysis shall be repeated with reduced sensitivity to eliminate the overload.

3.9.2 The acoustical sensitivity of the measurement system shall be established using a sound calibrator generating a known sound pressure level at a known frequency. Sufficient sound pressure level calibrations shall be recorded during each test day to ensure that the acoustical sensitivity of the measurement system is known for the prevailing environmental

---

4. IEC 60942:2003 entitled "Electroacoustics — Sound calibrators". This IEC publication may be obtained from the Central Office of the International Electrotechnical Commission, 3 rue de Varembe, Geneva, Switzerland.

conditions corresponding with each aircraft noise measurement. Measured aircraft noise data shall not be considered valid for certification purposes unless preceded and succeeded by valid sound pressure level calibrations. The measurement system shall be considered satisfactory if the difference between the acoustical sensitivity levels recorded immediately before and immediately after each group of aircraft noise measurements on a given day is not greater than 0.5 dB. The 0.5 dB limit applies after any atmospheric pressure corrections have been applied to the calibrator output level. The arithmetic mean of the preceding and succeeding calibrations shall be used to represent the acoustical sensitivity level of the measurement system for each group of aircraft noise measurements. The calibration corrections shall be reported to the certifying authority and applied to the measured one-third octave band sound pressure levels determined from the output of the analyser.

3.9.3 For analogue (direct or FM) magnetic tape recorders each volume of recording medium, such as a reel, cartridge, or cassette, shall carry a sound pressure level calibration of at least 10 seconds duration at its beginning and end.

3.9.4 The free-field frequency response of the microphone system may be determined by using an electrostatic actuator in combination with the manufacturer's data or by testing in an anechoic free-field facility. The corrections for frequency response shall be determined within 90 days of each aircraft noise measurement and shall be reported to the certifying authority. They shall be applied to the measured one-third octave band sound pressure levels determined from the output of the analyser.

3.9.5 When the angles of incidence at the microphone of sound emitted from the aircraft are within  $\pm 30^\circ$  of grazing incidence (see Figure A2-1), a single set of free-field corrections based on grazing incidence is considered sufficient for the correction of directional response effects. Otherwise appropriate corrections for incidence effects shall be determined at the angle of incidence for each one-half second sample. Such corrections shall be reported to the certifying authority and applied to the measured one third octave band sound pressure levels determined from the output of the analyser.

3.9.6 The free-field insertion effects of the windscreen for each one-third octave nominal midband frequency from 50 Hz to 10 kHz inclusive shall be determined with sinusoidal sound signals at appropriate incidence angles on the inserted microphone. For a windscreen which is undamaged and uncontaminated, the insertion effects may be taken from the manufacturer's data. In addition, the insertion effects of the windscreen may be determined within six months of each aircraft noise measurement by a method traceable to a national standards laboratory. Tolerable changes in the insertion effects from the previous calibration at each one-third octave frequency band shall be not more than 0.4 dB. The corrections for the free-field insertion effects of the windscreen shall be reported to the certifying authority and applied to the measured one-third octave sound pressure levels determined from the output of the analyser.

3.9.7 The frequency response of the entire measurement system, exclusive of the microphone and windscreen, but otherwise configured as deployed in the field during the aircraft noise measurements, shall be established. Corrections shall be determined for each one-third octave nominal midband frequency from 50 Hz to 10 kHz inclusive. The determination shall be made at a level within 5 dB of the level corresponding to the calibration sound pressure level on the reference level range and shall utilize pink random or pseudo-random noise or alternatively discrete sine or swept sine signals. The corrections for frequency response shall be reported to the certifying authority and applied to the measured one-third octave sound pressure levels determined from the output of the analyser. If the system frequency response corrections are determined away from the field then frequency response testing shall be performed in the field to ensure the integrity of the measurement system.

3.9.8 For analogue (direct or FM) magnetic tape recorders, each volume of recording medium such as a reel, cartridge, or cassette shall carry at least 30 seconds of pink random or pseudo-random noise at its beginning and end. Aircraft noise data obtained from analogue tape-recorded signals shall be accepted as valid only if level differences in the 10 kHz one-third octave band are not more than 0.75 dB for the signals recorded at the beginning and end. For systems using analogue (direct or FM) magnetic tape recorders frequency response corrections shall be determined from pink noise recordings performed in the field during deployment for aircraft noise measurements.

3.9.9 The performance of switched attenuators in the equipment used during noise certification measurements and calibration shall be checked within six months of each aircraft noise measurement to ensure that the maximum error does not exceed 0.1 dB. The accuracy of gain-changes shall be tested or determined from manufacturers specifications to the satisfaction of the certifying authority.

### 3.10 Adjustments for background noise

3.10.1 Background noise shall be recorded (for at least 30 seconds) at the measurement points with the system gain set at the levels used for the aircraft noise measurements. The recorded background noise sample shall be representative of that which exists during the test run. The recorded aircraft noise data shall be accepted only if the background noise levels, when analysed in the same way and quoted in PNL (see 4.1.3 a)), are at least 20 dB below the maximum PNL of the aircraft.

3.10.2 Aircraft sound pressure levels within the 10 dB-down points (see 4.5.1) shall exceed mean background noise levels determined above by at least 3 dB in each one-third octave band or be adjusted using a method similar to that described in the section of the *Environmental Technical Manual* (Doc 9501), Volume I — *Procedures for the Noise Certification of Aircraft* concerning the adjustment of aircraft noise levels for the effect of background noise.

## 4. CALCULATION OF EFFECTIVE PERCEIVED NOISE LEVEL FROM MEASURED NOISE DATA

### 4.1 General

4.1.1 The metric used to quantify the certificated noise level shall be the effective perceived noise level (EPNL) expressed in units of EPNdB. EPNL is a single number evaluator taking into account the subjective effects of aircraft noise on human beings. It consists of the instantaneous perceived noise level, PNL, adjusted for spectral irregularities and for duration.

4.1.2 In order to derive the EPNL, three basic physical properties of the aircraft noise shall be measured: level, frequency distribution and variation over time. This requires the acquisition of the instantaneous sound pressure levels in spectra composed of 24 one-third octave bands, which shall be obtained for each one-half second increment of time throughout the duration over which the aircraft noise is measured.

4.1.3 The calculation procedure which utilizes physical measurements of noise to derive the EPNL evaluation measure of subjective response shall consist of the five following steps:

- a) each of the 24 one-third octave band sound pressure levels in each measured one-half second spectrum is converted to perceived noisiness by the method of Section 4.7. The noy values are combined and then converted to instantaneous perceived noise level,  $PNL(k)$  for each spectrum, measured at the  $k$ -th instant of time, by the method of Section 4.2;
- b) for each spectrum a tone correction factor,  $C(k)$ , is calculated by the method of Section 4.3 to account for the subjective response to the presence of spectral irregularities;
- c) the tone correction factor is added to the perceived noise level to obtain the tone corrected perceived noise level,  $PNLT(k)$ , for each spectrum:

$$PNLT(k) = PNL(k) + C(k);$$

- d) the history of  $PNLT(k)$  noise levels is examined to identify the maximum value,  $PNLTM$  as determined by the method of Section 4.4, and noise duration as determined by the method of Section 4.5; and
- e) effective perceived noise level, EPNL, is determined by logarithmic summation of the  $PNLT$  levels over the noise duration, and normalizing the duration to 10 seconds, by the method of Section 4.6.

## 4.2 Perceived noise level

Instantaneous perceived noise levels,  $PNL(k)$ , shall be calculated from instantaneous one-third octave band sound pressure levels,  $SPL(i,k)$ , as follows:

*Step 1.* Convert each one-third octave band,  $SPL(i,k)$ , from 50 to 10 000 Hz, to perceived noisiness,  $n(i,k)$ , by reference to the mathematical formulation of noy tables given in Section 4.7 or to the section in the *Environmental Technical Manual (Doc 9501)*, Volume I — *Procedures for the Noise Certification of Aircraft*, concerning reference tables used in the manual calculation of effective perceived noise level.

*Step 2.* Combine the perceived noisiness values,  $n(i,k)$ , found in Step 1 by the following formula:

$$\begin{aligned} N(k) &= n(k) + 0.15 \left\{ \left[ \sum_{i=1}^{24} n(i,k) \right] - n(k) \right\} \\ &= 0.85 n(k) + 0.15 \sum_{i=1}^{24} n(i,k) \end{aligned}$$

where  $n(k)$  is the largest of the 24 values of  $n(i,k)$ , and  $N(k)$  is the total perceived noisiness.

*Step 3.* Convert the total perceived noisiness,  $N(k)$ , into perceived noise level,  $PNL(k)$ , by the following formula:

$$PNL(k) = 40.0 + \frac{10}{\log 2} \log N(k)$$

*Note.*— *Perceived noise level,  $PNL(k)$ , as a function of total perceived noisiness is plotted in the section of the Environmental Technical Manual (Doc 9501), Volume I — Procedures for the Noise Certification of Aircraft, concerning reference tables used in the manual calculation of effective perceived noise level.*

## 4.3 Correction for spectral irregularities

4.3.1 Noise having pronounced spectral irregularities (for example, the maximum discrete frequency components or tones) shall be adjusted by the correction factor,  $C(k)$ , calculated as follows:

*Step 1.* Except for helicopters and tilt-rotors which start at 50 Hz (band number 1), start with the corrected sound pressure level in the 80 Hz one-third octave band (band number 3), calculate the changes in sound pressure level (or “slopes”) in the remainder of the one-third octave bands as follows:

$$\begin{aligned} s(3,k) &= \text{no value} \\ s(4,k) &= SPL(4,k) - SPL(3,k) \\ &\cdot \\ &\cdot \\ &\cdot \\ s(i,k) &= SPL(i,k) - SPL(i-1,k) \\ &\cdot \\ &\cdot \\ &\cdot \\ s(24,k) &= SPL(24,k) - SPL(23,k) \end{aligned}$$

Step 2. Encircle the value of the slope,  $s(i,k)$ , where the absolute value of the change in slope is greater than five; that is, where:

$$|\Delta s(i,k)| = |s(i,k) - s(i-1,k)| > 5$$

Step 3.

- a) If the encircled value of the slope  $s(i,k)$  is positive and algebraically greater than the slope  $s(i-1,k)$ , encircle  $SPL(i,k)$ .
- b) If the encircled value of the slope  $s(i,k)$  is zero or negative and the slope  $s(i-1,k)$  is positive, encircle  $SPL(i-1,k)$ .
- c) For all other cases, no sound pressure level value is to be encircled.

Step 4. Compute new adjusted sound pressure levels,  $SPL'(i,k)$ , as follows:

- a) For non-encircled sound pressure levels, let the new sound pressure levels equal the original sound pressure levels,  $SPL'(i,k) = SPL(i,k)$ .
- b) For encircled sound pressure levels in bands 1 to 23 inclusive, let the new sound pressure level equal the arithmetic average of the preceding and following sound pressure levels:

$$SPL'(i,k) = \frac{1}{2} [SPL(i-1,k) + SPL(i+1,k)]$$

- c) If the sound pressure level in the highest frequency band ( $i = 24$ ) is encircled, let the new sound pressure level in that band equal:

$$SPL'(24,k) = SPL(23,k) + s(23,k)$$

Step 5. Recompute new slopes  $s'(i,k)$ , including one for an imaginary 25th band, as follows:

$$s'(3,k) = s'(4,k)$$

$$s'(4,k) = SPL'(4,k) - SPL'(3,k)$$

•

•

•

$$s'(i,k) = SPL'(i,k) - SPL'(i-1,k)$$

•

•

•

$$s'(24,k) = SPL'(24,k) - SPL'(23,k)$$

$$s'(25,k) = s'(24,k)$$

Step 6. For  $i$  from 3 to 23 (or 1 to 23 for helicopters), compute the arithmetic average of the three adjacent slopes as follows:

$$\bar{s}(i,k) = \frac{1}{3} [s'(i,k) + s'(i+1,k) + s'(i+2,k)]$$

Step 7. Compute final one-third octave-band sound pressure levels,  $SPL''(i,k)$ , by beginning with band number 3 (or band number 1 for helicopters) and proceeding to band number 24 as follows:

$$\begin{aligned} SPL''(3,k) &= SPL(3,k) \\ SPL''(4,k) &= SPL''(3,k) + \bar{s}(3,k) \\ &\cdot \\ &\cdot \\ &\cdot \\ SPL''(i,k) &= SPL''(i-1,k) + \bar{s}(i-1,k) \\ &\cdot \\ &\cdot \\ &\cdot \\ SPL''(24,k) &= SPL''(23,k) + \bar{s}(23,k) \end{aligned}$$

Step 8. Calculate the differences,  $F(i,k)$ , between the original sound pressure level and the final broadband sound pressure level as follows:

$$F(i,k) = SPL(i,k) - SPL''(i,k)$$

and note only values equal to or greater than one and a half.

Step 9. For each of the relevant one-third octave bands (3 to 24), determine tone correction factors from the sound pressure level differences,  $F(i,k)$ , and Table A2-2.

Step 10. Designate the largest of the tone correction factors, determined in Step 9, as  $C(k)$ . An example of the tone correction procedure is given in the section of the *Environmental Technical Manual* (Doc 9501), Volume I — *Procedures for the Noise Certification of Aircraft*, concerning reference tables used in the manual calculation of effective perceived noise level.

Tone corrected perceived noise levels  $PNLT(k)$  shall be determined by adding the  $C(k)$  values to corresponding  $PNL(k)$  values, that is:

$$PNLT(k) = PNL(k) + C(k)$$

For any  $i$ -th one-third octave band, at any  $k$ -th increment of time, for which the tone correction factor is suspected to result from something other than (or in addition to) an actual tone (or any spectral irregularity other than aircraft noise), an additional analysis may be made using a filter with a bandwidth narrower than one-third of an octave. If the narrow band analysis corroborates these suspicions, then a revised value for the broadband sound pressure level,  $SPL'(i,k)$ , shall be determined from the narrow band analysis and used to compute a revised tone correction factor for that particular one-third octave band.

*Note.*— Other methods of rejecting spurious tone corrections such as those described in Chapter 4 of the *Environmental Technical Manual* (Doc 9501), Volume I — *Procedures for the Noise Certification of Aircraft* may be used.



**Table A2-2. Tone correction factors**

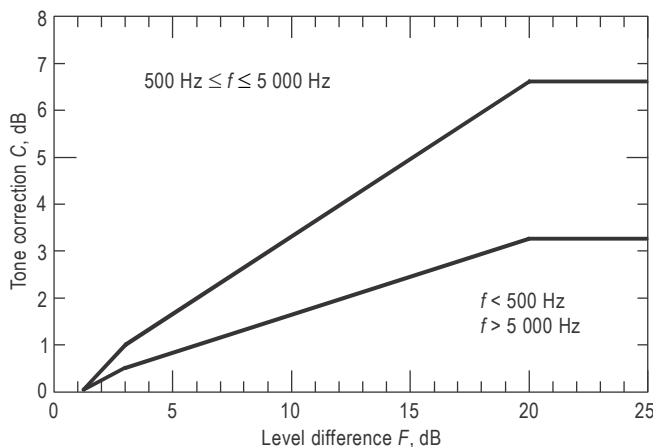

Frequency <i>f</i> , Hz	Level difference <i>F</i> , dB	Tone correction <i>C</i> , dB
$50 \leq f < 500$	$1\frac{1}{2}^* \leq F < 3$	$F/3 - \frac{1}{2}$
	$3 \leq F < 20$	$F/6$
	$20 \leq F$	$3\frac{1}{3}$
$500 \leq f \leq 5\,000$	$1\frac{1}{2}^* \leq F < 3$	$2 F/3 - 1$
	$3 \leq F < 20$	$F/3$
	$20 \leq F$	$6\frac{2}{3}$
$5\,000 < f \leq 10\,000$	$1\frac{1}{2}^* \leq F < 3$	$F/3 - \frac{1}{2}$
	$3 \leq F < 20$	$F/6$
	$20 \leq F$	$3\frac{1}{3}$

\* See Step 8 of 4.3.1.

4.3.2 This procedure will underestimate EPNL if an important tone is of a frequency such that it is recorded in two adjacent one-third octave bands. It shall be demonstrated to the satisfaction of the certificating authority:

*either* that this has not occurred,

*or* that if it has occurred that the tone correction has been adjusted to the value it would have had if the tone had been recorded fully in a single one-third octave band.

#### 4.4 Maximum tone corrected perceived noise level

4.4.1 The tone corrected perceived noise levels,  $PNLT(k)$ , are calculated from measured one-half second values of SPL in accordance with the procedure of Section 4.3. The maximum tone corrected perceived noise level, PNLTM, shall be the maximum value of  $PNLT(k)$ , adjusted if necessary for the presence of bandsharing by the method of Section 4.4.2. The increment associated with PNLTM is designated as  $k_M$ .

*Note.*— Figure A2-2 is an example of a flyover noise time history where the maximum value is clearly indicated.

4.4.2 The tone at PNLTM may be suppressed due to one-third octave bandsharing of that tone. To identify whether this is the case, the average of the tone correction factors of the PNLTM spectrum and the two preceding and two succeeding spectra is calculated. If the value of the tone correction factor  $C(k_M)$  for the spectrum associated with PNLTM is less than the average value of  $C(k)$  for the five consecutive spectra ( $k_{M-2}$ ) through ( $k_{M+2}$ ), then the average value  $C_{avg}$  shall be used to compute a bandsharing adjustment,  $\Delta_B$ , and a value of PNLTM adjusted for bandsharing.

$$C_{avg} = [C(k_{M-2}) + C(k_{M-1}) + C(k_M) + C(k_{M+1}) + C(k_{M+2})] / 5$$

If  $C_{avg} > C(k_M)$ , then  $\Delta_B = C_{avg} C(k_M)$  and

$$PNLTM = PNLT(k_M) + \Delta_B$$

4.4.3 The value of PNLTM adjusted for bandsharing shall be used for the calculation of EPNL.

#### 4.5 Noise duration

4.5.1 The limits of the noise duration are bounded by the first and last 10 dB-down points. These are determined by examination of the  $PNLT(k)$  time history with respect to PNLTM:

- a) the earliest value of  $PNLT(k)$  which is greater than  $PNLTM - 10$  dB is identified. This value and the value of PNLT for the preceding point are compared. Whichever of these two points is associated with the value closest to  $PNLTM - 10$  dB is identified as the first 10 dB-down point. The associated increment is designated as  $k_F$ ; and
- b) the last value of  $PNLT(k)$  which is greater than  $PNLTM - 10$  dB is identified. This value and the value of PNLT for the following point are compared. Whichever of these two points is associated with the value closest to  $PNLTM - 10$  dB is identified as the last 10 dB-down point. The associated increment is designated as  $k_L$ .

*Note.*— Figure A2-2 illustrates the selection of the first and last 10 dB-down points,  $k_F$  and  $k_L$ .

4.5.2 The noise duration in seconds shall be equal to the number of  $PNLT(k)$  values from  $k_F$  to  $k_L$  inclusive, times 0.5.

4.5.3 The value of PNLTM used for determination of the 10 dB-down points shall include the adjustment for the presence of bandsharing,  $\Delta_B$ , by the method of Section 4.4.2.

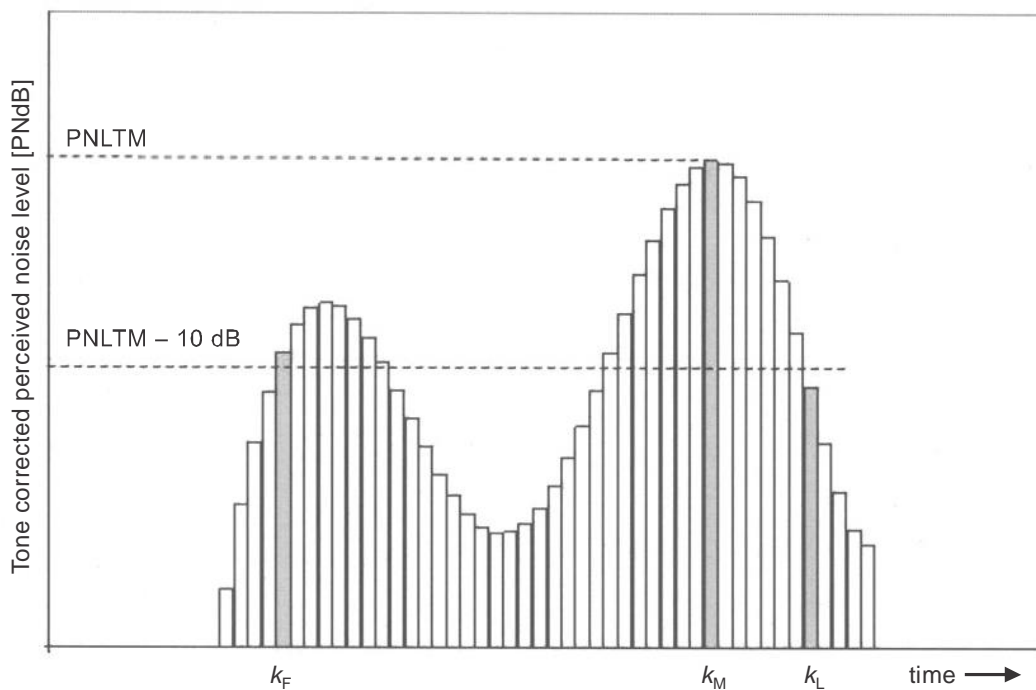

Figure A2-2. Example of a flyover noise time history

#### 4.6 Effective perceived noise level

4.6.1 If the instantaneous tone corrected perceived noise level is expressed in terms of a continuous function with time,  $PNLT(t)$ , then the effective perceived noise level, EPNL, would be defined as the level, in EPNdB, of the time integral of  $PNLT(t)$  over the noise event duration, normalized to a reference duration,  $t_0$ , of 10 seconds. The noise event duration is bounded by  $t_1$ , the time when  $PNLT(t)$  is first equal to  $PNLTM - 10$ , and  $t_2$ , the time when  $PNLT(t)$  is last equal to  $PNLTM - 10$ .

$$EPNL = 10 \log \frac{1}{t_0} \int_{t_1}^{t_2} 10^{0.1 PNLT(t)} dt$$

4.6.2 In practice  $PNLT$  is not expressed as a continuous function with time since it is computed from discrete values of  $PNLT(k)$  every half second. In this case the basic working definition for EPNL is obtained by replacing the integral in Section 4.6.1 with the following summation expression:

$$EPNL = 10 \log \frac{1}{t_0} \sum_{k_F}^{k_L} 10^{0.1 PNLT(k)} \Delta t$$

For  $t_0 = 10$  and  $\Delta t = 0.5$ , this expression can be simplified as follows:

$$EPNL = 10 \log \sum_{k_F}^{k_L} 10^{0.1 PNLT(k)} - 13$$

Note.— 13 dB is a constant relating the one-half second values of  $PNLT(k)$  to the 10-second reference duration  $t_0$ :  $10 \log (0.5/10) = -13$ .

4.6.3 The value of PNLTM used for determination of EPNL shall include the adjustment for the presence of bandsharing,  $\Delta_B$ , by the method of Section 4.4.2.

#### 4.7 Mathematical formulation of noy tables

4.7.1 The relationship between sound pressure level (SPL) and the logarithm of perceived noisiness is illustrated in Table A2-3 and Figure A2-3.

4.7.2 The important aspects of the mathematical formulation are:

- a) the slopes ( $M(b)$ ,  $M(c)$ ,  $M(d)$  and  $M(e)$ ) of the straight lines;
- b) the intercepts ( $SPL(b)$  and  $SPL(c)$ ) of the lines on the SPL axis; and
- c) the coordinates of the discontinuities,  $SPL(a)$  and  $\log n(a)$ ;  $SPL(d)$  and  $\log n = -1.0$ ; and  $SPL(e)$  and  $\log n = \log(0.3)$ .

4.7.3 The equations are as follows:

- a)  $SPL \geq SPL(a)$   
 $n = \text{antilog} \{M(c) [SPL - SPL(c)]\}$
- b)  $SPL(b) \leq SPL < SPL(a)$   
 $n = \text{antilog} \{M(b) [SPL - SPL(b)]\}$
- c)  $SPL(e) \leq SPL < SPL(b)$   
 $n = 0.3 \text{ antilog} \{M(e) [SPL - SPL(e)]\}$
- d)  $SPL(d) \leq SPL < SPL(e)$   
 $n = 0.1 \text{ antilog} \{M(d) [SPL - SPL(d)]\}$

4.7.4 Table A2-3 lists the values of the constants necessary to calculate perceived noisiness as a function of sound pressure level.

## 5. REPORTING OF DATA TO THE CERTIFICATING AUTHORITY

### 5.1 General

5.1.1 Data representing physical measurements or corrections to measured data shall be recorded in permanent form and appended to the record.

5.1.2 All corrections shall be approved by the certificating authority. In particular the corrections to measurements for equipment response deviations shall be reported.

5.1.3 Estimates of the individual errors inherent in each of the operations employed in obtaining the final data shall be reported, if required.

Table A2-3. Constants for mathematically formulated noy values

BAND (i)	ISO BAND	<i>f</i> Hz	SPL(a)	SPL(b)	SPL(c)	SPL(d)	SPL(e)	<i>M</i> (b)	<i>M</i> (c)	<i>M</i> (d)	<i>M</i> (e)
1	17	50	91.0	64	52	49	55	0.043478	0.030103	0.079520	0.058098
2	18	63	85.9	60	51	44	51	0.040570	0.030103	0.068160	0.058098
3	19	80	87.3	56	49	39	46	0.036831	0.030103	0.068160	0.052288
4	20	100	79.9	53	47	34	42	0.036831	0.030103	0.059640	0.047534
5	21	125	79.8	51	46	30	39	0.035336	0.030103	0.053013	0.043573
6	22	160	76.0	48	45	27	36	0.033333	0.030103	0.053013	0.043573
7	23	200	74.0	46	43	24	33	0.033333	0.030103	0.053013	0.040221
8	24	250	74.9	44	42	21	30	0.032051	0.030103	0.053013	0.037349
9	25	315	94.6	42	41	18	27	0.030675	0.030103	0.053013	0.034859
10	26	400	∞	40	40	16	25	0.030103	↑	0.053013	0.034859
11	27	500	∞	40	40	16	25	0.030103		0.053013	0.034859
12	28	630	∞	40	40	16	25	0.030103		0.053013	0.034859
13	29	800	∞	40	40	16	25	0.030103		0.053013	0.034859
14	30	1 000	∞	40	40	16	25	0.030103		0.053013	0.034859
15	31	1 250	∞	38	38	15	23	0.030103		0.059640	0.034859
16	32	1 600	∞	34	34	12	21	0.029960		0.053013	0.040221
17	33	2 000	∞	32	32	9	18	0.029960		0.053013	0.037349
18	34	2 500	∞	30	30	5	15	0.029960		0.047712	0.034859
19	35	3 150	∞	29	29	4	14	0.029960		0.047712	0.034859
20	36	4 000	∞	29	29	5	14	0.029960		0.053013	0.034859
21	37	5 000	∞	30	30	6	15	0.029960	↓	0.053013	0.034859
22	38	6 300	∞	31	31	10	17	0.029960	0.029960	0.068160	0.037349
23	39	8 000	44.3	37	34	17	23	0.042285	0.029960	0.079520	0.037349
24	40	10 000	50.7	41	37	21	29	0.042285	0.029960	0.059640	0.043573

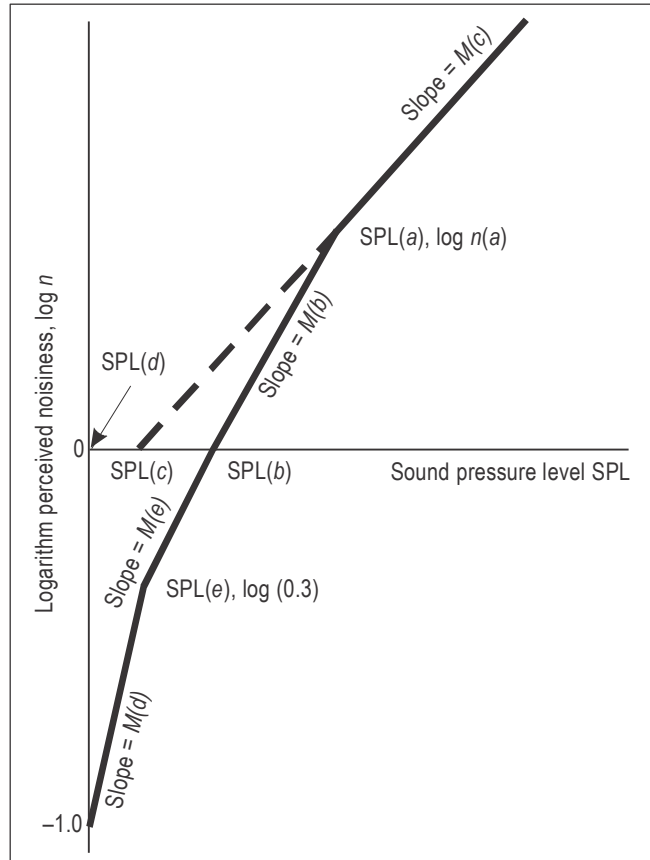

Figure A2-3. Perceived noisiness as a function of sound pressure level

## 5.2 Data reporting

5.2.1 Measured and corrected sound pressure levels shall be presented in one-third octave band levels obtained with equipment conforming to the Standards described in Section 3 of this appendix.

5.2.2 The type of equipment used for measurement and analysis of all acoustic performance and meteorological data shall be reported.

5.2.3 The following atmospheric environmental data, measured immediately before, after, or during each test at the observation points prescribed in Section 2 of this appendix shall be reported:

- a) air temperature and relative humidity;
- b) wind speeds and wind directions; and
- c) atmospheric pressure.

5.2.4 Comments on local topography, ground cover, and events that might interfere with sound recordings shall be reported.

5.2.5 The following information shall be reported:

- a) type, model and serial numbers (if any) of aircraft, engines, propellers or rotors (as applicable);
- b) gross dimensions of aircraft and location of engines and rotors (if applicable);
- c) aircraft gross mass for each test run and centre of gravity range for each series of test runs;
- d) aircraft configuration such as flap, air brakes and landing gear positions and propeller pitch angles (if applicable);
- e) whether auxiliary power units (APU), when fitted, are operating;
- f) conditions of pneumatic engine bleeds and engine power take-offs;
- g) indicated airspeed in kilometres per hour (knots);
- h)
  - 1) *for jet aeroplanes*: engine performance in terms of net thrust, engine pressure ratios, jet exhaust temperatures and fan or compressor shaft rotational speeds as determined from aeroplane instruments and manufacturer's data;
  - 2) *for propeller-driven aeroplanes*: engine performance in terms of brake horsepower and residual thrust or equivalent shaft horsepower or engine torque and propeller rotational speed as determined from aeroplane instruments and manufacturer's data;
  - 3) *for helicopters*: engine performance and rotor speed in rpm during each demonstration;
- i) aircraft flight path and ground speed during each demonstration; and
- j) any aircraft modifications or non-standard equipment likely to affect the noise characteristics of the aircraft and approved by the certifying authority.

### 5.3 Reporting of noise certification reference conditions

Aircraft position and performance data and the noise measurements shall be corrected to the noise certification reference conditions as specified in the relevant chapter of Part II, and these conditions, including reference parameters, procedures and configurations shall be reported.

### 5.4 Validity of results

5.4.1 Three average reference EPNL values and their 90 per cent confidence limits shall be produced from the test results and reported, each such value being the arithmetical average of the adjusted acoustical measurements for all valid test runs at the appropriate measurement point (take-off, approach, or lateral or overflight, in the case of helicopters). If more than one acoustic measurement system is used at any single measurement location, the resulting data for each test run shall be averaged as a single measurement. For helicopters, the three microphone test results for each flight should be averaged as a single measurement. The calculation shall be performed by:

- a) computing the arithmetic average for each flight phase using the values from each reference microphone point;
- b) computing the overall arithmetic average for each appropriate reference condition (take-off, overflight or approach) using the values in a) and the related 90 per cent confidence limits.

*Note.— For helicopters a flight shall only be considered valid if simultaneous measurements are made at all three noise measurement locations.*

5.4.2 The minimum sample size acceptable for each of the three certification measuring points for aeroplanes and for each set of three microphones for helicopters is six. The samples shall be large enough to establish statistically for each of the three average noise certification levels a 90 per cent confidence limit not exceeding  $\pm 1.5$  EPNdB. No test result shall be omitted from the averaging process unless otherwise specified by the certifying authority.

*Note.— Methods for calculating the 90 per cent confidence interval are given in the section of the Environmental Technical Manual (Doc 9501), Volume I — Procedures for the Noise Certification of Aircraft, concerning the calculation of confidence intervals.*

5.4.3 The average EPNL figures obtained by the foregoing process shall be those by which the noise performance of the aircraft is assessed against the noise certification criteria.

## 6. RESERVED

## 7. SOUND ATTENUATION IN AIR

7.1 The atmospheric attenuation of sound shall be determined in accordance with the procedure presented below.

7.2 The relationship between sound attenuation, frequency, temperature and humidity is expressed by the following equations:

$$\alpha(i) = 10^{[2.05 \log(f_o/1\ 000) + 1.1394 \times 10^{-3}\theta - 1.916984]} + \eta(\delta) \times 10^{[\log(f_o) + 8.42994 \times 10^{-3}\theta - 2.755624]}$$

$$\delta = \sqrt{\frac{1010}{f_o}} 10^{(\log RH - 1.328924 + 3.179768 \times 10^{-2} \times T)} \times 10^{(-2.173716 \times 10^{-4} \times T^2 + 1.7496 \times 10^{-6} \times T^3)}$$

where:

$\eta(\delta)$  is given by Table A2-4 and  $f_o$  by Table A2-5;

$\alpha(i)$  being the attenuation coefficient in dB/100 m;

T being the temperature in °C; and

RH being the relative humidity expressed as a percentage.

7.3 The equations given in 7.2 are convenient for calculation by means of a computer.



Table A2-4. Values of  $\eta(\delta)$ 

$\delta$	$\eta(\delta)$	$\delta$	$\eta(\delta)$
0.00	0.000	2.50	0.450
0.25	0.315	2.80	0.400
0.50	0.700	3.00	0.370
0.60	0.840	3.30	0.330
0.70	0.930	3.60	0.300
0.80	0.975	4.15	0.260
0.90	0.996	4.45	0.245
1.00	1.000	4.80	0.230
1.10	0.970	5.25	0.220
1.20	0.900	5.70	0.210
1.30	0.840	6.05	0.205
1.50	0.750	6.50	0.200
1.70	0.670	7.00	0.200
2.00	0.570	10.00	0.200
2.30	0.495		

A term of quadratic interpolation shall be used where necessary.

Table A2-5. Value of  $f_o$ 

Centre frequency of the 1/3 octave band (Hz)	$f_o$ (Hz)	Centre frequency of the 1/3 octave band (Hz)	$f_o$ (Hz)
50	50	800	800
63	63	1 000	1 000
80	80	1 250	1 250
100	100	1 600	1 600
125	125	2 000	2 000
160	160	2 500	2 500
200	200	3 150	3 150
250	250	4 000	4 000
315	315	5 000	4 500
400	400	6 300	5 600
500	500	8 000	7 100
630	630	10 000	9 000

## 8. ADJUSTMENT OF AIRCRAFT FLIGHT TEST RESULTS

### 8.1 Flight profiles and noise geometry

Flight profiles for both test and reference conditions are described by their geometry relative to the ground, the associated aircraft ground speed, and, in the case of aeroplanes, the associated engine noise performance parameter(s) used for determining the acoustic emission of the aeroplane. Idealized aircraft flight profiles are described in 8.1.1 for aeroplanes and 8.1.2 for helicopters.

*Note.*— The “noise flight path” referred to in 8.1.1 and 8.1.2 is defined in accordance with the requirements of 2.3.2.

#### 8.1.1 Aeroplane flight profiles

##### 8.1.1.1 Reference lateral full-power profile characteristics

Figure A2-4 illustrates the profile characteristics for the aeroplane take-off procedure for noise measurements made at the lateral full-power noise measurement points:

- a) the aeroplane begins the take-off roll at point A and lifts off at point B at full take-off power. The climb angle increases between points B and C. From point C the climb angle is constant up to point F, the end of the noise flight path; and
- b) positions  $K_{2L}$  and  $K_{2R}$  are the left and right lateral noise measurement points for jet aeroplanes, located on a line parallel to and at the specified distance from the runway centre line, where the noise level during take-off is greatest. Position  $K_4$  is the “lateral” full-power noise measurement point for propeller-driven aeroplanes located on the extended centre line of the runway vertically below the point on the climb-out flight path where the aeroplane is at the specified height.

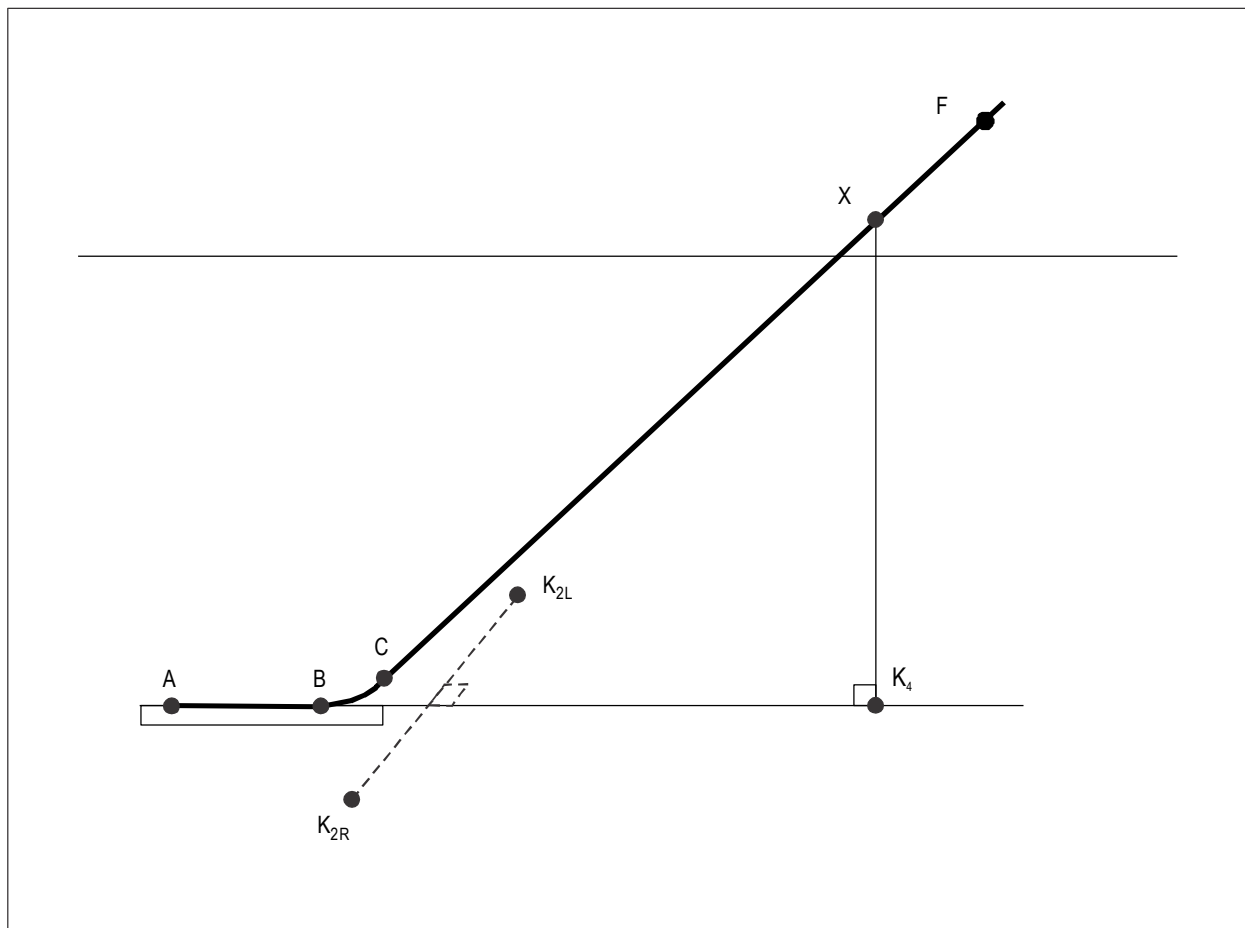

Figure A2-4. Reference aeroplane lateral full-power profile characteristics

## 8.1.1.2 Reference flyover profile characteristics

Figure A2-5 illustrates the profile characteristics for the aeroplane take-off procedure for noise measurements made at the flyover noise measurement point:

- a) the aeroplane begins the take-off roll at point A and lifts off at point B at full take-off power. The climb angle increases between points B and C. From point C the climb angle is constant up to point D where thrust (or power) reduction is initiated. At point E the thrust (or power) and climb angle are once more stabilized and the aeroplane continues to climb at a constant angle up to point F, the end of the noise flight path; and

*Note.*— The flyover profile may be flown without thrust (power) reduction in which case point C will extend through point D at a constant climb angle.

- b) position  $K_1$  is the flyover noise measurement point and  $AK_1$  is the specified distance from start of roll to the flyover noise measuring point.

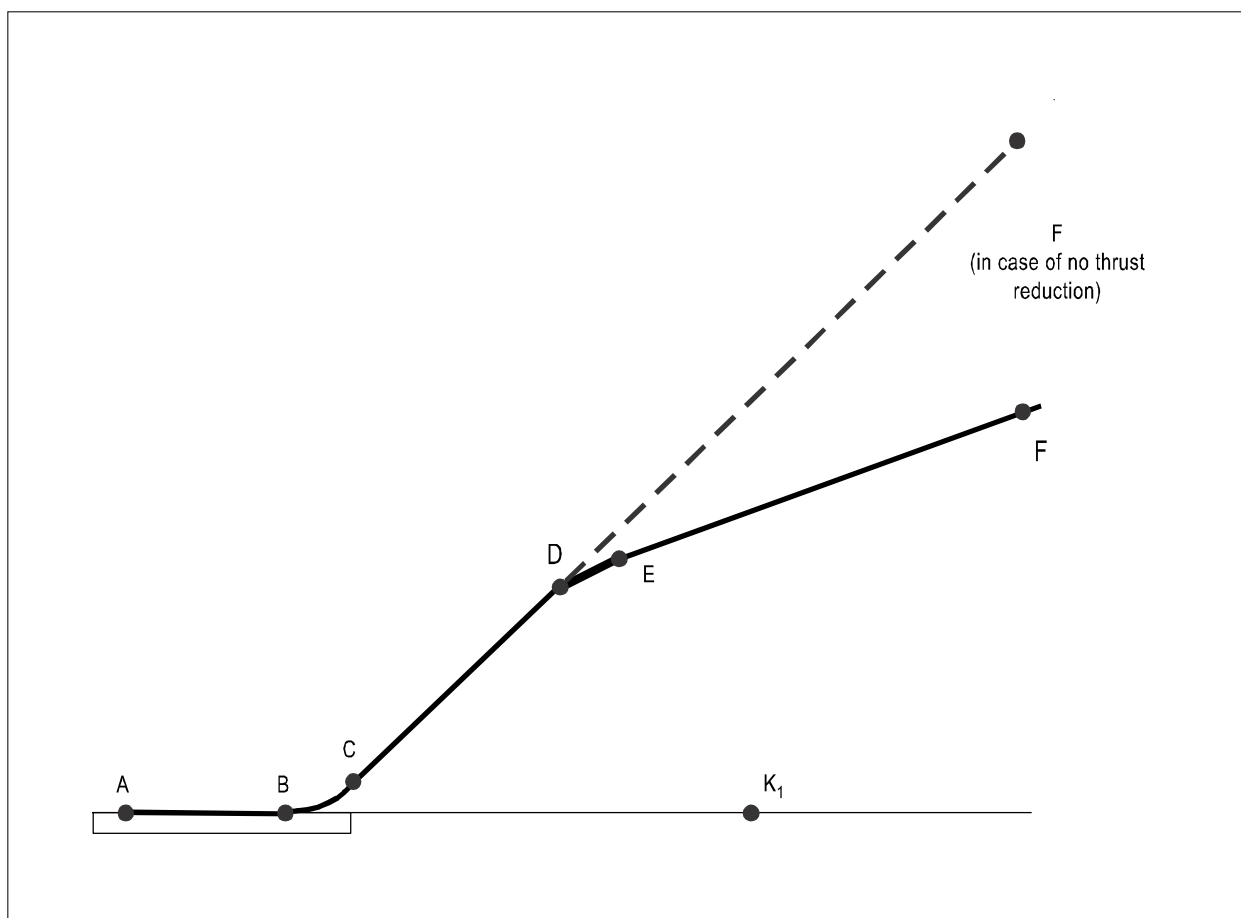

Figure A2-5. Reference aeroplane flyover profile characteristics

### 8.1.1.3 Reference approach profile characteristics

Figure A2-6 illustrates the profile characteristics for the aeroplane approach procedure for noise measurements made at the approach noise measurement point:

- a) the aeroplane is initially stabilized on the specified glideslope at point G and continues through point H and point I, touching down on the runway at point J; and
- b) position  $K_3$  is the approach noise measurement point and  $K_3O$  is the specified distance from the approach noise measurement point to the runway threshold.

*Note.*— The aeroplane reference point during approach measurements shall be the ILS antenna.

## 8.1.2 Helicopter flight profiles

### 8.1.2.1 Reference take-off profile characteristics

Figure A2-7 illustrates the profile characteristics for the helicopter take-off procedure for noise measurements made at the take-off noise measurement point:

- a) the helicopter is initially stabilized in level flight at point A at the best rate of climb speed  $V_Y$ . The helicopter continues to point B where take-off power is applied, and a steady climb is initiated. A steady climb is maintained through point X and beyond to point F, the end of the noise flight path; and
- b) position  $K_1$  is the take-off noise measurement point, and  $NK_1$  is the specified distance from the initiation of the steady climb to the take-off reference noise measurement point. Positions  $K_1'$  and  $K_1''$  are associated noise measurement points located on a line  $K_1'K_1''$  through  $K_1$  at right angles to the take-off flight track TM and at the specified distance either side of  $K_1$ .

*Note.*— In practice the point at which take-off power is applied will be some distance before point B.

### 8.1.2.2 Reference overflight profile characteristics

Figure A2-8 illustrates the profile characteristics for the helicopter overflight procedure for noise measurements made at the overflight noise measurement points:

- a) the helicopter is stabilized in level flight at point D and flies through point W, overhead the overflight noise measurement point  $K_2$ , to point E, the end of the noise flight path; and
- b) position  $K_2$  is the overflight noise measurement point, and  $K_2W$  is the specified height of the helicopter overhead the overflight noise measurement point. Positions  $K_2'$  and  $K_2''$  are associated noise measurement points located on a line  $K_2'K_2''$  through  $K_2$  at right angles to the overflight flight track RS and at the specified distance either side of  $K_2$ .

### 8.1.2.3 Reference approach profile characteristics

Figure A2-9 illustrates the profile characteristics for the helicopter approach procedure for noise measurements made at the approach noise measurement points:

- a) the helicopter is initially stabilized on the specified glideslope at point G and continues through point H and point I, touching down at point J; and

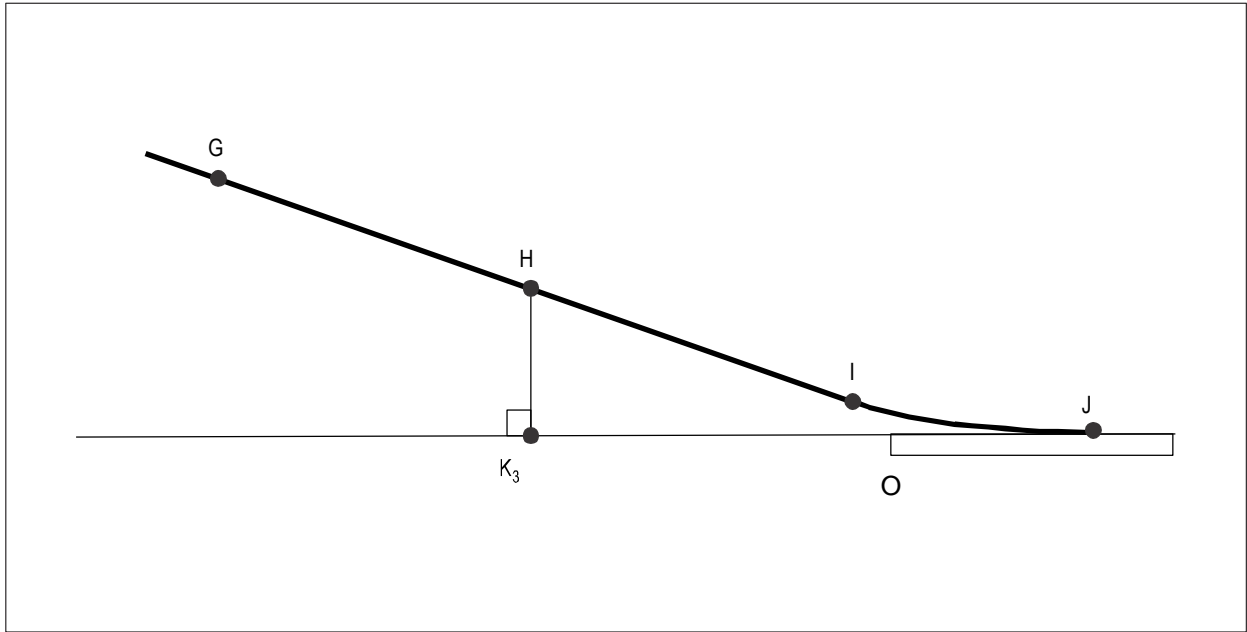

Figure A2-6. Reference aeroplane approach profile characteristics

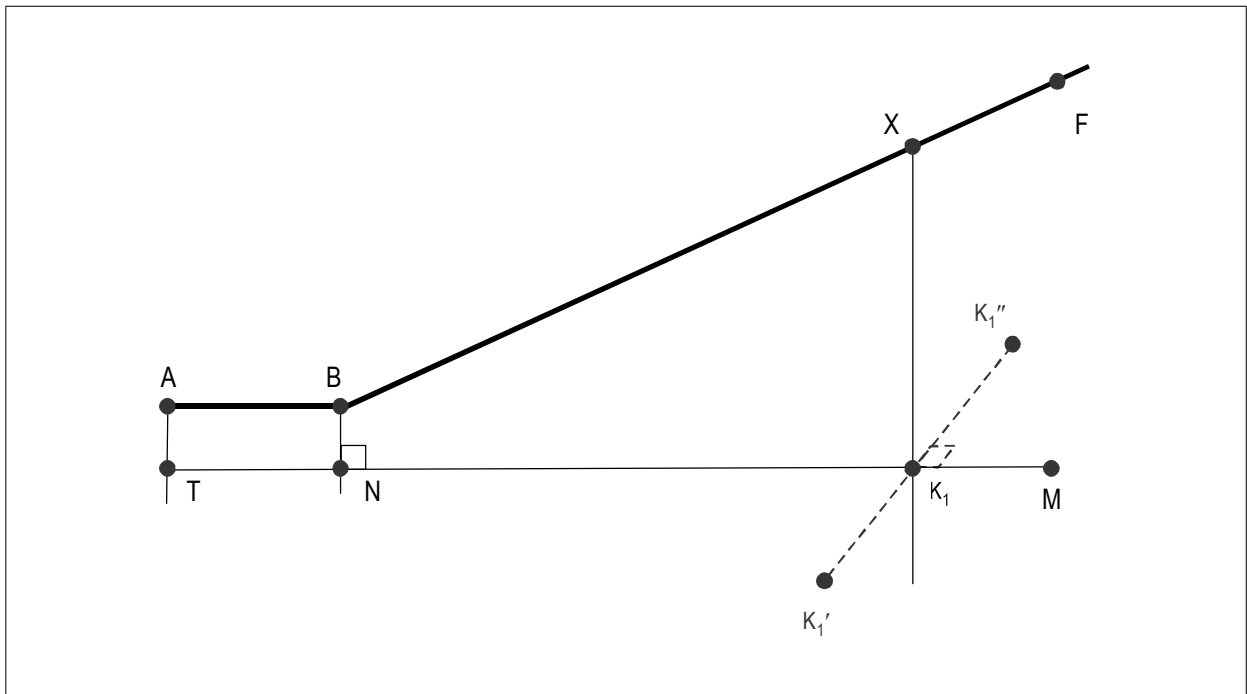

Figure A2-7. Reference helicopter take-off profile characteristics

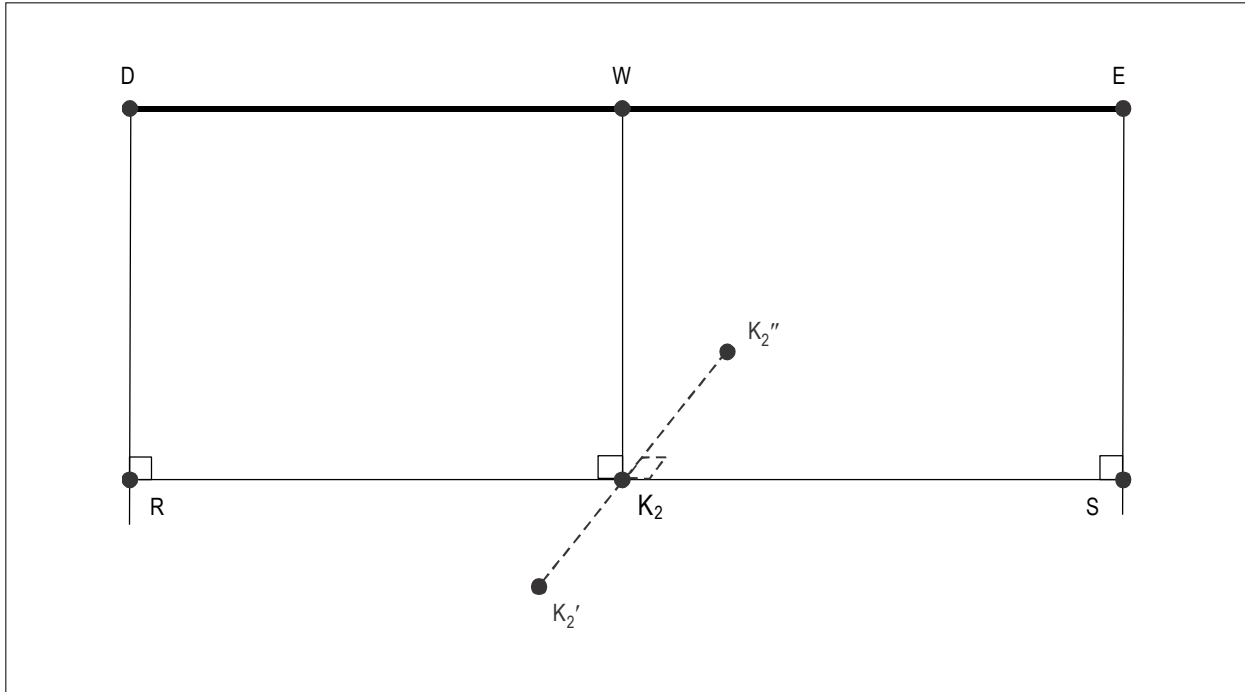

Figure A2-8. Reference helicopter overflight profile characteristics

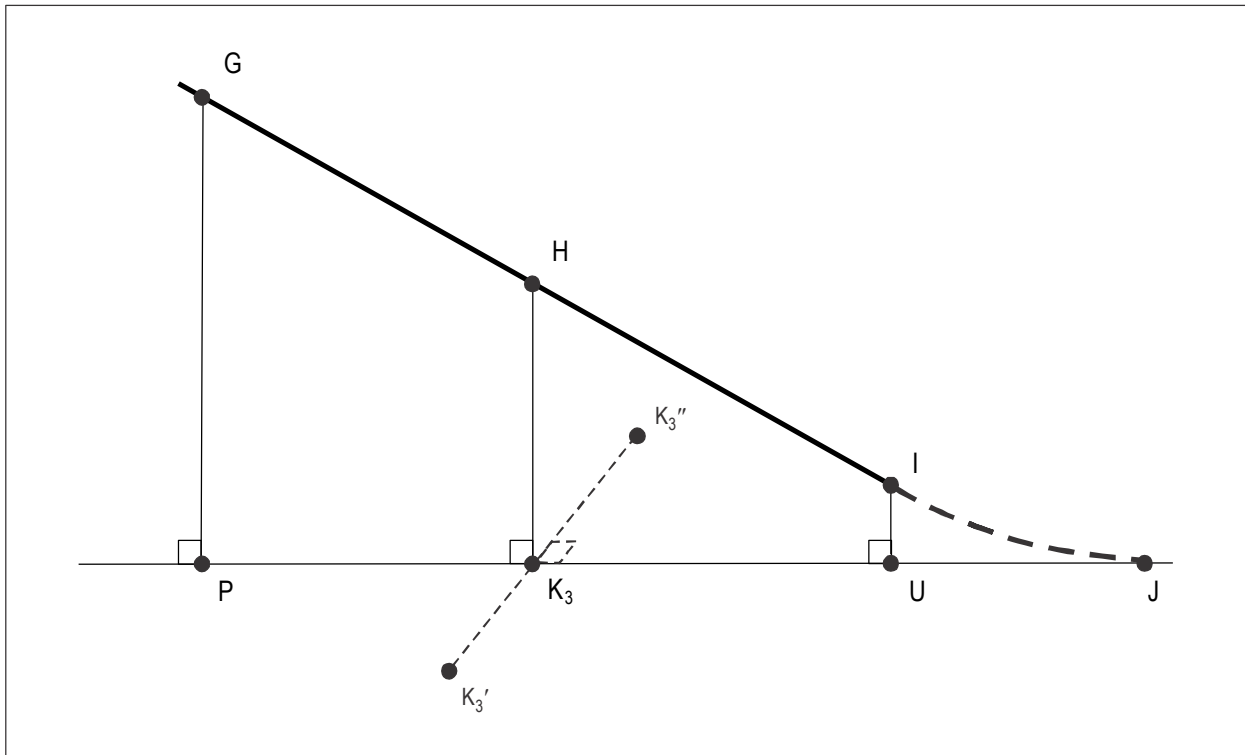

Figure A2-9. Reference helicopter approach profile characteristics

- b) position  $K_3$  is the approach noise measurement point, and  $K_3H$  is the specified height of the helicopter overhead the approach noise measurement point. Positions  $K_3'$  and  $K_3''$  are associated noise measurement points located on a line  $K_3'K_3''$  at right angles to the approach flight track PU and at the specified distance either side of  $K_3$ .

### 8.1.3 Adjustment of measured noise levels from measured to reference profile in the calculation of EPNL

*Note.— The “useful portion of the measured flight path” referred to in this section is defined in accordance with the requirements of 2.3.2.*

8.1.3.1 For the case of a microphone located beneath the flight path, the portions of the test flight path and the reference flight path which are significant for the adjustment of the measured noise levels from the measured profile to the reference profile in the EPNL calculation are illustrated in Figure A2-10, where:

- a) XY represents the useful portion of the measured flight path (Figure A2-10 a)), and  $X_rY_r$  that of the corresponding reference flight path (Figure A2-10 b)); and
- b) K is the actual noise measurement point and  $K_r$  the reference noise measurement point. Q represents the aircraft position on the measured flight path at which the noise was emitted and observed as PNLTM at point K. The angle between QK and the direction of flight along the measured flight path is  $\theta$ , the sound emission angle.  $Q_r$  is the corresponding position on the reference flight path where the angle between  $Q_rK_r$  is also  $\theta$ . QK and  $Q_rK_r$  are, respectively, the measured and reference sound propagation paths.

*Note.— This situation will apply in the case of aeroplanes for the flyover, approach, and for propeller-driven aeroplanes only, the lateral full-power noise measurements, and in the case of helicopters for the take-off, overflight, and approach noise measurements for the centre microphone only.*

8.1.3.2 For the case of a microphone laterally displaced to the side of the flight path, the portions of the test flight path and the reference flight path which are significant for the adjustment of the measured noise levels from the measured profile to the reference profile in the EPNL calculation are illustrated in Figure A2-11, where:

- a) XY represents the useful portion of the measured flight path (Figure A2-11 a)), and  $X_rY_r$  that of the corresponding reference flight path (Figure A2-11 b)); and
- b) K is the actual noise measurement point and  $K_r$  the reference noise measurement point. Q represents the aircraft position on the measured flight path at which the noise was emitted and observed as PNLTM at point K. The angle between QK and the direction of flight along the measured flight path is  $\theta$ , the sound emission angle. The angle between QK and the ground is  $\psi$ , the elevation angle.  $Q_r$  is the corresponding position on the reference flight path where the angle between  $Q_rK_r$  and the direction of flight along the reference flight path is also  $\theta$ , and the angle between  $Q_rK_r$  and the ground is  $\psi_R$ , where in the case of aeroplanes, the difference between  $\psi$  and  $\psi_R$  is minimized.

*Note.— This situation will apply in the case of jet aeroplanes for the lateral full-power noise measurements, and in the case of helicopters for the take-off, overflight and approach noise measurements for the two laterally displaced microphones only.*

8.1.3.3 In both situations the sound emission angle  $\theta$  shall be established using three-dimensional geometry.

8.1.3.4 In the case of lateral full-power noise measurements of jet aeroplanes the extent to which differences between  $\psi$  and  $\psi_R$  can be minimized is dependent on the geometrical restrictions imposed by the need to maintain the reference microphone on a line parallel to the extended runway centre line.

*Note.— In the case of helicopter measurements, there is no requirement to minimize the difference between  $\psi$  and  $\psi_R$ .*

8.1.3.5 The reference ground track is defined as the vertical projection of the reference flight path onto the ground.

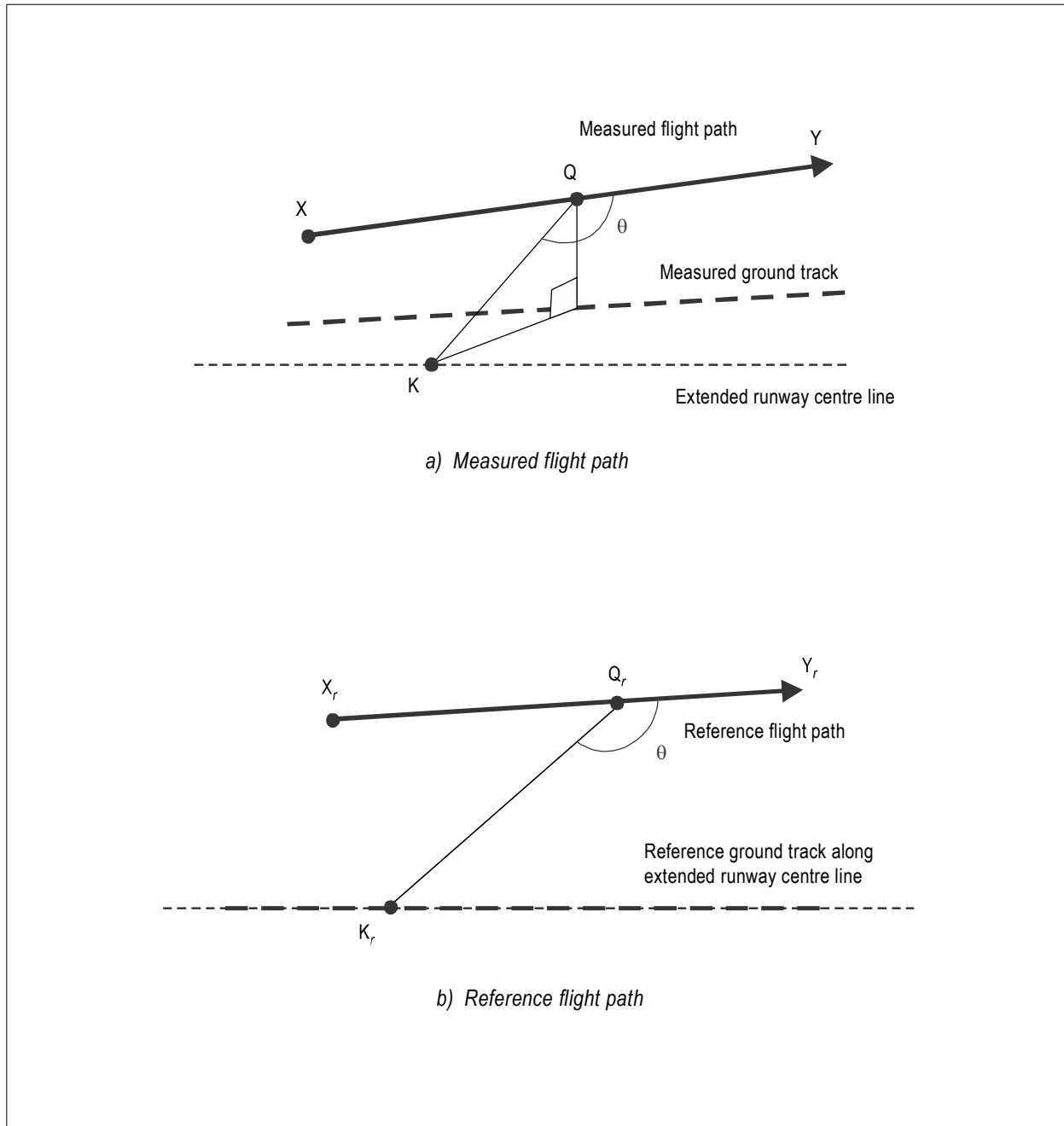

**Figure A2-10. Profile characteristics influencing noise level for microphone located beneath the flight path**



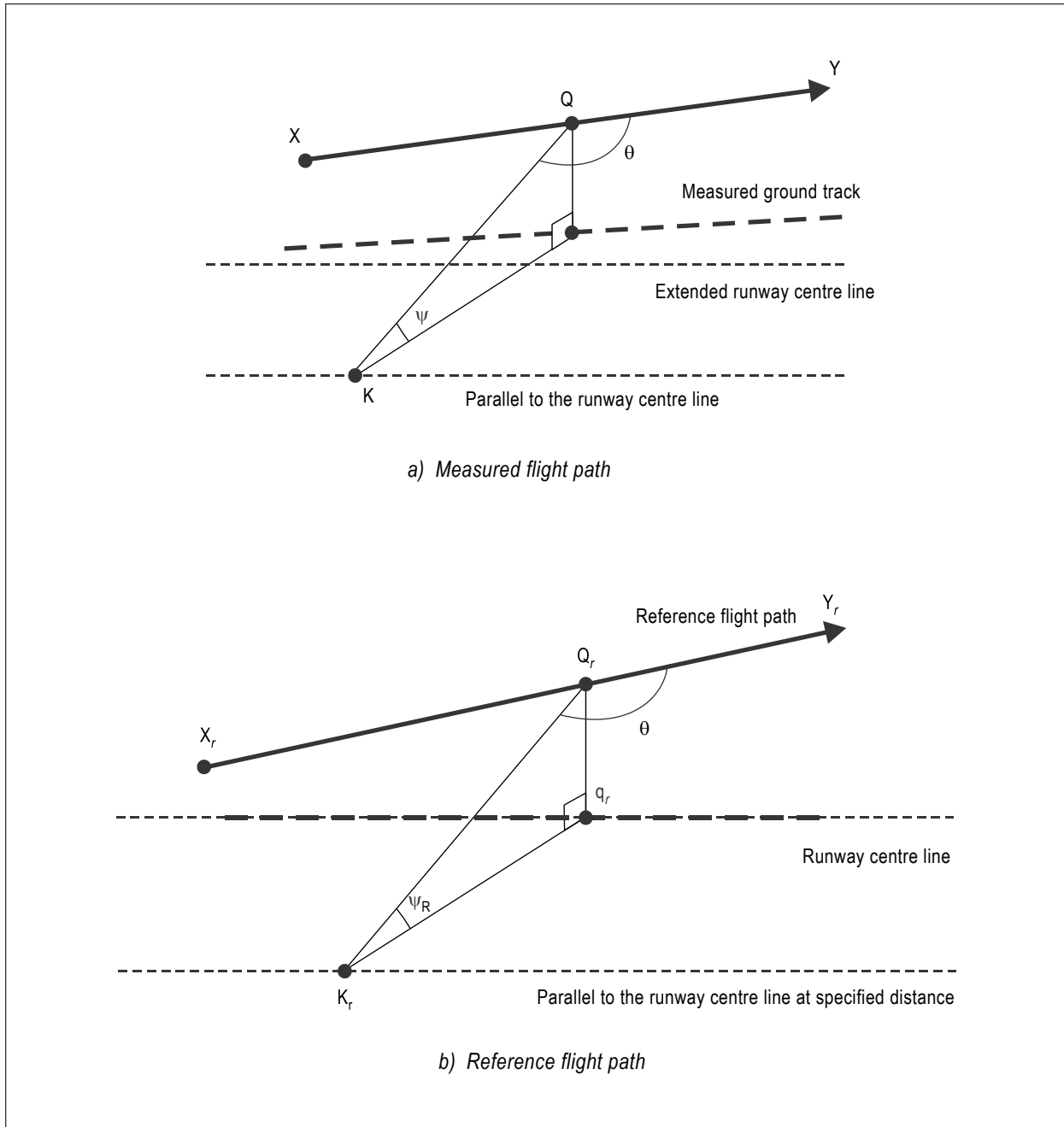

**Figure A2-11. Profile characteristics influencing noise level for laterally displaced microphone**

## 8.2 Selection of adjustment method

8.2.1 Adjustments to the measured noise values shall be made for the following:

- a) aircraft flight path and velocity relative to the microphone;
- b) sound attenuation in air; and
- c) source noise.

8.2.2 For helicopters, the simplified method described in 8.3 shall be used.

*Note.— The integrated method may be approved by the certificating authority as being equivalent to the simplified method.*

8.2.3 For aeroplanes, either the simplified method, described in 8.3, or the integrated method, described in 8.4, shall be used for the lateral, flyover or approach conditions. The integrated method shall be used when:

- a) for flyover, the absolute value of the difference between the value of  $EPNL_R$ , when calculated according to the simplified method described in 8.3, and the measured value of EPNL calculated according to the procedure described in 4.1.3 is greater than 8 EPNdB;
- b) for approach, the absolute value of the difference between the value of  $EPNL_R$ , when calculated according to the simplified method described in 8.3, and the measured value of EPNL calculated according to the procedure described in 4.1.3 is greater than 4 EPNdB; or
- c) for flyover or approach, the value of  $EPNL_R$ , when calculated according to the simplified method described in 8.3, is greater than the maximum noise levels prescribed in 3.4 of Part II, Chapter 3, less 1 EPNdB.

*Note.— Part II, Chapter 3, 3.7.6, specifies limitations regarding the validity of test data based upon both the extent to which  $EPNL_R$  differs from EPNL, and also the proximity of the final  $EPNL_R$  values to the maximum permitted noise levels, regardless of the method used for adjustment.*

## 8.3 Simplified method of adjustment

### 8.3.1 General

8.3.1.1 The simplified adjustment method consists of the determination and application of adjustments to the EPNL calculated from the measured data for the differences between measured and reference conditions at the moment of PNLTM. The adjustment terms are:

- a)  $\Delta_1$  — adjustment for differences in the PNLTM spectrum under test and reference conditions (see 8.3.2);
- b)  $\Delta_{\text{peak}}$  — adjustment for when the PNLT for a secondary peak, identified in the calculation of EPNL from measured data and adjusted to reference conditions, is greater than the PNLT for the adjusted PNLTM spectrum (see 8.3.3);
- c)  $\Delta_2$  — adjustment for the difference in noise duration, taking into account the differences between test and reference aircraft speed and position relative to the microphone (see 8.3.4); and
- d)  $\Delta_3$  — adjustment for differences in source noise generating mechanisms (see 8.3.5).

8.3.1.2 The coordinates (time, X, Y and Z) of the reference data point associated with the emission of PNLTM<sub>R</sub> shall be determined such that the sound emission angle  $\theta$  on the reference flight path, relative to the reference microphone, is the same value as the sound emission angle of the as-measured data point associated with PNLTM.

8.3.1.3 The adjustment terms described in 8.3.2 to 8.3.5 are applied to the EPNL calculated from measured data to obtain the simplified reference condition effective perceived noise level, EPNL<sub>R</sub> as described in 8.3.6.

8.3.1.4 Any asymmetry in the lateral noise shall be accounted for in the determination of EPNL as described in 8.3.7.

### 8.3.2 Adjustments to spectrum at PNLTM

8.3.2.1 The one-third octave band levels SPL(*i*) used to construct PNL(*k<sub>M</sub>*) (the PNL at the moment of PNLTM observed at measurement point K) shall be adjusted to reference levels SPL<sub>R</sub>(*i*) as follows:

$$\begin{aligned} \text{SPL}_R(i) = & \text{SPL}(i) + 0.01 [\alpha(i) - \alpha_R(i)] \text{QK} \\ & + 0.01 \alpha_R(i) (\text{QK} - \text{Q}_r\text{K}_r) \\ & + 20 \log (\text{QK}/\text{Q}_r\text{K}_r) \end{aligned}$$

In this expression:

- the term  $0.01 [\alpha(i) - \alpha_R(i)] \text{QK}$  accounts for the effect of the change in sound attenuation due to atmospheric absorption, and  $\alpha(i)$  and  $\alpha_R(i)$  are the coefficients for the test and reference atmospheric conditions, respectively, obtained from Section 7;
- the term  $0.01 \alpha_R(i) (\text{QK} - \text{Q}_r\text{K}_r)$  accounts for the effect of the change in the sound propagation path length on the sound attenuation due to atmospheric absorption;
- the term  $20 \log (\text{QK}/\text{Q}_r\text{K}_r)$  accounts for the effect of the change in the sound propagation path length due to spherical spreading (also known as the “inverse square” law);
- QK and  $\text{Q}_r\text{K}_r$  are measured in metres, and  $\alpha(i)$  and  $\alpha_R(i)$  are obtained in the form of dB/100 m.

*Note.*— Refer to Figures A2-10 and A2-11 for identification of positions and distances referred to in this paragraph.

8.3.2.2 The adjusted values of SPL<sub>R</sub>(*i*) obtained in 8.3.2.1 shall be used to calculate a reference condition PNLT value, PNLTR(*k<sub>M</sub>*), as described in 4.2 and 4.3 of this appendix. The value of the bandsharing adjustment,  $\Delta_B$ , calculated for the test-day PNLTM by the method of 4.4.2, shall be added to this PNLTR(*k<sub>M</sub>*) value to obtain the reference condition PNLTM<sub>R</sub>:

$$\text{PNLTM}_R = \text{PNLTR}(k_M) + \Delta_B$$

An adjustment term,  $\Delta_1$ , is then calculated as follows:

$$\Delta_1 = \text{PNLTM}_R - \text{PNLTM}$$

8.3.2.3  $\Delta_1$  shall be added algebraically to the EPNL calculated from measured data as described in 8.3.6.

### 8.3.3 Adjustment for secondary peaks

8.3.3.1 During a test flight any values of PNLT that are within 2 dB of PNLTM are defined as “secondary peaks”. The one-third octave band levels for each “secondary peak” shall be adjusted to reference conditions according to the procedure defined in 8.3.2.1. Adjusted values of PNLTR shall be calculated for each “secondary peak” as described in 4.2 and 4.3 of this appendix. If any adjusted peak value of PNLTR exceeds the value of PNLTM<sub>R</sub>, a  $\Delta_{\text{peak}}$  adjustment shall be applied.

8.3.3.2  $\Delta_{\text{peak}}$  shall be calculated as follows:

$$\Delta_{\text{peak}} = \text{PNLT}_{\text{R}}(k_{M2}) - \text{PNLTM}_{\text{R}}$$

where  $\text{PNLT}_{\text{R}}(k_{M2})$  is the reference condition PNL value of the largest of the secondary peaks; and  $\text{PNLTM}_{\text{R}}$  is the reference condition PNL value at the moment of PNLTM.

8.3.3.3  $\Delta_{\text{peak}}$  shall be added algebraically to the EPNL calculated from measured data as described in 8.3.6.

### 8.3.4 Adjustment for effects on noise duration

8.3.4.1 Whenever the measured flight paths and/or the ground velocities of the test conditions differ from the reference flight paths and/or the reference ground velocities, adjustments to noise duration shall be determined as follows.

8.3.4.2 Referring to the flight paths shown in Figures A2-10 and A2-11, the adjustment term  $\Delta_2$  shall be calculated from the measured data as follows:

$$\Delta_2 = -7.5 \log (QK/Q_K) + 10 \log (V_G/V_{GR})$$

where:

$V_G$  is the test ground speed (horizontal component of the test airspeed); and

$V_{GR}$  is the reference ground speed (horizontal component of the reference airspeed).

*Note.*— The factors,  $-7.5$  and  $10$ , have been determined empirically from a representative sample population of certificated aeroplanes and helicopters. The factors account for the effects of changes in noise duration on EPNL due to distance and speed, respectively.

8.3.4.3  $\Delta_2$  shall be added algebraically to the EPNL calculated from measured data as described in 8.3.6.

### 8.3.5 Source noise adjustments

8.3.5.1 The source noise adjustment shall be applied to take account of differences in test and reference source noise generating mechanisms. For this purpose the effect on aircraft propulsion source noise of differences between the acoustically significant propulsion operating parameters actually realized in the certification flight tests and those calculated or specified for the reference conditions of Chapter 3, 3.6.1.5, is determined. Such operating parameters may include for jet aeroplanes, the engine noise performance parameter  $\mu$  (typically normalized low pressure fan speed, normalized engine thrust or engine pressure ratio), for propeller-driven aeroplanes both shaft horsepower and propeller helical tip Mach number and for helicopters, during overflight only, advancing rotor blade tip Mach number. The adjustment shall be determined from manufacturer's data approved by the certifying authority.

8.3.5.2 For aeroplanes, the adjustment term  $\Delta_3$  shall normally be determined from sensitivity curve(s) of EPNL versus the propulsion operating parameter(s) referred to in 8.3.5.1. It is obtained by subtracting the EPNL value corresponding to the measured value of the correlating parameter from the EPNL value corresponding to the reference value of the correlating parameter. The adjustment term  $\Delta_3$  shall be added algebraically to the EPNL value calculated from the measured data (see 8.3.6).

*Note.*— Representative data for jet aeroplanes are illustrated in Figure A2-12 which shows a curve of EPNL versus the engine noise performance parameter  $\mu$ . The EPNL data is adjusted to all other relevant reference conditions (airplane mass, speed, height and air temperature) and, at each value of  $\mu$ , for the difference in noise between the installed engine and the flight manual standard of engine.

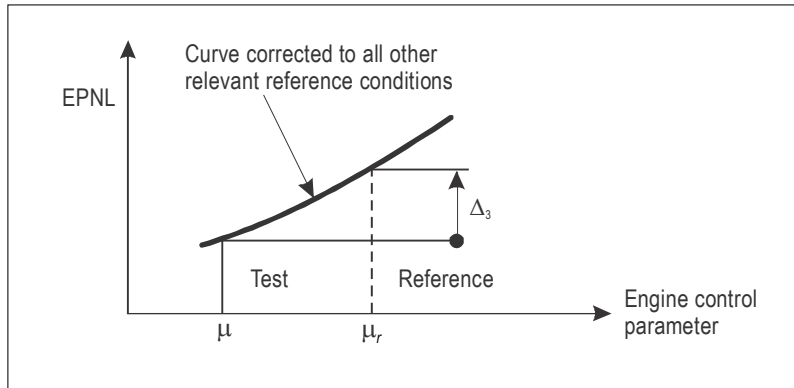

**Figure A2-12. Source noise adjustment**

8.3.5.3 For jet aeroplanes, noise data acquired from measurements conducted at test site locations at or above 366 m (1 200 ft) above mean sea level (MSL) shall, in addition, be adjusted for the effects on jet source noise.

*Note.*— A procedure for determining and applying the adjustment for the effects on jet source noise is given in the section of the Environmental Technical Manual (Doc 9501), Volume I — Procedures for the Noise Certification of Aircraft, concerning noise data adjustments for tests at high altitude sites.

8.3.5.4 For jet aeroplanes, when the test and reference true airspeeds differ by more than 28 km/h (15 kt), the effect of the difference in airspeed on engine component noise sources and the consequential effect on the certification noise levels shall be taken into account. Test data and/or analysis procedures used to quantify this effect shall be approved by the certifying authority.

8.3.5.5 For helicopter overflight, if any combination of the following three factors results in the measured value of an agreed noise correlating parameter deviating from the reference value of this parameter, then source noise adjustments shall be determined from manufacturer's data approved by the certifying authority:

- a) airspeed deviations from reference;
- b) rotor speed deviations from reference; and/or
- c) temperature deviations from reference.

This adjustment should normally be made using a sensitivity curve of  $PNLTM_R$  versus advancing blade tip Mach number. The adjustment may be made using an alternative parameter, or parameters, approved by the certifying authority.

*Note 1.*— If it is not possible during noise measurement tests to attain the reference value of advancing blade tip Mach number or the agreed reference noise correlating parameter, then an extrapolation of the sensitivity curve is permitted, provided the data cover an adequate range of values, agreed by the certifying authority, of the noise correlating parameter. The advancing blade tip Mach number, or agreed noise correlating parameter, shall be computed from as measured data. Separate curves of  $PNLTM_R$  versus advancing blade tip Mach number, or another agreed noise correlating parameter, shall be derived for each of the three certification microphone locations, centre line, left sideline and right sideline, defined relative to the direction of flight of each test run.

*Note 2.*— When using advancing blade tip Mach number it should be computed using true airspeed, on-board outside air temperature (OAT), and rotor speed.

8.3.5.6 For helicopters, the adjustment term  $\Delta_3$ , obtained according to 8.3.5.5, shall be added algebraically to the EPNL value calculated from the measured data as described in 8.3.6.

### 8.3.6 Application of adjustment terms for simplified method

Determine EPNL for reference conditions,  $EPNL_R$ , using the simplified method, by adding the adjustment terms identified in 8.3.2 through 8.3.5 to the EPNL calculated for measurement conditions as follows:

$$EPNL_R = EPNL + \Delta_1 + \Delta_{\text{peak}} + \Delta_2 + \Delta_3$$

### 8.3.7 Lateral noise asymmetry

For the determination of the lateral noise level for jet aeroplanes, asymmetry (see Chapter 3, 3.3.2.2) shall be accounted for as follows:

- if a symmetrical measurement point is opposite the point where the highest noise level is obtained, the certification noise level shall be the (arithmetical) mean of the noise levels measured at these two points (see Figure A2-13 a));
- if not, it shall be assumed that the variation of noise with the height of the aeroplane is the same on both sides (i.e. there is a constant difference of noise versus height on the two sides (see Figure A2-13 b)). The certification noise level shall then be the maximum value of the mean between these lines.

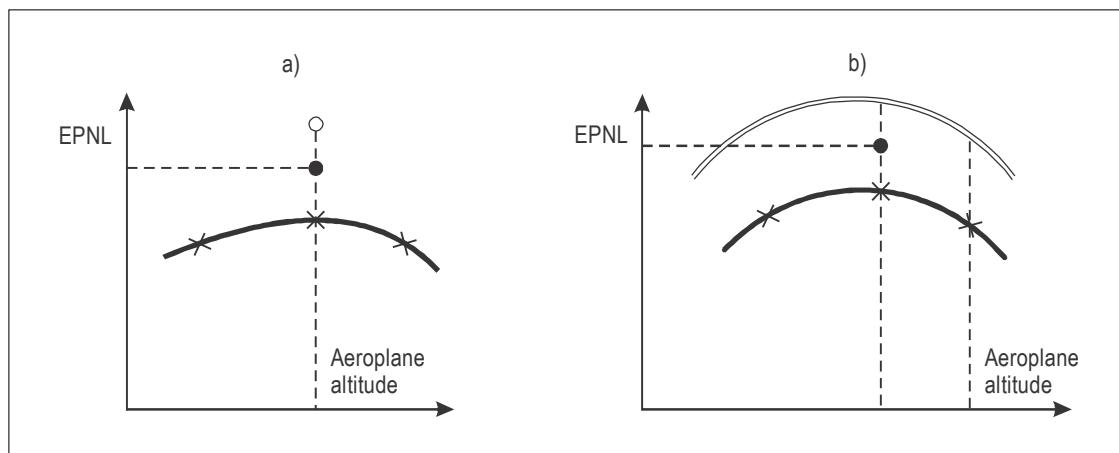

Figure A2-13. Lateral asymmetry adjustments

## 8.4 Integrated method of adjustment

### 8.4.1 General

8.4.1.1 The integrated method consists of recomputing, under reference conditions, points in the PNL time history corresponding to measured points obtained during the tests, and then computing EPNL directly for the new time history.

8.4.1.2 The emission coordinates (time, X, Y, and Z) of the reference data point associated with each  $PNLT_R(k)$  shall be determined such that the sound emission angle  $\theta$  on the reference flight path, relative to the reference microphone, is the same value as the sound emission angle of the as-measured data point associated with  $PNLT(k)$ .

*Note.— As a consequence, and unless the test and reference conditions are identical, the reception time intervals between the reference data points will typically neither be equally-spaced nor equal to one-half second.*

8.4.1.3 The steps in the integrated procedure are as follows:

- a) The spectrum associated with each test-day data point,  $PNLT(k)$ , is adjusted for spherical spreading and attenuation due to atmospheric absorption, to reference conditions (see 8.4.2.1);
- b) A reference tone-corrected perceived noise level,  $PNLT_R(k)$ , is calculated for each one-third octave band spectrum (see 8.4.2.2);
- c) The maximum value,  $PNLTM_R$  and first and last 10 dB-down points are determined from the  $PNLT_R$  series (see 8.4.2.3 and 8.4.3.1);
- d) The effective duration,  $\delta t_R(k)$ , is calculated for each  $PNLT_R(k)$  point, and the reference noise duration is then determined (see 8.4.3.2 and 8.4.3.3);
- e) The integrated reference condition effective perceived noise level,  $EPNL_R$ , is determined by the logarithmic summation of  $PNLT_R(k)$  levels within the noise duration normalized to a duration of 10 seconds (see 8.4.4); and
- f) A source noise adjustment is determined and applied (see 8.4.5).

## 8.4.2 PNL T computations

8.4.2.1 The measured values of  $SPL(i,k)$  shall be adjusted to the reference values  $SPL_R(i,k)$  for the differences between measured and reference sound propagation path lengths and between measured and reference atmospheric conditions, by the methods of 8.3.2.1. Corresponding values of  $PNL_R(k)$  shall be computed as described in 4.2.

8.4.2.2 For each value of  $PNL_R(k)$ , a tone correction factor  $C$  shall be determined by analysing each reference value  $SPL_R(i,k)$  by the methods of 4.3, and added to  $PNL_R(k)$  to obtain  $PNLT_R(k)$ .

8.4.2.3 The maximum reference condition tone corrected perceived noise level,  $PNLTM_R$ , shall be identified, and a new reference condition bandsharing adjustment,  $\Delta_{BR}$ , shall be determined and applied as described in 4.4.2.

*Note.— Due to differences between test and reference conditions, it is possible that the maximum  $PNLT_R$  value will not occur at the data point associated with  $PNLTM$ . The determination of  $PNLTM_R$  is independent of  $PNLTM$ .*

## 8.4.3 Noise duration

8.4.3.1 The limits of the noise duration shall be defined as the 10 dB-down points obtained from the series of reference condition  $PNLT_R(k)$  values. Identification of the 10 dB-down points shall be performed in accordance with 4.5.1. In the case of the integrated method, the first and last 10 dB-down points shall be designated as  $k_{FR}$  and  $k_{LR}$ .

8.4.3.2 The noise duration for the integrated reference condition shall be equal to the sum of the effective durations,  $\delta t_R(k)$ , associated with each of the  $PNLT_R(k)$  data points within the 10 dB-down period, inclusive.

8.4.3.3 The effective duration,  $\delta t_R(k)$ , shall be determined for each  $\text{PNLT}_R(k)$  reference condition data point as follows:

$$\delta t_R(k) = [(t_R(k) - t_R(k-1)) + (t_R(k+1) - t_R(k))] / 2$$

where:

$t_R(k)$  is the time associated with  $\text{PNLT}_R(k)$ ;

$t_R(k-1)$  is the time associated with  $\text{PNLT}_R(k-1)$ , the data point preceding  $\text{PNLT}_R(k)$ ; and

$t_R(k+1)$  is the time associated with  $\text{PNLT}_R(k+1)$ , the data point following  $\text{PNLT}_R(k)$ .

*Note 1.— Due to differences in flight path geometry, airspeed and sound speed between test and reference conditions, the times,  $t_R(k)$ , associated with the  $\text{PNLT}_R(k)$  points projected to the reference flight path are likely to occur at varying, non-uniform time intervals.*

*Note 2.— Relative values of time  $t_R(k)$  for the reference data points can be determined by using the distance between such points on the reference flight path, and the reference aircraft airspeed  $V_R$ .*

*Note 3.— The Environmental Technical Manual (Doc 9501), Volume I — Procedures for the Noise Certification of Aircraft, provides additional guidance for one method for performing the integrated procedure, including the determination of effective durations,  $\delta t_R(k)$ , for the individual data points of the reference time history.*

#### 8.4.4 Calculation of integrated reference condition EPNL

8.4.4.1 The equation for calculating reference condition EPNL using the integrated method,  $\text{EPNL}_R$ , is similar to the equation for test-day EPNL given in 4.6. However, the numerical constant related to one-half second intervals is eliminated, and a multiplier is introduced within the logarithm to account for the effective duration of each  $\text{PNLT}_R(k)$  value,  $\delta t_R(k)$ :

$$\text{EPNL}_R = 10 \log \frac{1}{t_0} \sum_{k_{FR}}^{k_{LR}} 10^{0.1 \text{PNLT}_R(k)} \delta t_R(k)$$

where:

the reference time,  $t_0$ , is 10 seconds;

$k_{FR}$  and  $k_{LR}$  are the first and last 10 dB-down points as defined in 8.4.3.1; and

$\delta t_R(k)$  is the effective duration as defined in 8.4.3.3 of each reference condition  $\text{PNLT}_R(k)$  value.

#### 8.4.5 Source noise adjustment

8.4.5.1 Finally, a source noise adjustment shall be determined by the methods of 8.3.5, and added to the  $\text{EPNL}_R$  determined in 8.4.4.1.



8.4.5.2 For jet aeroplanes, noise data acquired from measurements conducted at test site locations at or above 366 m (1 200 ft) above mean sea level (MSL) shall, in addition, be adjusted for the effects on jet source noise.

*Note.— A procedure for determining the adjustment for the effects on jet source noise is given in the section of the Environmental Technical Manual (Doc 9501), Volume I — Procedures for the Noise Certification of Aircraft, concerning noise data adjustments for test at high altitude sites.*

---



**APPENDIX 3. EVALUATION METHOD FOR NOISE CERTIFICATION  
OF PROPELLER-DRIVEN AEROPLANES NOT EXCEEDING  
8 618 kg — Application for Type Certificate  
submitted before 17 November 1988**

*Note.— See Part II, Chapter 6.*

**1. INTRODUCTION**

*Note 1.— This noise evaluation method includes:*

- a) noise certification test and measurement conditions;*
- b) measurement of aeroplane noise received on the ground; and*
- c) reporting of data to the certifying authority and correction of measured data.*

*Note 2.— The instructions and procedures given in the method are clearly delineated to ensure uniformity during compliance tests, and to permit comparison between tests of various types of aeroplanes, conducted in various geographical locations. The method applies only to aeroplanes within the applicability clauses of Part II, Chapter 6.*

**2. NOISE CERTIFICATION TEST AND  
MEASUREMENT CONDITIONS**

**2.1 General**

This section prescribes the conditions under which noise certification tests shall be conducted and the measurement procedures that shall be used to measure the noise made by the aeroplane for which the test is conducted.

**2.2 General test conditions**

2.2.1 Locations for measuring noise from an aeroplane in flight shall be surrounded by relatively flat terrain having no excessive sound absorption characteristics such as might be caused by thick, matted or tall grass, shrubs or wooded areas. No obstructions which significantly influence the sound field from the aeroplane shall exist within a conical space above the measurement position, the cone being defined by an axis normal to the ground and by a half-angle 75° from this axis.

2.2.2 The tests shall be carried out under the following atmospheric conditions:

- a) no precipitation;

- b) relative humidity not higher than 95 per cent and not lower than 20 per cent and ambient temperature not above 35°C and not below 2°C at 1.2 m (4 ft) above ground except that on a diagram of temperature plotted against relative humidity combinations of temperature and relative humidity which fall below a straight line between 2°C and 60 per cent and 35°C and 20 per cent shall be avoided;
- c) at 1.2 m (4 ft) above ground, instantaneous wind speed shall not exceed 5.1 m/s (10 kt) and instantaneous crosswind speed shall not exceed 2.6 m/s (5 kt). Flights shall be made in equal numbers with tailwind and headwind components; and

*Note.— The noise certification test windows for wind speed expressed in m/s are the result of converting historically used values expressed in knots using a conversion factor consistent with Annex 5, Chapter 3, Table 3-3, and rounded to 0.1 m/s. The values as given here, expressed in either unit, are considered equivalent for establishing adherence to the wind speed test windows for noise certification purposes.*

- d) no temperature inversions or anomalous wind conditions that would significantly affect the noise level of the aeroplane when the noise is recorded at the measuring points specified by the certificating authority.

### 2.3 Aeroplane testing procedures

2.3.1 The test procedures and noise measurement procedure shall be acceptable to the airworthiness and noise certificating authorities of the State issuing the certification.

2.3.2 The aeroplane height and lateral position relative to the microphone shall be determined by a method independent of normal flight instrumentation, such as radar tracking, theodolite triangulation, photographic scaling techniques, or other methods to be approved by the certificating authority.

## 3. MEASUREMENT OF AEROPLANE NOISE RECEIVED ON THE GROUND

### 3.1 General

3.1.1 All measuring equipment shall be approved by the certificating authority.

3.1.2 Sound pressure level data for noise evaluation purposes shall be obtained with acoustical equipment and measurement practices that conform to the specifications given hereunder in 3.2.

### 3.2 Measurement system

The acoustical measurement system shall consist of approved equipment equivalent to the following:

- a) a microphone system with frequency response compatible with measurement and analysis system accuracy as stated in 3.3;
- b) tripods or similar microphone mountings that minimize interference with the sound being measured;

- c) recording and reproducing equipment characteristics, frequency response, and dynamic range compatible with the response and accuracy requirements of 3.3; and
- d) acoustic calibrators using sine wave or broadband noise of known sound pressure level. If broadband noise is used, the signal shall be described in terms of its average and maximum root-mean-square (rms) value of non-overload signal level.

### 3.3 Sensing, recording and reproducing equipment

3.3.1 When so specified by the certificating authority, the sound produced by the aeroplane shall be recorded in such a way that the complete information, including time history, is retained. A magnetic tape recorder is acceptable.

3.3.2 The characteristics of the complete system shall comply with the recommendations given in International Electrotechnical Commission (IEC) Publication No. 179<sup>1</sup> with regard to the sections concerning microphone, amplifier and indicating instrument characteristics. The text and specifications of IEC Publication No. 179<sup>1</sup> entitled “Precision Sound Level Meters” are incorporated by reference into this section and are made a part hereof.

*Note.— When a tape recorder is used, it forms part of the complete system complying with IEC Recommendation 561.<sup>1</sup>*

3.3.3 The response of the complete system to a sensibly plane progressive sinusoidal wave of constant amplitude shall lie within the tolerance limits specified in Table IV and Table V for Type I instruments in IEC Publication No. 179,<sup>1</sup> for weighting curve “A” over the frequency range 45 to 11 200 Hz.

3.3.4 The recorded noise signal shall be read through an “A” filter as defined in IEC Publication No. 179,<sup>1</sup> and with dynamic characteristics designated “slow”.

*Note.— During tests with high flight speeds, the “fast” dynamic characteristics may be necessary to obtain the true level.*

3.3.5 The equipment shall be acoustically calibrated using facilities for acoustic free-field calibration. The overall sensitivity of the measuring system shall be checked before and after the measurement of the noise level for a sequence of aeroplane operations, using an acoustic calibrator generating a known sound pressure level at a known frequency.

*Note.— A pistonphone operating at a nominal 124 dB and 250 Hz is generally used for this purpose.*

3.3.6 A windscreen shall be employed with the microphone during all measurements of aeroplane noise when the wind speed is in excess of 3 m/s (6 kt). Its characteristics shall be such that when it is used, the complete system including the windscreen will meet the specifications above. Its insertion loss at the frequency of the acoustic calibrator shall also be known and included in the provision of an acoustic reference level for the analysis of the measurements.

### 3.4 Noise measurement procedures

3.4.1 The microphones shall be oriented in a known direction so that the maximum sound received arrives as nearly as possible in the direction for which the microphones are calibrated. The microphones shall be placed so that their sensing elements are approximately 1.2 m (4 ft) above ground.

3.4.2 Immediately prior to and after each test, a recorded acoustic calibration of the system shall be made in the field with an acoustic calibrator for the two purposes of checking system sensitivity and providing an acoustic reference level for the analysis of the sound level data.

---

1. As amended. Available from the Central Office of the International Electrotechnical Commission, 3 rue de Varembe, Geneva, Switzerland.

3.4.3 Background noise, including ambient noise and electrical noise of the measurement systems, shall be recorded and determined in the test area with the system gain set at levels which will be used for aeroplane noise measurements. If aeroplane sound pressure levels do not exceed background sound pressure levels by at least 10 dB(A), approved corrections for the contribution of background sound pressure level to the observed sound pressure level shall be applied.

#### **4. REPORTING OF DATA TO THE CERTIFICATING AUTHORITY AND CORRECTION OF MEASURED DATA**

##### **4.1 Data reporting**

4.1.1 Measured and corrected sound pressure levels obtained with equipment conforming to the specifications described in Section 3 of this appendix shall be reported.

4.1.2 The type of equipment used for measurement and analysis of all acoustic aeroplane performance and meteorological data shall be reported.

4.1.3 The following atmospheric environmental data, measured immediately before, after, or during each test at the observation points prescribed in Section 2 of this appendix shall be reported:

- a) air temperature and relative humidity; and
- b) maximum, minimum and average wind velocities.

4.1.4 Comments on local topography, ground cover, and events that might interfere with sound recordings shall be reported.

4.1.5 The following aeroplane information shall be reported:

- a) type, model and serial numbers of aeroplane, engine(s) and propeller(s);
- b) any modifications or non-standard equipment likely to affect the noise characteristics of the aeroplane;
- c) maximum certificated take-off mass;
- d) for each overflight, airspeed and air temperature at the flyover altitude determined by properly calibrated instruments;
- e) for each overflight, engine performance as manifold pressure or power, propeller speed in revolutions per minute and other relevant parameters determined by properly calibrated instruments;
- f) aeroplane height above ground (see 2.3.2);
- g) corresponding manufacturer's data for the reference conditions relevant to 4.1.5 d) and e).

##### **4.2 Data correction**

###### **4.2.1 Correction of noise at source**

4.2.1.1 When so specified by the certificating authority, corrections for differences between engine power achieved during the tests and the power that would be achieved at settings corresponding to the highest power in the normal operating range by an average engine of the type under reference conditions shall be applied using approved methods.

4.2.1.2 At a propeller helical tip Mach number at or below 0.70 no correction is required if the test helical tip Mach number is within 0.014 of the reference helical tip Mach number. At a propeller helical tip Mach number above 0.70 and at or below 0.80 no correction is required if the test helical tip Mach number is within 0.007 of the reference helical tip Mach number. Above a helical tip Mach number of 0.80 no correction is required if the helical tip Mach number is within 0.005 of the reference helical tip Mach number. If the test power at any helical tip Mach number is within 10 per cent of the reference power, no correction for source noise variation with power is required. No corrections are to be made for power changes for fixed pitch propeller-driven aeroplanes. If test propeller helical tip Mach number and power variations from reference conditions are outside these constraints, corrections based on data developed using the actual test aeroplane or a similar configured aeroplane with the same engine and propeller operating as the aeroplane being certificated shall be used as described in the section of the *Environmental Technical Manual* (Doc 9501), Volume I — *Procedures for the Noise Certification of Aircraft*, concerning source noise adjustments for aeroplanes evaluated under this appendix.

#### 4.2.2 Correction of noise received on the ground

The noise measurements made at heights different from 300 m (984 ft) shall be adjusted to 300 m (984 ft) by the inverse square law.

#### 4.2.3 Performance correction

*Note.*— *The performance correction is intended to credit higher performance aeroplanes based on their ability to climb at a steeper angle and to fly the traffic pattern at a lower power setting. Also, this correction penalizes aeroplanes with limited performance capability which results in lower rates of climb and higher power settings in the traffic pattern.*

4.2.3.1 A performance correction determined for sea level, 15°C conditions and limited to a maximum of 5 dB(A) shall be applied using the method described in 4.2.3.2 and added algebraically to the measured value.

4.2.3.2 The performance correction shall be calculated by using the following formula:

$$\Delta\text{dB} = 49.6 - 20 \log \left[ (3\,500 - D_{15}) \frac{\text{Best R/C}}{V_Y} + 15 \right]$$

where  $D_{15}$  = Take-off distance to 15 m at maximum certificated take-off mass and maximum take-off power (paved runway)

Best R/C = Best rate of climb at maximum certificated take-off mass and maximum take-off power

$V_Y$  = Climb speed corresponding to Best R/C at maximum take-off power and expressed in the same units.

*Note.*— *When take-off distance is not certificated, the figure of 610 m for single-engined aeroplanes and 825 m for multi-engined aeroplanes is used.*

### 4.3 Validity of results

4.3.1 The measuring point shall be overflown at least four times. The test results shall produce an average dB(A) value and its 90 per cent confidence limits, the noise level being the arithmetic average of the corrected acoustical measurements for all valid test runs over the measuring point.

4.3.2 The samples shall be large enough to establish statistically a 90 per cent confidence limit not exceeding  $\pm 1.5$  dB(A). No test result shall be omitted from the averaging process, unless otherwise specified by the certificating authority.

*Note.— Methods for calculating the 90 per cent confidence interval are given in the section of the Environmental Technical Manual (Doc 9501), Volume I — Procedures for the Noise Certification of Aircraft, concerning calculation of confidence intervals.*

---



# APPENDIX 4. EVALUATION METHOD FOR NOISE CERTIFICATION OF HELICOPTERS NOT EXCEEDING 3 175 kg MAXIMUM CERTIFICATED TAKE-OFF MASS

*Note.— See Part II, Chapter 11.*

## 1. INTRODUCTION

*Note 1.— This noise evaluation method includes:*

- a) noise certification test and measurement conditions;*
- b) definition of sound exposure level using measured noise data;*
- c) measurement of helicopter noise received on the ground;*
- d) adjustment of flight test results; and*
- e) reporting of data to the certifying authority.*

*Note 2.— The instructions and procedures given in the method are intended to ensure uniformity during compliance tests of various types of helicopters conducted in various geographical locations. The method applies only to helicopters meeting the applicability clauses of Part II, Chapter 11, of this Annex.*

## 2. NOISE CERTIFICATION TEST AND MEASUREMENT CONDITIONS

### 2.1 General

This section prescribes the conditions under which noise certification shall be conducted and the meteorological and flight path measurement procedures that shall be used.

### 2.2 Test environment

2.2.1 The location for measuring noise from the helicopter in flight shall be surrounded by relatively flat terrain having no excessive ground absorption characteristics such as might be caused by thick, matted or tall grass, shrubs or wooded areas. No obstructions which significantly influence the sound field from the helicopter shall exist within a conical space above the test noise measurement position, the cone being defined by an axis normal to the ground and by a half-angle of 80° from this axis.

*Note.— Those people carrying out the measurements could themselves constitute such obstructions.*

2.2.2 The tests shall be carried out under the following atmospheric conditions:

- a) no precipitation;

- b) relative humidity not higher than 95 per cent or lower than 20 per cent and ambient temperature not above 35°C and not below 2°C at a height between 1.2 m (4 ft) and 10 m (33 ft) above ground; combinations of temperature and humidity which lead to an absorption coefficient in the 8 KHz one-third octave band of greater than 10 dB/100 m shall be avoided;

*Note.*— Absorption coefficients as a function of temperature and relative humidity are given in Section 7 of Appendix 2 or SAE ARP 866A.

- c) at a height between 1.2 m (4 ft) and 10 m (33 ft) above ground, average wind speed shall not exceed 5.1 m/s (10 kt) and the average crosswind component shall not exceed 2.6 m/s (5 kt); and

*Note.*— The noise certification test windows for wind speed expressed in m/s are the result of converting historically used values expressed in knots using a conversion factor consistent with Annex 5, Chapter 3, Table 3-3, and rounded to 0.1 m/s. The values as given here, expressed in either unit are considered equivalent for establishing adherence to the wind speed test windows for noise certification purposes.

- d) no other anomalous meteorological conditions that would significantly affect the noise level when recorded at the measuring points specified by the certifying authority.

*Note.*— Meteorological specifications are given in Section 2.2.2.1 of Appendix 2.

2.2.3 The atmospheric conditions shall be measured within 2 000 m (6 562 ft) from the microphone locations and shall be representative of the conditions existing over the geographical area in which noise measurements are made.

### 2.3 Flight path measurement

2.3.1 The helicopter spatial position relative to the measurement microphone shall be determined by a method which is approved by the certifying authority and is independent of cockpit flight instrumentation.

*Note.*— Guidance material on aircraft position measurement systems is provided in the Environmental Technical Manual (Doc 9501), Volume I — Procedures for the Noise Certification of Aircraft.

2.3.2 Position and performance data required to make the adjustments referred to in Section 5 of this appendix shall be recorded at an approved sampling rate. Measuring equipment shall be approved by the certifying authority.

### 2.4 Flight test conditions

2.4.1 The helicopter shall be flown in a stabilized flight condition over a distance sufficient to ensure that the time-varying sound level is measured during the entire time period that the sound level is within 10 dB(A) of  $L_{ASmax}$ .

*Note.*—  $L_{ASmax}$  is defined as the maximum of the A-frequency-weighted S-time-weighted sound level measured during the test run.

2.4.2 The helicopter flyover noise test shall be conducted at the airspeed referred to in Part II, Chapter 11, 11.5.2, with such airspeed adjusted as necessary to produce the same advancing blade tip Mach number as associated with the reference conditions.

2.4.3 The reference advancing blade tip Mach number,  $M_{ATR}$ , is defined as the ratio of the arithmetic sum of the reference blade tip rotational speed,  $V_{tipR}$ , and the reference helicopter true airspeed,  $V_R$ , divided by the reference speed of sound,  $c_R$  at 25°C such that:

$$M_{ATR} = \frac{(V_{tipR} + V_R)}{c_R}$$

### 3. NOISE UNIT DEFINITION

3.1 The sound exposure level,  $L_{AE}$ , is defined as the level, in decibels, of the time integral of squared A-weighted sound pressure,  $p_A$ , over a given time period or event, with reference to the square of the standard reference sound pressure,  $p_0$ , of 20  $\mu$ Pa and a reference duration of one second.

3.2 This unit is defined by the expression:

$$L_{AE} = 10 \log \frac{1}{t_0} \int_{t_1}^{t_2} \left( \frac{p_A(t)}{p_0} \right)^2 dt$$

where  $t_0$  is the reference integration time of one second and  $(t_2 - t_1)$  is the integration time interval.

3.3 The above integral can be approximated from periodically sampled measurement as:

$$L_{AE} = 10 \log \frac{1}{t_0} \sum_{k_F}^{k_L} 10^{0.1L_{AS}(k)} \Delta t$$

where  $L_{AS}(k)$  is the time varying A-frequency-weighted S-time-weighted sound level measured at the  $k$ -th instant of time,  $k_F$  and  $k_L$  are the first and last increment of  $k$ , and  $\Delta t$  is the time increment between samples.

3.4 The integration time  $(t_2 - t_1)$  in practice shall not be less than the 10 dB-down period during which  $L_{AS}(t)$  first rises to 10 dB(A) below its maximum value and last falls below 10 dB(A) of its maximum value.

## 4. MEASUREMENT OF HELICOPTER NOISE RECEIVED ON THE GROUND

### 4.1 General

4.1.1 All measuring equipment shall be approved by the certificating authority.

4.1.2 Sound pressure level data for noise evaluation purposes shall be obtained with acoustical equipment and measurement practices that conform to the specifications given in 4.2.

## 4.2 Measurement system

The acoustical measurement system shall consist of approved equipment equivalent to the following:

- a) a microphone system with performance characteristics meeting the requirements of 4.3;
- b) tripods or similar microphone mountings that minimize interference with the sound being measured;
- c) recording and reproducing equipment with performance characteristics meeting the requirements of 4.3; and
- d) sound calibrators using sine wave signals of known sound pressure level meeting the requirements of 4.3.

## 4.3 Sensing, recording and reproducing equipment

4.3.1 The microphone shall be of the type that has a pressure or a diffuse-field sensitivity whose frequency response is nearly flat at grazing incidence.

4.3.2 The  $L_{AE}$  may be directly determined from an integrating sound level meter. Alternatively, with the approval of the certificating authority the sound pressure signal produced by the helicopter may be stored on an analogue magnetic tape recorder or a digital audio recorder for later evaluation using an integrating sound level meter. The  $L_{AE}$  may also be calculated from one-third octave band data obtained from measurements made in conformity with Section 3 of Appendix 2 and using the equation given in 3.3. In this case each one-third octave band sound pressure level shall be weighted in accordance with the A-weighting values given in IEC Publication 61672-1.<sup>1</sup>

4.3.3 The characteristics of the complete system with regard to directional response, frequency weighting A, time weighting S (slow), level linearity, and response to short-duration signals shall comply with the class 1 specifications given in IEC 61672-1.<sup>1</sup> The complete system may include tape recorders or digital audio recorders according to IEC 61672-1.<sup>1</sup>

*Note.— The certificating authority may approve the use of equipment compliant with class 2 of the current IEC standard, or the use of equipment compliant with class 1 or Type 1 specifications of an earlier standard, if the applicant can show that the equipment had previously been approved for noise certification use by a certificating authority. This includes the use of a sound level meter and graphic level recorder to approximate  $L_{AE}$  using the equation given in 3.3. The certificating authority may also approve the use of magnetic tape recorders that comply with the specifications of the older IEC 561 standard if the applicant can show that such use had previously been approved for noise certification use by a certificating authority.*

4.3.4 The overall sensitivity of the measurement system shall be checked before the start of testing, after testing has ended and at intervals during testing using a sound calibrator generating a known sound pressure level at a known frequency. The sound calibrator shall conform to the class 1 requirements of IEC 60942.<sup>2</sup> The output of the sound calibrator shall have been checked by a standardizing laboratory within 6 months of each aircraft noise measurement. Tolerable changes in output shall be not more than 0.2 dB. Measured aircraft noise data shall not be considered valid for certification purposes unless preceded and succeeded by valid sound pressure level calibrations. The measurement system shall be considered satisfactory if the difference between the acoustical sensitivity levels recorded immediately before and immediately after each group of aircraft noise measurements on a given day is not greater than 0.5 dB.

---

1. IEC 61672-1: 2002 entitled “Electroacoustics — Sound level meters — Part I: Specifications”. This IEC publication may be obtained from the Bureau central de la Commission électrotechnique internationale, 3 rue de Varembe, Geneva, Switzerland.

2. IEC 60942: 2003 entitled “Electroacoustics — Sound calibrators”. This IEC publication may be obtained from the Bureau central de la Commission électrotechnique internationale, 3 rue de Varembe, Geneva, Switzerland.

*Note.*— The certifying authority may approve the use of calibrators compliant with class 2 of the current IEC standard, or the use of calibrators compliant with class 1 of an earlier standard, if the applicant can show that the calibrator had previously been approved for noise certification use by a certifying authority.

4.3.5 When the sound pressure signals from the helicopter are recorded, the  $L_{AE}$  may be determined by playback of the recorded signals into the electrical input facility of an approved sound level meter that conforms to the class 1 performance requirements of IEC 61672-1.<sup>3</sup> The acoustical sensitivity of the sound level meter shall be established from playback of the associated recording of the signal from the sound calibrator and knowledge of the sound pressure level produced in the coupler of the sound calibrator under the environmental conditions prevailing at the time of the recording of the sound from the helicopter.

4.3.6 A windscreen should be employed with the microphone during all measurements of helicopter sound levels. Its characteristics should be such that when it is used, the complete system including the windscreen will meet the specifications in 4.3.3.

#### 4.4 Noise measurement procedures

4.4.1 The microphone shall be mounted with the centre of the sensing element 1.2 m (4 ft) above the local ground surface and shall be oriented for grazing incidence, i.e. with the sensing element substantially in the plane defined by the nominal flight path of the helicopter and the measuring station. The microphone mounting arrangement shall minimize the interference of the supports with the sound to be measured.

4.4.2 If the helicopter sound pressure signal is recorded, the frequency response of the electrical system shall be determined, during each test series, at a level within 10 dB of the full-scale reading used during the tests, utilizing random or pseudo-random pink noise. The output of the noise generator shall have been checked by an approved standards laboratory within six months of the test series, and tolerable changes in the relative output at each one-third octave band shall be not more than 0.2 dB. Sufficient determinations shall be made to ensure that the overall calibration of the system is known for each test.

4.4.3 Where an analogue magnetic tape recorder forms part of the measuring chain, each reel of magnetic tape shall carry 30 s of this electrical calibration signal at its beginning and end for this purpose. In addition, data obtained from tape-recorded signals shall be accepted as reliable only if the level difference in the 10 kHz one-third octave band filtered levels of the two signals is not more than 0.75 dB.

*Note.*— Digital audio recorders typically do not exhibit substantial variation in frequency response or level sensitivity; therefore the pink noise testing described in 4.4.2 is not necessary for digital audio recorders.

4.4.4 The A-frequency-weighted sound level of the background noise, including ambient noise and electrical noise of the measurement systems, shall be determined in the test area with the system gain set at levels which will be used for helicopter noise measurements. If the  $L_{ASmax}$  of each test run does not exceed the A-frequency-weighted sound level of the background noise by at least 15 dB(A), flyovers at an approved lower height may be used and the results adjusted to the reference measurement height by an approved method.

### 5. ADJUSTMENT TO TEST RESULTS

5.1 When certification test conditions differ from the reference conditions, appropriate adjustments shall be made to the measured noise data by the methods of this section.

---

3. IEC 61672-1: 2002 entitled “Electroacoustics — Sound level meters — Part I: Specifications”. This IEC publication may be obtained from the Bureau central de la Commission électrotechnique internationale, 3 rue de Varembe, Geneva, Switzerland.

## 5.2 Corrections and adjustments

5.2.1 The adjustments may be limited to the effects of differences in spherical spreading between the helicopter test flight path and the reference flight path (and between reference and adjusted reference airspeed). No adjustment for the differences in atmospheric attenuation between the test and reference meteorological conditions and between the helicopter test and reference ground speeds need be applied.

5.2.2 The adjustments for spherical spreading and duration may be approximated from:

$$\Delta_1 = 12.5 \log (H/150)$$

where H is the height, in metres, of the test helicopter when directly over the noise measurement point.

5.2.3 The adjustment for the difference between reference airspeed and adjusted reference airspeed is calculated from:

$$\Delta_2 = 10 \log \left( \frac{V_{AR}}{V_R} \right)$$

where  $\Delta_2$  is the quantity in decibels that shall be algebraically added to the measured  $L_{AE}$  noise level to correct for the influence of the adjustment of the reference airspeed on the duration of the measured flyover event as perceived at the noise measurement station.  $V_R$  is the reference airspeed as prescribed under Part II, Chapter 11, 11.5.2, and  $V_{AR}$  is the adjusted reference airspeed as prescribed in 2.4.2 of this appendix.

## 6. REPORTING OF DATA TO THE CERTIFICATING AUTHORITY AND VALIDITY OF RESULTS

### 6.1 Data reporting

6.1.1 Measured and corrected sound pressure levels obtained with equipment conforming to the specifications described in Section 4 of this appendix shall be reported.

6.1.2 The type of equipment used for measurement and analysis of all acoustic helicopter performance and meteorological data shall be reported.

6.1.3 The following atmospheric environmental data, measured immediately before, after, or during each test at the observation point prescribed in Section 2 of this appendix shall be reported:

- a) air temperature and relative humidity;
- b) wind speeds and wind directions; and
- c) atmospheric pressure.

6.1.4 Comments on local topography, ground cover and events that might interfere with sound recording shall be reported.

6.1.5 The following helicopter information shall be reported:

- a) type, model and serial numbers of helicopter, engine(s) and rotor(s);

- b) any modifications or nonstandard equipment likely to affect the noise characteristics of the helicopter;
- c) maximum certificated take-off and landing mass;
- d) indicated airspeed in kilometres per hour (knots) and rotor speed in rpm during each demonstration;
- e) engine performance parameters during each demonstration; and
- f) helicopter height above the ground during each demonstration.

## 6.2 Reporting of noise certification reference conditions

Helicopter position and performance data and noise measurements shall be corrected to the noise certification reference conditions specified in Part II, Chapter 11, 11.5. These conditions, including reference parameters, procedures and configurations shall be reported.

## 6.3 Validity of results

6.3.1 The measuring point shall be overflown at least six times. The test results shall produce an average  $L_{AE}$  and its 90 per cent confidence limits, the noise level being the arithmetic average of the corrected acoustical measurements for all valid test runs over the measuring point for the reference procedure.

6.3.2 The sample shall be large enough to establish statistically a 90 per cent confidence limit not exceeding  $\pm 1.5$  dB(A). No test results shall be omitted from the averaging process unless approved by the certificating authority.

*Note.— Methods for calculating the 90 per cent confidence interval are given in the section of the Environmental Technical Manual (Doc 9501), Volume I — Procedures for the Noise Certification of Aircraft concerning the calculation of confidence intervals.*





## APPENDIX 5. MONITORING AIRCRAFT NOISE ON AND IN THE VICINITY OF AERODROMES

*Note.— See Part III.*

### 1. INTRODUCTION

*Note 1.— The introduction of jet aircraft operations, as well as the general increase in air traffic, has resulted in international concern over aircraft noise. To facilitate international collaboration on the solution of aircraft noise problems, it is desirable to recommend a procedure for monitoring aircraft noise on and in the vicinity of aerodromes.*

*Note 2.— In this appendix monitoring is understood to be the routine measurement of noise levels created by aircraft in the operation of an aerodrome. Monitoring usually involves a large number of measurements per day, from which an immediate indication of the noise level may be required.*

*Note 3.— This appendix specifies the measuring equipment to be used in order to measure noise levels created by aircraft in the operation of an aerodrome. The noise levels measured according to this appendix are approximations to perceived noise levels, PNL, in PNdB, as calculated by the method described in Appendix 1, 4.2.*

Monitoring of aircraft noise should be carried out either with mobile equipment, often using only a sound level meter, or with permanently installed equipment incorporating one or more microphones with amplifiers located at different positions in the field with a data transmission system linking the microphones to a central recording installation. This appendix describes primarily the latter method, but specifications given in this appendix should also be followed, to the extent the specifications are relevant, when using mobile equipment.

### 2. DEFINITION

Monitoring of aircraft noise is defined as the routine measurement of noise levels created by aircraft on and in the vicinity of aerodromes for the purpose of monitoring compliance with and checking the effectiveness of noise abatement requirements.

### 3. MEASUREMENT EQUIPMENT

3.1 The measurement equipment should consist of either portable recording apparatus capable of direct reading, or apparatus located at one or more fixed positions in the field linked through a radio transmission — or cable system (e.g. telephone line) to a centrally located recording device.

3.2 The characteristics of the field equipment, including the transmission system, should comply with IEC Publication No. 179,<sup>1</sup> “Precision Sound Level Meters”, except that frequency weighting equal to the inverse of the 40 noy contour

---

1. This publication was first issued in 1965 by the Central Office of the International Electrotechnical Commission, 3 rue de Varembé, Geneva, Switzerland.

(see Figure A5-1) should apply. An approximation, to the nearest decibel, of the inverse of the 40 noy contour relative to the value at 1 000 Hz is given in Table A5-1. The relative frequency response of the weighting element of the equipment should be maintained within a tolerance of  $\pm 0.5$  dB. When such a weighting network is incorporated in a direct-reading instrument, the relation between the acoustical input to the microphone and the meter reading should follow the inverse of the 40 noy contour with the same tolerances as those specified for weighting curve C in IEC Publication No. 179.<sup>2</sup> Measurements obtained by means of the instrumentation described above provide, after adding 7 dB, values which are approximations to the perceived noise levels in PNdB.

3.3 An alternative method of determining approximations to the perceived noise levels can be obtained from measuring the noise using a sound-level meter incorporating the A-weighting network<sup>3</sup> and adding a correction K normally between 9 and 14 dB dependent on the frequency spectrum of the noise. The value of K and the method used by the measuring authorities for determination of that value should be specified when reporting results.

3.4 The field installation of microphones for aircraft noise monitoring purposes should provide for suitable protection of the microphones from rain, snow and other adverse weather conditions. Adequate correction for any insertion loss, as a function of frequency and weather conditions, produced by windscreens or other protective enclosures should be applied to the measured data.

*Note.— Where a record of the noise as a function of time is required this can be obtained by recording the noise signal on a magnetic tape, a graphic level recorder or other suitable equipment.*

3.5 The recording and indicating equipment should comply with IEC Publication No. 179<sup>2</sup> regarding the dynamic characteristics of the indicating instrument designated as “slow”.

*Note.— If the anticipated duration of the noise signal is less than 5 s, the dynamic characteristics designated as “fast” may be used. For the purpose of this note, the duration is described as the length of the significant time history during which the recorded signal, passed through a weighting network having an amplitude characteristic equal to the inverse 40 noy contour, remains within 10 dB of its maximum value.*

3.6 The microphone system should have been originally calibrated at a laboratory equipped for free-field calibration and its calibration should be rechecked at least every six months.

**Table A5-1. Approximation to the nearest decibel of the inverse of the 40 noy contour relative to the value at 1 000 Hz**

Hz	40	50	63	80	100	125	160
dB	-14	-12	-11	-9	-7	-6	-5
Hz	200	250	315	400	500	630	800
dB	-3	-2	-1	0	0	0	0
Hz	1 000	1 250	1 600	2 000	2 500	3 150	4 000
dB	0	+2	+6	+8	+10	+11	+11
Hz	5 000	6 300	8 000	10 000	12 500		
dB	+10	+9	+6	+3	0		

2. This publication was first issued in 1965 by the Central Office of the International Electrotechnical Commission, 3 rue de Varembe, Geneva, Switzerland.

3. The A-weighting network is described in IEC Publication No. 179.

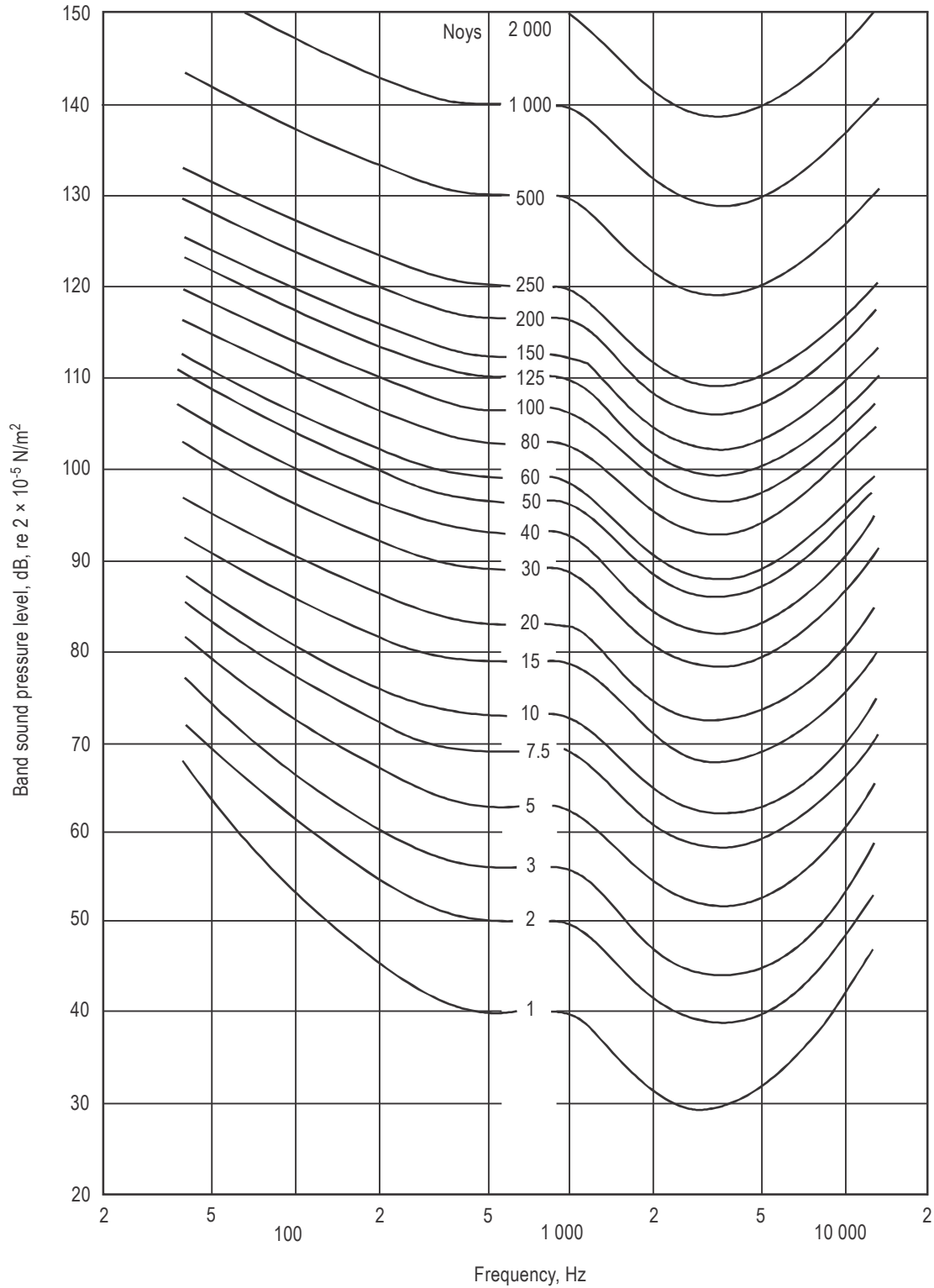

Figure A5-1. Contours of perceived noisiness

3.7 The complete measurement system prior to field installation and at periodic intervals thereafter should be calibrated in a laboratory to ensure that the frequency response and dynamic range requirements of the system comply with the specifications described in this document.

*Note.— Direct-reading measuring systems that yield approximate values of perceived noise levels other than those defined above are not meant to be excluded from use in monitoring.*

#### 4. FIELD EQUIPMENT INSTALLATION

4.1 Microphones used for monitoring noise levels from aircraft operations should be installed at appropriate locations with the axis of maximum sensitivity of each microphone oriented in a direction such that the highest sensitivity to sound waves is achieved. The microphone position should be selected so that no obstruction which influences the sound field produced by an aircraft exists above a horizontal plane passing through the active centre of the microphone.

*Note 1.— Monitoring microphones may need to be placed in locations having substantial background noise levels caused by motor vehicle traffic, children playing, etc. In these instances it is often expedient to locate the microphone on a rooftop, telephone pole or other structure rising above the ground. Consequently, it is necessary to determine the background noise level and to carry out a field check, at one or more frequencies, of the overall sensitivity of the measuring system after or before the measurement of the noise level for a sequence of aircraft operations.*

*Note 2.— If, due to the microphone being placed in a structure above the ground, it is impracticable for operating personnel to calibrate it directly because of its inaccessibility, it can be useful to provide a calibrated sound source at the microphone location. This sound source can be a small loudspeaker, an electrostatic actuator, or similar device.*

4.2 Monitoring concerns the noise produced by a single aircraft flight, by a series of flights or by a specified type of aircraft, or by a large number of operations of different aircraft. Such noise levels vary, for a specific monitoring location, with variations in flight procedures or meteorological conditions. In interpretation of the results of a monitoring procedure, consideration should therefore be given to the statistical distribution of the measured noise levels. In describing the results of a monitoring procedure an appropriate description of the distribution of the observed noise levels should be provided.

**APPENDIX 6. EVALUATION METHOD FOR NOISE  
CERTIFICATION OF PROPELLER-DRIVEN AEROPLANES  
NOT EXCEEDING 8 618 kg — Application for Type Certificate  
or Certification of Derived Version submitted  
on or after 17 November 1988**

*Note.— See Part II, Chapter 10.*

**1. INTRODUCTION**

*Note 1.— This noise evaluation method includes:*

- a) noise certification test and measurement conditions;*
- b) noise unit;*
- c) measurement of aeroplane noise received on the ground;*
- d) adjustments to test data; and*
- e) reporting of data to the certifying authority and validity of results.*

*Note 2.— The instructions and procedures given in the method are clearly delineated to ensure uniformity during compliance tests and to permit comparison between tests of various types of aeroplanes, conducted in various geographical locations. The method applies only to aeroplanes within the applicability clauses of Part II, Chapter 10.*

**2. NOISE CERTIFICATION TEST AND MEASUREMENT CONDITIONS**

**2.1 General**

This section prescribes the conditions under which noise certification tests shall be conducted and the measurement procedures that shall be used to measure the noise made by the aeroplane for which the test is conducted.

**2.2 General test conditions**

2.2.1 Locations for measuring noise from an aeroplane in flight shall be surrounded by relatively flat terrain having no excessive sound absorption characteristics such as might be caused by thick, matted or tall grass, shrubs or wooded areas. No obstructions which significantly influence the sound field from the aeroplane shall exist within a conical space above the measurement position, the cone being defined by an axis normal to the ground and by a half-angle 75° from this axis.

2.2.2 The tests shall be carried out under the following atmospheric conditions:

- a) no precipitation;

- b) relative humidity not higher than 95 per cent and not lower than 20 per cent and ambient temperature not above 35°C and not below 2°C;
- c) average wind speed shall not exceed 5.1 m/s (10 kt) and crosswind average wind speed shall not exceed 2.6 m/s (5 kt);

*Note 1.— Meteorological specifications are defined in Section 2.2.2.1 of Appendix 2.*

*Note 2.— The noise certification test windows for wind speed expressed in m/s are the result of converting historically used values expressed in knots using a conversion factor consistent with Annex 5, Chapter 3, Table 3-3, and rounded to 0.1 m/s. The values as given here, expressed in either unit are considered equivalent for establishing adherence to the wind speed test windows for noise certification purposes.*

- d) no other anomalous meteorological conditions that would significantly affect the noise level of the aeroplane when the noise is recorded at the measuring points specified by the certificating authority; and
- e) the meteorological measurements shall be made between 1.2 m and 10 m above ground level. If the measurement site is within 2 000 m of an airport meteorological station, measurements from this station may be used.

2.2.3 The atmospheric conditions shall be measured within 2 000 m (6 562 ft) from the microphone locations and shall be representative of the conditions existing over the geographical area in which noise measurements are made.

### 2.3 Aeroplane testing procedures

2.3.1 The test procedures and noise measurement procedure shall be approved by the certificating authority.

2.3.2 The flight test programme shall be initiated at the maximum take-off mass for the aeroplane, and the mass shall be adjusted to maximum take-off mass after each hour of flight time.

2.3.3 The flight test shall be conducted at  $V_Y \pm 9$  km/h ( $V_Y \pm 5$  kt) indicated airspeed.

2.3.4 The aeroplane spatial position relative to the measurement microphone shall be determined by a method approved by the certificating authority and is independent of cockpit flight instrumentation.

*Note.— Guidance material on aircraft position measurement systems is provided in the Environmental Technical Manual (Doc 9501), Volume I— Procedures for the Noise Certification of Aircraft.*

2.3.5 The aeroplane height when over the microphone shall be measured by an approved technique. The aeroplane shall pass over the microphone within  $\pm 10^\circ$  from the vertical and within  $\pm 20$  per cent of the reference height (see Figure A6-1).

2.3.6 Aeroplane speed, position and performance data required to make the adjustments referred to in Section 5 of this appendix shall be recorded when the aeroplane is directly over the measurement site. Measuring equipment shall be approved by the certificating authority.

2.3.7 An independent device accurate to within  $\pm 1$  per cent shall be used for the measurement of propeller rotational speed to avoid orientation and installation errors when the test aeroplane is equipped with mechanical tachometers.

## 3. NOISE UNIT DEFINITION

The  $L_{ASmax}$  is defined as the maximum level, in decibels, of the A-weighted sound pressure (slow response) with reference to the square of the standard reference sound pressure ( $p_0$ ) of 20 micropascals ( $\mu Pa$ ).

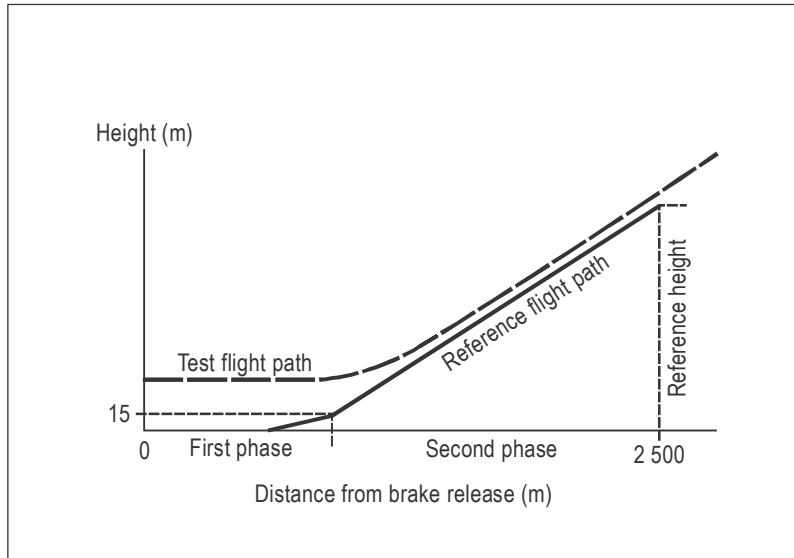

**Figure A6-1. Typical test and reference profiles**

## 4. MEASUREMENT OF AEROPLANE NOISE RECEIVED ON THE GROUND

### 4.1 General

4.1.1 All measuring equipment shall be approved by the certificating authority.

4.1.2 Sound pressure level data for noise evaluation purposes shall be obtained with acoustical equipment and measurement practices that conform to the specifications given hereunder in 4.2.

### 4.2 Measurement system

The acoustical measurement system shall consist of approved equipment equivalent to the following:

- a) a microphone system designed to have mostly-uniform frequency response for sound incident on the diaphragm from random directions, or in the pressure field of a closed cavity, with performance characteristics meeting the requirements of 4.3;
- b) microphone installation and mounting hardware that minimizes interference with the sound being measured, in the configuration specified in 4.4;
- c) recording and reproducing equipment performance characteristics meeting the requirements of 4.3; and
- d) sound calibrators using sine wave signals of known sound pressure level meeting the requirements of 4.3.

### 4.3 Sensing, recording and reproducing equipment

4.3.1 The sound level produced by the aeroplane shall be recorded. A magnetic tape recorder, graphic level recorder or sound level meter is acceptable at the option of the certifying authority.

4.3.2 The characteristics of the complete system with regard to directional response, frequency weighting A, time weighting S (slow), level linearity, and response to short-duration signals shall comply with the class 1 specifications given in the IEC Publication 61672-1.<sup>1</sup> The complete system may include tape recorders according to IEC 61672-1.<sup>1</sup>

*Note.— The certifying authority may approve the use of equipment compliant with class 2 of the current IEC standard, or the use of equipment compliant with class 1 or Type 1 specifications of earlier standards, as an alternative to equipment compliant with class 1 of the current IEC standard, if the applicant can show that the equipment had previously been approved for noise certification use by a certifying authority. The certifying authority may also approve the use of magnetic tape recorders that comply with the specifications of the older IEC 561 standard if the applicant can show that such use had previously been approved for noise certification use by a certifying authority.*

4.3.3 The overall sensitivity of the measurement system shall be checked before the start of testing, after testing has ended, and at intervals during testing using a sound calibrator generating a known sound pressure level at a known frequency. The sound calibrator shall conform to the class 1 requirements of IEC 60942.<sup>2</sup> The output of the sound calibrator shall have been checked by a standardizing laboratory within 6 months of each aircraft noise measurement. Tolerable changes in output shall be not more than 0.2 dB. Measured aircraft noise data shall not be considered valid for certification purposes unless preceded and succeeded by valid sound pressure level calibrations. The measurement system shall be considered satisfactory if the difference between the acoustical sensitivity levels recorded immediately before and immediately after each group of aircraft noise measurements on a given day is not greater than 0.5 dB.

*Note.— The certifying authority may approve the use of calibrators compliant with class 2 of the current IEC standard, or the use of calibrators compliant with class 1 of an earlier standard, if the applicant can show that the calibrator had previously been approved for noise certification use by a certifying authority.*

4.3.4 When the sound from the aeroplane is tape recorded, the maximum A-frequency-weighted and S-time-weighted sound level may be determined by playback of the recorded signals into the electrical input facility of an approved sound level meter that conforms to the class 1 performance requirements of IEC 61672-1.<sup>1</sup> The acoustical sensitivity of the sound level meter shall be established from playback of the associated recording of the signal from the sound calibrator and knowledge of the sound pressure level produced in the coupler of the sound calibrator under the environmental conditions prevailing at the time of the recording of the sound from the aeroplane.

### 4.4 Noise measurement procedures

4.4.1 The microphone shall be a 12.7 mm diameter pressure type, with its protective grid, mounted in an inverted position such that the microphone diaphragm is 7 mm above and parallel to a circular metal plate. This white-painted metal plate shall be 40 cm in diameter and at least 2.5 mm thick, and shall be placed horizontally and flush with the surrounding ground surface with no cavities below the plate. The microphone shall be located three-quarters of the distance from the centre to the edge along a radius normal to the line of flight of the test aeroplane.

4.4.2 If the noise signal is tape-recorded, the frequency response of the electrical system shall be determined, during each test series, at a level within 10 dB of the full-scale reading used during the tests, utilizing random or pseudorandom pink

---

1. IEC 61672-1: 2002 entitled “Electroacoustics — Sound level meters — Part I: Specifications”. This IEC publication may be obtained from the Bureau central de la Commission électrotechnique internationale, 3 rue de Varembe, Geneva, Switzerland.

2. IEC 60942: 2003 entitled “Electroacoustics — Sound calibrators”. This IEC publication may be obtained from the Bureau central de la Commission électrotechnique internationale, 3 rue de Varembe, Geneva, Switzerland.



noise. The output of the noise generator shall have been checked by an approved standards laboratory within six months of the test series, and tolerable changes in the relative output at each one-third octave band shall be not more than 0.2 dB. Sufficient determinations shall be made to ensure that the overall calibration of the system is known for each test.

4.4.3 Where a magnetic tape recorder forms part of the measuring chain, each reel of magnetic tape shall carry 30 s of this electrical calibration signal at its beginning and end for this purpose. In addition, data obtained from tape-recorded signals shall be accepted as reliable only if the level difference in the 10 kHz one-third octave band filtered levels of the two signals is not more than 0.75 dB.

*Note.— Digital audio recorders typically do not exhibit substantial variation in frequency response or level sensitivity, therefore the pink noise testing described in 4.4.3 is not necessary for digital audio recorders. Design characteristics for digital audio recorders should be compliant with class 1 performance specifications of IEC 61672-1.<sup>3</sup>*

4.4.4 The A-frequency-weighted sound level of the background noise, including ambient noise and electrical noise of the measurement systems, shall be determined in the test area with the system gain set at levels which will be used for aeroplane noise measurements. If the maximum A-frequency-weighted and S-time-weighted sound level of the aeroplane does not exceed the A-frequency-weighted sound level of the background noise by at least 10 dB, a take-off measurement point nearer to the start of roll shall be used and the results adjusted to the reference measurement point by an approved method.

## 5. ADJUSTMENT TO TEST RESULTS

5.1 When certification test conditions differ from the reference conditions, appropriate adjustments shall be made to the measured noise data by the methods of this section.

### 5.2 Corrections and adjustments

5.2.1 The adjustments take account of the effects of:

- a) differences in atmospheric absorption between meteorological test conditions and reference conditions;
- b) differences in the sound propagation path length between the actual aeroplane flight path and the reference flight path;
- c) the change in the helical tip Mach number between test and reference conditions; and
- d) the change in engine power between test and reference conditions.

5.2.2 The noise level under reference conditions,  $L_{ASmaxR}$  shall be obtained by adding increments for each of the above effects to the test day noise level,  $L_{ASmax}$ .

$$L_{ASmaxR} = L_{ASmax} + \Delta_1 + \Delta_2 + \Delta_3 + \Delta_4$$

where

- $\Delta_1$  is the adjustment for sound propagation path lengths;
- $\Delta_2$  is the adjustment for helical tip Mach number;
- $\Delta_3$  is the adjustment for engine power; and
- $\Delta_4$  is the adjustment for the change in atmospheric absorption between test and reference conditions.

3. IEC 61672-1: 2002 entitled “Electroacoustics — Sound level meters — Part I: Specifications”. This IEC publication may be obtained from the Bureau central de la Commission électrotechnique internationale, 3 rue de Varembe, Geneva, Switzerland.

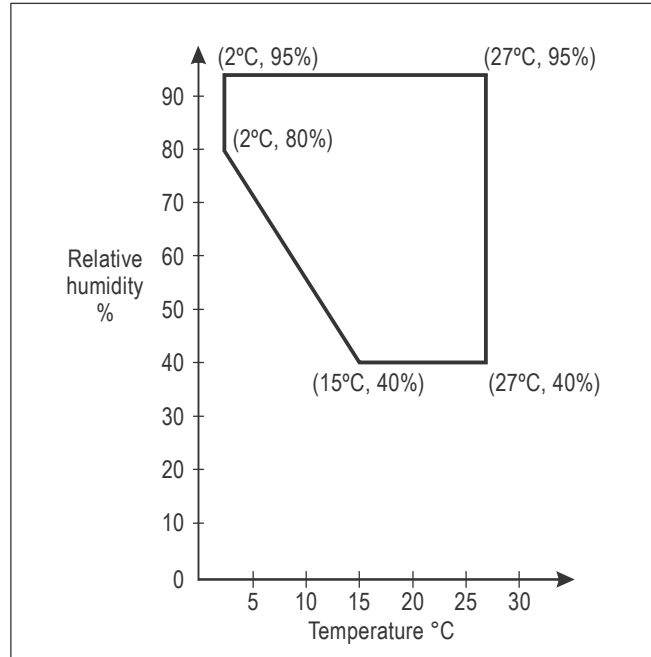

**Figure A6-2. Measurement window for no absorption correction**

- a) When the test conditions are within those specified in Figure A6-2, no adjustments for differences in atmospheric absorption need be applied, i.e.  $\Delta_4 = 0$ . If conditions are outside those specified in Figure A6-2 then adjustments must be applied by an approved procedure or by adding an increment  $\Delta_4$  to the test day noise levels where:

$$\Delta_4 = 0.01 (H \times \alpha_{500} - 0.2 H_R)$$

and where  $H$  is the height in metres of the test aeroplane when directly over the noise measurement point,  $H_R$  is the reference height of the aeroplane above the noise measurement point, and  $\alpha_{500}$  is the rate of absorption at 500 Hz specified in Tables A1-5 to A1-16 of Appendix 1.

- b) Measured noise levels should be adjusted to the height of the aeroplane over the noise measuring point on a reference day by algebraically adding an increment equal to  $\Delta_1$ . When test day conditions are within those specified in Figure A6-2:

$$\Delta_1 = 22 \log (H/H_R)$$

When test day conditions are outside those specified in Figure A6-2:

$$\Delta_1 = 20 \log (H/H_R)$$

where  $H$  is the height of the aeroplane when directly over the noise measurement point, and  $H_R$  is the reference height of the aeroplane over the measurement point.

- c) No adjustments for helical tip Mach number variations need be made if the propeller helical tip Mach number is:
- 1) at or below 0.70 and the test helical tip Mach number is within 0.014 of the reference helical tip Mach number;

- 2) above 0.70 and at or below 0.80 and the test helical tip Mach number is within 0.007 of the reference helical tip Mach number;
- 3) above 0.80 and the test helical tip Mach number is within 0.005 of the reference helical tip Mach number. For mechanical tachometers, if the helical tip Mach number is above 0.8 and the test helical tip Mach number is within 0.008 of the reference helical tip Mach number.

Outside these limits measured noise levels shall be adjusted for helical tip Mach number by an increment equal to:

$$\Delta_2 = k_2 \log (M_{HR}/M_H)$$

which shall be added algebraically to the measured noise level, where  $M_H$  and  $M_{HR}$  are the test and reference helical tip Mach numbers respectively. The value of  $k_2$  shall be determined from approved data from the test aeroplane. In the absence of flight test data and at the discretion of the certificating authority, a value of  $k_2 = 150$  may be used for  $M_H$  less than  $M_{HR}$ ; however, for  $M_H$  greater than or equal to  $M_{HR}$ , no correction is applied.

*Note.*— The reference helical tip Mach number  $M_{HR}$  is the one corresponding to the reference conditions above the measurement point:

where

$$M_{HR} = \frac{\left[ \left( \frac{D\pi N}{60} \right)^2 + V_R^2 \right]^{1/2}}{C_{HR}}$$

where  $D$  is the propeller diameter in metres.

$V_R$  is the true airspeed of the aeroplane in reference conditions in metres per second.

$N$  is the propeller speed in reference conditions in rpm. If  $N$  is not available, its value can be taken as the average of the propeller speeds over nominally identical power conditions during the flight tests.

$c_{HR}$  is the reference day speed of sound at the altitude of the aeroplane in metres per second corresponding to the ambient temperature – assuming a lapse rate of  $0.65^\circ\text{C}$  per 100 m – for a standard day at the aeroplane reference height above mean sea level.

- d) Measured sound levels shall be adjusted for engine power by algebraically adding an increment equal to:

$$\Delta_3 = k_3 \log (P_R/P)$$

where  $P_R$  and  $P$  are the test and reference engine powers respectively obtained from the manifold pressure/torque gauges and engine rpm. The value of  $k_3$  shall be determined from approved data from the test aeroplane. In the absence of flight test data and at the discretion of the certificating authority a value of  $k_3 = 17$  may be used. The reference power  $P_R$  shall be that obtained at the reference height temperature and pressure assuming temperature and pressure lapse rates with height defined by the ICAO Standard Atmosphere.

*Note 1.*— Details for calculating the variation of reference atmospheric temperature and pressure with altitude are given in the section of the Environmental Technical Manual (Doc 9501), Volume I — Procedures for the Noise Certification of Aircraft, concerning the ICAO Standard Atmosphere.

*Note 2.*— The characteristics of the ICAO Standard Atmosphere are provided in the Manual of the ICAO Standard Atmosphere (extended to 80 kilometres (262 500 feet) (Doc 7488/3).

## 6. REPORTING OF DATA TO THE CERTIFICATING AUTHORITY AND VALIDITY OF RESULTS

### 6.1 Data reporting

6.1.1 Measured and corrected sound pressure levels obtained with equipment conforming to the specifications described in Section 4 of this appendix shall be reported.

6.1.2 The type of equipment used for measurement and analysis of all acoustic aeroplane performance and meteorological data shall be reported.

6.1.3 The following atmospheric environmental data, measured immediately before, after, or during each test at the observation points prescribed in Section 2 of this appendix shall be reported:

- a) air temperature and relative humidity;
- b) wind speeds and wind directions; and
- c) atmospheric pressure.

6.1.4 Comments on local topography, ground cover and events that might interfere with sound recordings shall be reported.

6.1.5 The following aeroplane information shall be reported:

- a) type, model and serial numbers of aeroplane, engine(s) and propeller(s);
- b) any modifications or non-standard equipment likely to affect the noise characteristics of the aeroplane;
- c) maximum certificated take-off mass;
- d) for each overflight, airspeed and air temperature at the flyover altitude determined by properly calibrated instruments;
- e) for each overflight, engine performance as manifold pressure or power, propeller speed in revolutions per minute and other relevant parameters determined by properly calibrated instruments;
- f) aeroplane height above the measurement point; and
- g) corresponding manufacturer's data for the reference conditions relevant to 6.1.5 d), e) and f).

### 6.2 Validity of results

6.2.1 The measuring point shall be overflown at least six times. The test results shall produce an average noise level value,  $L_{ASmax}$ , and its 90 per cent confidence limits, the noise level being the arithmetic average of the corrected acoustical measurements for all valid test runs over the measuring point.

6.2.2 The samples shall be large enough to establish statistically a 90 per cent confidence limit not exceeding  $\pm 1.5$  dB(A). No test results shall be omitted from the averaging process, unless otherwise specified by the certificating authority.

## ATTACHMENTS TO ANNEX 16, VOLUME I

### ATTACHMENT A. EQUATIONS FOR THE CALCULATION OF MAXIMUM PERMITTED NOISE LEVELS AS A FUNCTION OF TAKE-OFF MASS

*Note.— See Part II, 2.4.1, 2.4.2, 3.4.1, 4.4, 5.4, 6.3, 8.4.1, 8.4.2, 10.4, 11.4.1, 11.4.2, 13.4 and 14.4.1.*

#### 1. CONDITIONS DESCRIBED IN CHAPTER 2, 2.4.1

M = Maximum take-off mass in 1 000 kg	0	34		272
Lateral noise level (EPNdB)	102		$91.83 + 6.64 \log M$	108
Approach noise level (EPNdB)	102		$91.83 + 6.64 \log M$	108
Flyover noise level (EPNdB)	93		$67.56 + 16.61 \log M$	108

#### 2. CONDITIONS DESCRIBED IN CHAPTER 2, 2.4.2

M = Maximum take-off mass in 1 000 kg	0	34	35	48.3	66.72	133.45	280	325	400
Lateral noise level (EPNdB) All aeroplanes	97						$83.87 + 8.51 \log M$		106
Approach noise level (EPNdB) All aeroplanes	101						$89.03 + 7.75 \log M$		108
Flyover noise levels (EPNdB)	2 engines		93				$70.62 + 13.29 \log M$		104
	3 engines	93			$67.56 + 16.61 \log M$		$73.62 + 13.29 \log M$		107
	4 engines	93			$67.56 + 16.61 \log M$		$74.62 + 13.29 \log M$		108

#### 3. CONDITIONS DESCRIBED IN CHAPTER 3, 3.4.1

M = Maximum take-off mass in 1 000 kg	0	20.2	28.6	35	48.1		280	385	400
Lateral full-power noise level (EPNdB) All aeroplanes	94						$80.87 + 8.51 \log M$		103
Approach noise level (EPNdB) All aeroplanes	98						$86.03 + 7.75 \log M$		105
Flyover noise levels (EPNdB)	2 engines or less			89			$66.65 + 13.29 \log M$		101
	3 engines	89					$69.65 + 13.29 \log M$		104
	4 engines or more	89					$71.65 + 13.29 \log M$		106

#### 4. CONDITIONS DESCRIBED IN CHAPTER 4, 4.4

Each of the following conditions shall apply:

$$EPNL_L \leq LIMIT_L; EPNL_A \leq LIMIT_A; \text{ and } EPNL_F \leq LIMIT_F;$$

$$[(LIMIT_L - EPNL_L) + (LIMIT_A - EPNL_A) + (LIMIT_F - EPNL_F)] \geq 10$$

$$[(LIMIT_L - EPNL_L) + (LIMIT_A - EPNL_A)] \geq 2; [(LIMIT_L - EPNL_L) + (LIMIT_F - EPNL_F)] \geq 2; \text{ and}$$

$$[(LIMIT_A - EPNL_A) + (LIMIT_F - EPNL_F)] \geq 2$$

where

$EPNL_L$ ,  $EPNL_A$  and  $EPNL_F$  are, respectively, the noise levels at the lateral, approach and flyover reference noise measurement points when determined, to one decimal place, in accordance with the noise evaluation method of Appendix 2; and

$LIMIT_L$ ,  $LIMIT_A$  and  $LIMIT_F$  are, respectively, the maximum permitted noise levels at the lateral, approach and flyover reference noise measurement points determined, to one decimal place, in accordance with the equations for the conditions described in Chapter 3, 3.4.1 (Condition 3).

#### 5. CONDITIONS DESCRIBED IN CHAPTER 5, 5.4

M = Maximum take-off  
mass in 1 000 kg

	5.7	34.0	358.9	384.7
Lateral noise level (EPNdB)	96	85.83 + 6.64 log M		103
Approach noise level (EPNdB)	98	87.83 + 6.64 log M		105
Flyover noise level (EPNdB)	89	63.56 + 16.61 log M		106

#### 6. CONDITIONS DESCRIBED IN CHAPTER 6, 6.3

M = Maximum take-off  
mass in 1 000 kg

	0	0.6	1.5	8.618
Noise level in dB(A)	68	60 + 13.33 M		80

#### 7. CONDITIONS DESCRIBED IN CHAPTER 8, 8.4.1, AND CHAPTER 13, 13.4

M = Maximum take-off  
mass in 1 000 kg

	0	0.788	80.0
Take-off noise level (EPNdB)	89	90.03 + 9.97 log M	
Approach noise level (EPNdB)	90	91.03 + 9.97 log M	
Overflight noise level (EPNdB)	88	89.03 + 9.97 log M	

**8. CONDITIONS DESCRIBED IN CHAPTER 8, 8.4.2**

M = Maximum take-off  
mass in 1 000 kg

	0	0.788	80.0
Take-off noise level (EPNdB)	86	$87.03 + 9.97 \log M$	106
Approach noise level (EPNdB)	89	$90.03 + 9.97 \log M$	109
Overflight noise level (EPNdB)	84	$85.03 + 9.97 \log M$	104

**9. CONDITIONS DESCRIBED IN CHAPTER 10, 10.4 A) AND 10.4 B)**

10.4 a):

M = Maximum take-off  
mass in 1 000 kg

	0	0.6	1.4	8.618
Noise level in dB(A)	76	$83.23 + 32.67 \log M$	88	

10.4 b):

M = Maximum take-off  
mass in 1 000 kg

	0	0.57	1.5	8.618
Noise level in dB(A)	70	$78.71 + 35.70 \log M$	85	

**10. CONDITIONS DESCRIBED IN CHAPTER 11, 11.4.1**

M = Maximum take-off  
mass in 1 000 kg

	0	0.788	3.175
Noise level in dB(A)	82	$83.03 + 9.97 \log M$	

**11. CONDITIONS DESCRIBED IN CHAPTER 11, 11.4.2**

M = Maximum take-off  
mass in 1 000 kg

	0	1.417	3.175
Noise level in dB(A)	82	$80.49 + 9.97 \log M$	

## 12. CONDITIONS DESCRIBED IN CHAPTER 14, 14.4.1

M = Maximum take-off  
mass in 1 000 kg

	0	2	8.618	20.234	28.615	35	48.125	280	385	400
Lateral full-power noise level (EPNdB) All aeroplanes	88.6	86.03754 + 8.512295 log M		94		80.86511 + 8.50668 log M				103
Approach noise level (EPNdB) All aeroplanes	93.1	90.77481 + 7.72412 log M		98		86.03167 + 7.75117 log M			105	
Flyover noise levels (EPNdB)	2 engines or less	80.6	76.57059 + 13.28771 log M	89		66.64514 + 13.28771 log M			101	
	3 engines			89	69.64514 + 13.28771 log M				104	
	4 engines or more			89	71.64514 + 13.28771 log M			106		

*Note.*— The slope of the limit lines in the lower and higher weight regions are essentially the same. The observed minor differences between the coefficients of the equations defining the slopes of the lateral and approach lines are a consequence of the limits in Chapter 14, Sections 14.4.1.1 and 14.4.1.3, being defined with fixed end-points. For all practical purposes the minor differences between the coefficients are considered to be insignificant.

Each of the following conditions shall apply:

$$(\text{LIMIT}_L - \text{EPNL}_L) \geq 1; (\text{LIMIT}_A - \text{EPNL}_A) \geq 1; \text{ and } (\text{LIMIT}_F - \text{EPNL}_F) \geq 1;$$

$$[(\text{LIMIT}_L - \text{EPNL}_L) + (\text{LIMIT}_A - \text{EPNL}_A) + (\text{LIMIT}_F - \text{EPNL}_F)] \geq 17$$

where

EPNL<sub>L</sub>, EPNL<sub>A</sub> and EPNL<sub>F</sub> are respectively the noise levels at the lateral, approach and flyover reference noise measurement points when determined, to one decimal place, in accordance with the noise evaluation method of Appendix 2; and

LIMIT<sub>L</sub>, LIMIT<sub>A</sub>, and LIMIT<sub>F</sub> are respectively the maximum permitted noise levels at the lateral, approach and flyover reference noise measurement points determined, to one decimal place, in accordance with the equations for the conditions described in Chapter 14, 14.4.1.



## ATTACHMENT B. GUIDELINES FOR NOISE CERTIFICATION OF PROPELLER-DRIVEN STOL AEROPLANES

*Note.— See Part II, Chapter 7.*

*Note 1.— For the purpose of these guidelines, STOL aeroplanes are those which, when operating in the short take-off and landing mode, consistent with the relevant airworthiness requirements, require a runway length (with no stopway or clearway) of not more than 610 m at maximum certificated mass for airworthiness.*

*Note 2.— These guidelines are not applicable to aircraft with vertical take-off and landing capabilities.*

### 1. APPLICABILITY

The following guidelines should be applied to all propeller-driven aeroplanes of over 5 700 kg maximum certificated take-off mass intended for operation in the short take-off and landing (STOL) mode, requiring a runway<sup>1</sup> length, compatible with the relevant take-off and landing distance requirements, of less than 610 m at maximum certificated mass for airworthiness, and for which a certificate of airworthiness for the individual aeroplane was first issued on or after 1 January 1976.

### 2. NOISE EVALUATION MEASURE

The noise evaluation measure should be the effective perceived noise level in EPNdB as described in Appendix 2 to this Annex.

### 3. NOISE MEASUREMENT REFERENCE POINTS

The aeroplane, when tested in accordance with the flight test procedure of Section 6, should not exceed the noise levels specified in Section 4 at the following reference points:

- a) *lateral noise reference point*: the point on a line parallel to and 300 m from the runway centre line, or extended runway centre line, where the noise level is a maximum during take-off or landing, with the aeroplane operating in the STOL mode;
- b) *flyover noise reference point*: the point on the extended centre line of the runway 1 500 m from the start of the take-off roll; and
- c) *approach noise reference point*: the point on the extended centre line of the runway 900 m from the runway threshold.

---

1. With no stopway or clearway.

#### 4. MAXIMUM NOISE LEVELS

The maximum noise level at any of the reference points, when determined in accordance with the noise evaluation method of Appendix 2, should not exceed 96 EPNdB in the case of aeroplanes with maximum certificated mass of 17 000 kg or less, this limit increasing linearly with the logarithm of mass at a rate of 2 EPNdB per doubling of mass in the case of aeroplanes having maximum certificated mass in excess of 17 000 kg.

#### 5. TRADE-OFFS

If the maximum noise levels are exceeded at one or two measurement points:

- a) the sum of any excesses should not be greater than 4 EPNdB;
- b) any excess at any single point should not be greater than 3 EPNdB; and
- c) any excesses should be offset by a corresponding reduction at the other point or points.

#### 6. TEST PROCEDURES

6.1 The take-off reference procedure should be as follows:

- a) the aeroplane should be at the maximum take-off mass for which noise certification is requested;
- b) the propeller and/or engine speed (rpm) and engine power setting scheduled for STOL take-off should be used; and
- c) throughout the take-off noise certification demonstration test, the airspeed, climb gradient, aeroplane attitude and aeroplane configuration should be those specified in the flight manual for take-off in the STOL mode.

6.2 The approach reference procedure should be as follows:

- a) the aeroplane should be at the maximum landing mass for which the noise certification is requested;
- b) throughout the approach noise certification demonstration test, the propeller and/or engine speed (rpm), engine power setting, airspeed, descent gradient, aeroplane attitude and aeroplane configuration should be those specified in the flight manual for STOL landing; and
- c) the use of reverse thrust after landing should be the maximum specified in the flight manual.

#### 7. ADDITIONAL NOISE DATA

Where so specified by the certifying authority, data permitting measured noise levels to be evaluated in terms of the A-weighted overall sound pressure level (dB(A)) should be provided.

# **ATTACHMENT C. GUIDELINES FOR NOISE CERTIFICATION OF INSTALLED AUXILIARY POWER UNITS (APU) AND ASSOCIATED AIRCRAFT SYSTEMS DURING GROUND OPERATION**

*Note.— See Part II, Chapter 9.*

## **1. INTRODUCTION**

1.1 The following guidance material has been prepared for the information of States establishing noise certification requirements for installed auxiliary power units (APU) and associated aircraft systems used during normal ground operation.

1.2 It should apply to installed APU and associated aircraft systems in all aircraft for which the application for a Type Certificate, or another equivalent prescribed procedure, is submitted on or after 26 November 1981.

1.3 For aircraft of existing type design, for which the application for a change of type design involving the basic APU installation, or another equivalent prescribed procedure, is made on or after 26 November 1981, the noise levels produced by installed APU and associated aircraft systems should not exceed those existing prior to the change, when determined in accordance with the following guidelines.

## **2. NOISE EVALUATION PROCEDURE**

The noise evaluation procedure should be according to the methods specified in Section 4.

## **3. MAXIMUM NOISE LEVELS**

The maximum noise levels, when determined in accordance with the noise evaluation procedure specified in Section 4, should not exceed the following:

- a) 85 dB(A) at the points specified in 4.4.2.2 a), b) and c);
- b) 90 dB(A) at any point on the perimeter of the rectangle shown in Figure C-2.

## **4. NOISE EVALUATION PROCEDURES**

### **4.1 General**

4.1.1 Test procedures are described for measuring noise at specific locations (passenger and cargo doors, and servicing positions) and for conducting general noise surveys around aircraft.

4.1.2 Requirements are identified with respect to instrumentation, acoustic and atmospheric environment data acquisition, reduction and presentation, and such other information as is needed for reporting the results.

4.1.3 Procedures involve recording data on magnetic tape for subsequent processing. The use of tape-recorder time-integrating analyser systems avoids the need to average by eye the variations associated with manual readings from sound level meters and octave band analysers and therefore yields more accurate results.

4.1.4 No provision is made for predicting APU noise from basic engine characteristics, nor for measuring noise of more than one aircraft operating at the same time.

## 4.2 General test conditions

### 4.2.1 Meteorological conditions

*Wind:* not more than 5.1 m/s (10 kt).

*Note.*— *The noise certification test windows for wind speed expressed in m/s are the result of converting historically used values expressed in knots using a conversion factor consistent with Annex 5, Chapter 3, Table 3-3, and rounded to 0.1 m/s. The values as given here, expressed in either unit, are considered equivalent for establishing adherence to the wind speed test windows for noise certification purposes.*

*Temperature:* not less than 2°C nor more than 35°C.

*Humidity:* relative humidity not less than 30 per cent nor more than 90 per cent.

*Precipitation:* none.

*Barometric pressure:* not less than 800 hPa nor more than 1 100 hPa.

### 4.2.2 Test site

The ground between microphone and aircraft should be a smooth, hard surface. No obstructions should be present between aircraft and measurement positions and no reflecting surfaces (except the ground and aircraft) should be near enough to sound paths to significantly influence results. Surface of the ground surrounding the aircraft should be sensibly flat and level at least over an area formed by boundaries parallel to and 60 m beyond the outermost microphone array identified in 4.4.2.2 d).

### 4.2.3 Ambient noise

Ambient noise of the measurement system and test area (that is, composite of the noise due to environmental background and the electrical noise of the acoustic instrumentation) should be determined.

### 4.2.4 APU installation

Pertinent APU and associated aircraft systems should be tested for each aircraft model for which acoustic data are required.

### 4.2.5 Aircraft ground configuration

Aircraft flight control surfaces should be in the “neutral” or “clean” configuration, with gust locks on, or as stated in the aircraft’s approved operating manual for aircraft undergoing servicing.

### 4.3 Instrumentation

#### 4.3.1 Aircraft

Operational data identified in 4.5.4 should be determined from normal aircraft instruments and controls.

#### 4.3.2 Acoustical

##### 4.3.2.1 General

Instrumentation and measurement procedures should be consistent with requirements of latest applicable issues of appropriate Standards listed in the references (see 4.6). All data samples should be at least 2.5 times the data reduction integration period which in no case should be less than 8 s. All sound pressure levels should be in decibels to a reference pressure of 20  $\mu$ Pa.

##### 4.3.2.2 Data acquisition systems

Instrumentation systems for recording and analysis of noise, shown in the block diagram of Figure C-1, should meet the following specifications:

##### 4.3.2.2.1 Microphone system

- a) over a frequency range of at least 45 Hz to 11 200 Hz the system should meet the requirements as outlined under microphone system specifications in the latest issue of reference 10 (see 4.6);
- b) microphones should be omnidirectional, vented for pressure equalization if of condenser type, and should have known ambient pressure and temperature coefficients. Microphone amplifier specifications should be compatible with those of the microphone and tape recorder; and
- c) microphone windscreens should be employed when wind speed is in excess of 3 m/s (6 kt). Corrections as a function of frequency should be applied to measured data to account for the presence of microphone windscreens.

##### 4.3.2.2.2 Tape recorder

The tape recorder may be direct record or FM and should have the following characteristics:

- a) dynamic range of 50 dB minimum in the octave or one-third octave bands;
- b) tape speed accuracy within  $\pm 0.2$  per cent of rated speed;
- c) wow and flutter (peak to peak) less than 0.5 per cent of tape speed;
- d) maximum third harmonic distortion less than 2 per cent.

##### 4.3.2.3 Calibration

##### 4.3.2.3.1 Microphone

Frequency response calibration should be performed prior to the test series and a subsequent post-calibration should be performed within one month of the pre-calibration, with additional calibrations made when shock or damage is suspected.

Response calibration should cover the range of at least 45 Hz to 11 200 Hz. Pressure response characteristics of the microphone should be corrected to obtain random incidence calibration.

#### 4.3.2.3.2 Recording system

- a) A calibration tape, a recording of broadband noise or a sweep of sinusoidal signals over a minimum frequency range of 45 Hz to 11 200 Hz should be recorded in the field or in the laboratory at the beginning and end of each test. The tape should also include signals at the frequencies employed during sound pressure sensitivity checks as defined below.
- b) This calibration signal, an insert voltage, should be applied to the input and should include all signal conditioning preamplifiers, networks and recorder electronics used to record acoustic data. In addition, a “shorted input” (i.e. microphone pressure sensitive element replaced with equivalent electrical impedance) recording of at least 20 s should be made as a check on system dynamic range and noise floor.
- c) Sound pressure sensitivity calibrations with the arrangements shown in Figure C-1 should be made in the field for each microphone prior to beginning and after completion of measurements each day. These calibrations should be made using a calibrator producing a known and constant-amplitude sound pressure level at one or more one-third octave band centre frequencies, specified in reference 11 in the frequency range from 45 Hz to 11 200 Hz. A barometric correction should be applied as required. Calibrators employed should be precise at least to within  $\pm 0.5$  dB and should have a calibration obtained according to references 6 to 9 (see 4.6).
- d) Each reel of tape should have comparable response and background noise to the calibration tape. A constant amplitude sine wave should be recorded at the start of each reel of tape, for reel-to-reel sound pressure sensitivity comparisons. The frequency of this sine wave should be within the same frequency range as used for sound pressure sensitivity checks. A separate voltage insert device or an acoustic calibrator may be used for this purpose. If an acoustic calibrator is used, it should be carefully “seated” and corrections for ambient pressure should be made so that effects of pressure on calibrator and microphone response are eliminated.
- e) Battery-driven tape recorders should be checked at frequent intervals during a test to ensure good battery condition. Tape recorders should not be moved while recording is in progress unless it has been established that such movements will not change tape-recorder characteristics.

#### 4.3.2.3.3 Data reduction equipment

Data reduction equipment should be calibrated with electrical signals of known amplitude either at a series of discrete frequencies or with broadband signals covering the frequency range of 45 Hz to 11 200 Hz.

#### 4.3.2.4 Data reduction

4.3.2.4.1 The data reduction system of Figure C-1 should provide one-third or one octave band sound pressure levels. Analyser filters should comply with requirements of reference 12 (Class II for octave band filters and Class III for one-third octave band filters). Analyser amplitude resolution should be no worse than 0.5 dB; dynamic range should be a minimum of 50 dB between full scale and the root-mean-square (rms) value of the analyser noise floor in the octave band with the highest noise floor; and amplitude response over the upper 40 dB range should be linear to within  $\pm 0.5$  dB.

4.3.2.4.2 Mean-square sound pressures should be time averaged by integration of the squared output of frequency band filters over an integration interval that should be no less than 8 s. All data should be processed within the frequency range from 45 Hz to 11 200 Hz. Data should be corrected for all known or predictable errors, such as deviations of system frequency response from a flat response.

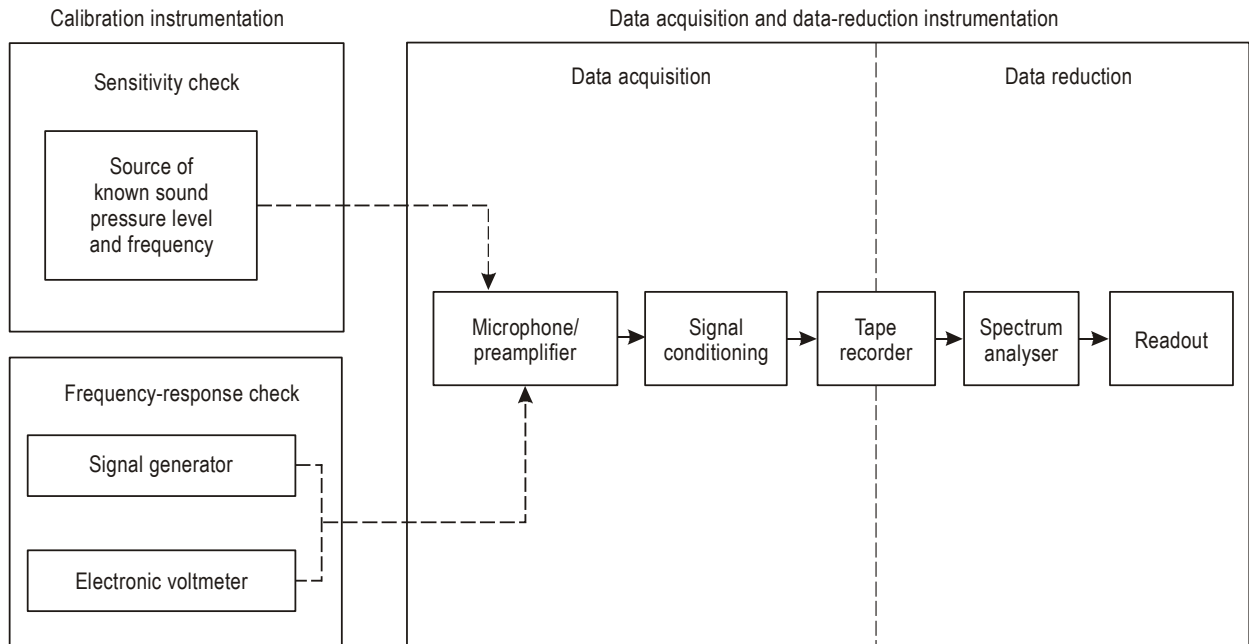

Figure C-1. Noise measurement systems

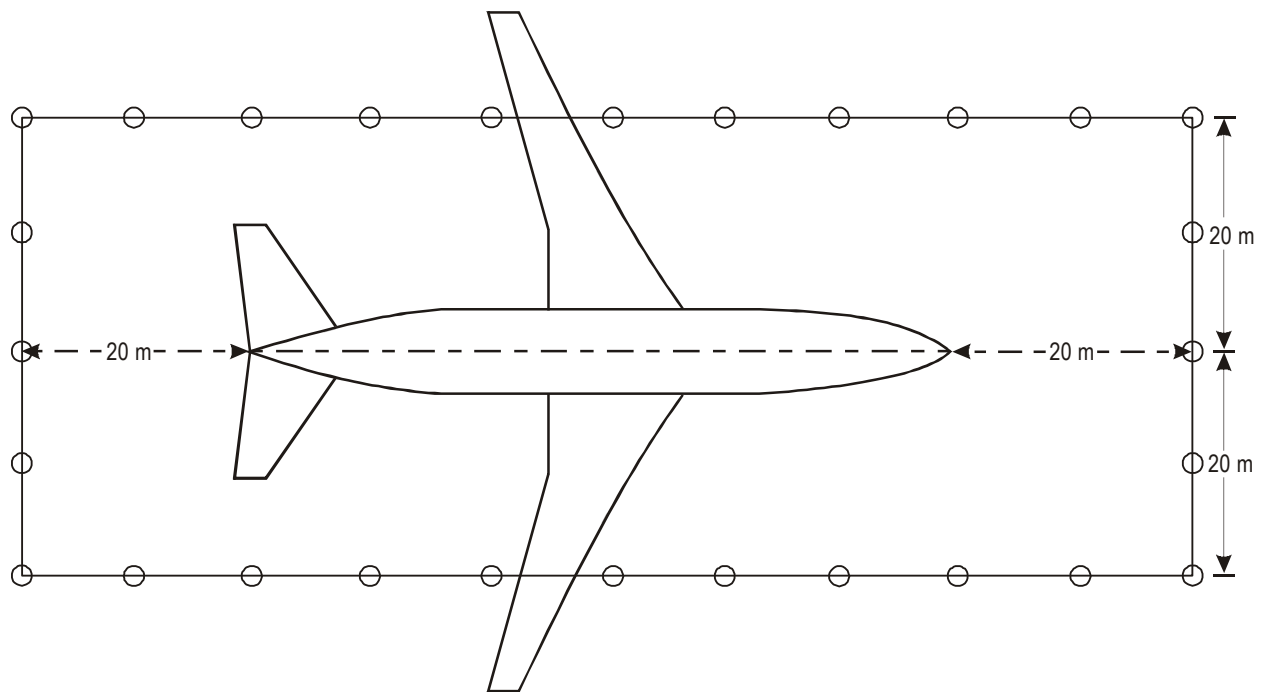

Figure C-2. Rectangle of noise survey measurement positions

#### 4.3.2.5 Total system

4.3.2.5.1 In addition to specifications for component systems, frequency response of the combined data acquisition and reduction system should be flat within  $\pm 3$  dB over the frequency range from 45 Hz to 11 200 Hz. Frequency response gradient anywhere within this range should not exceed 5 dB per octave.

4.3.2.5.2 Amplitude resolution should be at least 1.0 dB. Dynamic range should be a minimum of 45 dB between full scale and the rms value of the system noise floor in the frequency band with the highest noise floor. Amplitude response should be linear within  $\pm 0.5$  dB over the upper 35 dB in each frequency band.

#### 4.3.3 Meteorological

The wind speed should be measured with a device having a range of at least 0 to 7.5 m/s (0 to 15 kt) with an accuracy of at least  $\pm 0.5$  m/s ( $\pm 1$  kt). Temperature measurements should be made with a device having a range of at least 0°C to 40°C with an accuracy of at least  $\pm 0.5$ °C. Relative humidity should be measured with a device having a range of 0 to 100 per cent with an accuracy of at least  $\pm 5$  percentage points. Atmospheric pressure should be measured with a device having a range of at least 800 to 1 100 hPa with an accuracy of at least  $\pm 3$  hPa.

### 4.4 Test procedure

#### 4.4.1 Test conditions

4.4.1.1 Ambient noise measurements should be made in sufficient number to be representative for all acoustic measurement stations, providing correction data to apply to measured APU noise where necessary (see 4.4.4).

4.4.1.2 The installed APU should meet the noise levels specified in 3.1 at the points specified under typical loads, up to and including those imposed by the electric power generator and air-conditioning units and any other associated systems at their normal maximum continuous ground operation power requirements.

*Note.— A measurement of noise from a particular model of auxiliary power unit installed in a specific aircraft type should not be deemed typical of the same equipment installed in other aircraft types nor of other models of APU installed in the same aircraft type.*

#### 4.4.2 Acoustical measurement locations

4.4.2.1 Except where specified otherwise, noise measurements should be made with microphones at  $1.6 \text{ m} \pm 0.025 \text{ m}$  ( $5.25 \text{ ft} \pm 1.0 \text{ in}$ ) above the ground or surface where passengers or servicing personnel may stand, with the microphone diaphragm parallel to the ground and facing upwards.

4.4.2.2 Locations for measuring noise should be as follows:

- a) *cargo door locations*: measurements should be made at each cargo door location, with the door open, while the aircraft is in a typical ground handling configuration. These measurements should be taken at the centre of the opening, in the plane of the fuselage skin;
- b) *passenger door locations*: measurements should be made at each passenger entry door, with the door open, on the vertical centre line of the opening, in the plane of the fuselage skin;



- c) *servicing locations*: measurements should be made at all servicing positions where persons are normally working during aircraft ground handling operations, these positions to be determined by reference to the approved aircraft operating and service manuals;
- d) *survey locations*: appropriate measurement positions should be chosen along the sides of a rectangle centred on the test aircraft as illustrated in Figure C-2. The distance between measurement positions should not be greater than 10 m for large aircraft. This distance may be reduced to accommodate small aeroplanes or to fulfil special requirements.

#### 4.4.3 Meteorological measurement locations

Meteorological data should be measured at a location at the test site within the microphone array of Figure C-2, but upwind of the aircraft and at a height of 1.6 m (5.25 ft) above ground level.

#### 4.4.4 Data presentation

4.4.4.1 A-weighted sound levels should be calculated by applying frequency weighting corrections derived from the Standards for precision sound level meters (reference 10) to one-third or one octave band sound pressure levels. The one octave band sound pressure levels may be determined from a summation of mean-square sound pressures in appropriate one-third octave bands. Overall sound pressure levels should be determined from a summation of mean-square sound pressures in the 24 one-third octave, or 8 one octave, frequency bands included in the frequency range from 45 Hz to 11 200 Hz.

4.4.4.2 Overall sound pressure levels, A-weighted sound levels and one-third or one octave band data should be presented to the nearest decibel (dB) in tabular form, with supplementary graphical presentations as appropriate. Sound pressure levels should be corrected, if necessary, for the presence of high ambient noise. No corrections are needed if a sound pressure level is 10 dB or more above ambient noise. For sound pressure levels between 3 and 10 dB above ambient noise, measured values should be corrected for ambient noise by logarithmic subtraction of levels. If sound pressure levels do not exceed ambient noise by as much as 3 dB, the measured values may be adjusted by means of a method agreed to by the certificating authority.

4.4.4.3 Acoustical data need not be normalized for atmospheric absorption losses. Test results should be reported under the actual test-day meteorological conditions.

### 4.5 Data reporting

#### 4.5.1 Identification information

- a) Test location, date and time of test.
- b) Manufacturer and model of the APU and pertinent associated equipment.
- c) Aircraft type, manufacturer, model and air registry number.
- d) Plan and elevation views, as appropriate, of the aircraft outline showing location of the APU (including inlet and exhaust ports), all associated equipment, and all acoustical measurement stations.

#### 4.5.2 Test site description

- a) Type and location of ground surfaces.

- b) Location and extent of any above-ground-level reflective surfaces, such as buildings or other aircraft, that might have been present in spite of the precautions noted in 4.2.2.

#### 4.5.3 Meteorological data (*for each test condition*)

- a) Wind speed, m/s (kt) and direction, degrees, relative to aircraft centre line (forward 0°).
- b) Ambient temperature °C.
- c) Relative humidity, per cent.
- d) Barometric pressure, hPa.

#### 4.5.4 Operational data (*for each test condition*)

- a) Number of air-conditioning packs operated and their locations.
- b) APU shaft speed(s), rpm or percentage of normal rated.
- c) APU normal rated shaft speed, rpm.
- d) APU shaft load (kW), horsepower and/or electric power output, kVA.
- e) Pneumatic load, kg/min delivered by APU to all pneumatically operated aircraft systems during the test (calculated as required).
- f) Temperature of APU exhaust gas at location specified in aircraft's approved operations manual, °C.
- g) Operating mode of environmental control system, cooling or heating.
- h) Air-conditioning distribution system supply duct temperature, °C.
- i) Events occurring during the test which may have influenced the measurements.

#### 4.5.5 Instrumentation

- a) A brief description (including manufacturer and type or model numbers) of the acoustical and meteorological measuring instruments.
- b) A brief description (including manufacturer and type or model numbers) of the data acquisition and data processing systems.

#### 4.5.6 Acoustical data

- a) Ambient noise.
- b) Acoustical data specified in 4.4.4 with a description of corresponding microphone locations.
- c) List of standards used and description and reason for any deviations.

#### 4.6 References

Related standard for instruments and measurement procedures

1. *International Electrotechnical Vocabulary*, 2nd Edition, IEC-50(08) (1960).
2. *Acoustic Standard Tuning Frequency*, ISO-16.
3. *Expression of the Physical and Subjective Magnitudes of Sound or Noise*, ISO-131 (1959).
4. *Acoustics — Preferred Reference Quantities for Acoustic Levels*, ISO DIS 1638.2.
5. *Guide to the Measurement of Acoustical Noise and Evaluation of its Effects on Man*, ISO-2204 (1973).
6. *Precision Method for Pressure Calibration of One-inch Standard Condenser Microphone by the Reciprocity Technique*, IEC-327 (1971).
7. *Precision Method for Free Field Calibration of One-inch Standard Condenser Microphone by the Reciprocity Technique*, IEC-486 (1974).
8. *Values for the Difference between Free Field and Pressure Sensitivity Levels for One-inch Standard Condenser Microphone*, IEC-655 (1979).
9. *Simplified Method for Pressure Calibration of One-inch Standard Condenser Microphone by the Reciprocity Technique*, IEC-402 (1972).
10. *IEC Recommendations for Sound Level Meters*, International Electrotechnical Commission, IEC 651 (1979).
11. *ISO Recommendations for Preferred Frequencies for Acoustical Measurements*, International Organization for Standardization, ISO/R266-1962(E).
12. *IEC Recommendations for Octave, Half-Octave and Third-Octave Band Filters Intended for the Analysis of Sounds and Vibrations*, International Electrotechnical Commission, IEC 225 (1966).

*Note.*— *The texts and specifications of these publications, as amended, are incorporated by reference into this attachment.*

IEC publications may be obtained from:

Central Office of the International Electrotechnical Commission  
3 rue de Varembe  
Geneva, Switzerland

ISO publications may be obtained from:

International Organization for Standardization  
1 rue de Varembe  
Geneva, Switzerland

or from State ISO member bodies.



# **ATTACHMENT D. GUIDELINES FOR EVALUATING AN ALTERNATIVE METHOD OF MEASURING HELICOPTER NOISE DURING APPROACH**

*Note.— The approach reference procedure of Part II, Chapter 8, 8.6.4, specifies a single approach path angle. This can coincide with the impulsive noise regime for some helicopters and not for others. In order that alternative methods of establishing compliance may be evaluated, States are encouraged to undertake additional measurements as described below.*

## **1. INTRODUCTION**

The following guidance material has been prepared for the use of States when obtaining additional information on which a future revision of the approach test procedures of Chapter 8 may be based.

## **2. APPROACH NOISE EVALUATION PROCEDURE**

When conducting such tests the provisions of Chapter 8 shall be observed except as follows.

### **2.1 Approach reference noise measurement points**

A flight path reference point located on the ground 120 m (394 ft) vertically below the flight paths defined in the approach reference procedure. On level ground this corresponds to the following positions:

- a) 2 290 m from the intersection of the 3° approach path with the ground plane;
- b) 1 140 m from the intersection of the 6° approach path with the ground plane;
- c) 760 m from the intersection of the 9° approach path with the ground plane.

### **2.2 Maximum noise levels**

At the approach flight path reference point: the noise level to be calculated by taking the arithmetical average of the corrected levels for 3°, 6° and 9° approaches.

### **2.3 Approach reference procedure**

The approach reference procedure shall be established as follows:

- a) the helicopter shall be stabilized and following approach paths of 3°, 6° and 9°;

- b) the approach shall be made at a stabilized airspeed equal to the best rate of climb speed,  $V_Y$ , or the lowest approved speed for the approach, whichever is the greater, with power stabilized during the approach and over the flight path reference point, and continued to a normal touchdown;
- c) the approach shall be made with the rotor speed stabilized at the maximum normal operating rpm certificated for approach;
- d) the constant approach configuration used in airworthiness certification tests, with the landing gear extended, shall be maintained throughout the approach reference procedure; and
- e) the mass of the helicopter at touchdown shall be the maximum landing mass at which noise certification is requested.

---

# ATTACHMENT E. APPLICABILITY OF ANNEX 16 NOISE CERTIFICATION STANDARDS FOR PROPELLER-DRIVEN AEROPLANES<sup>1</sup>

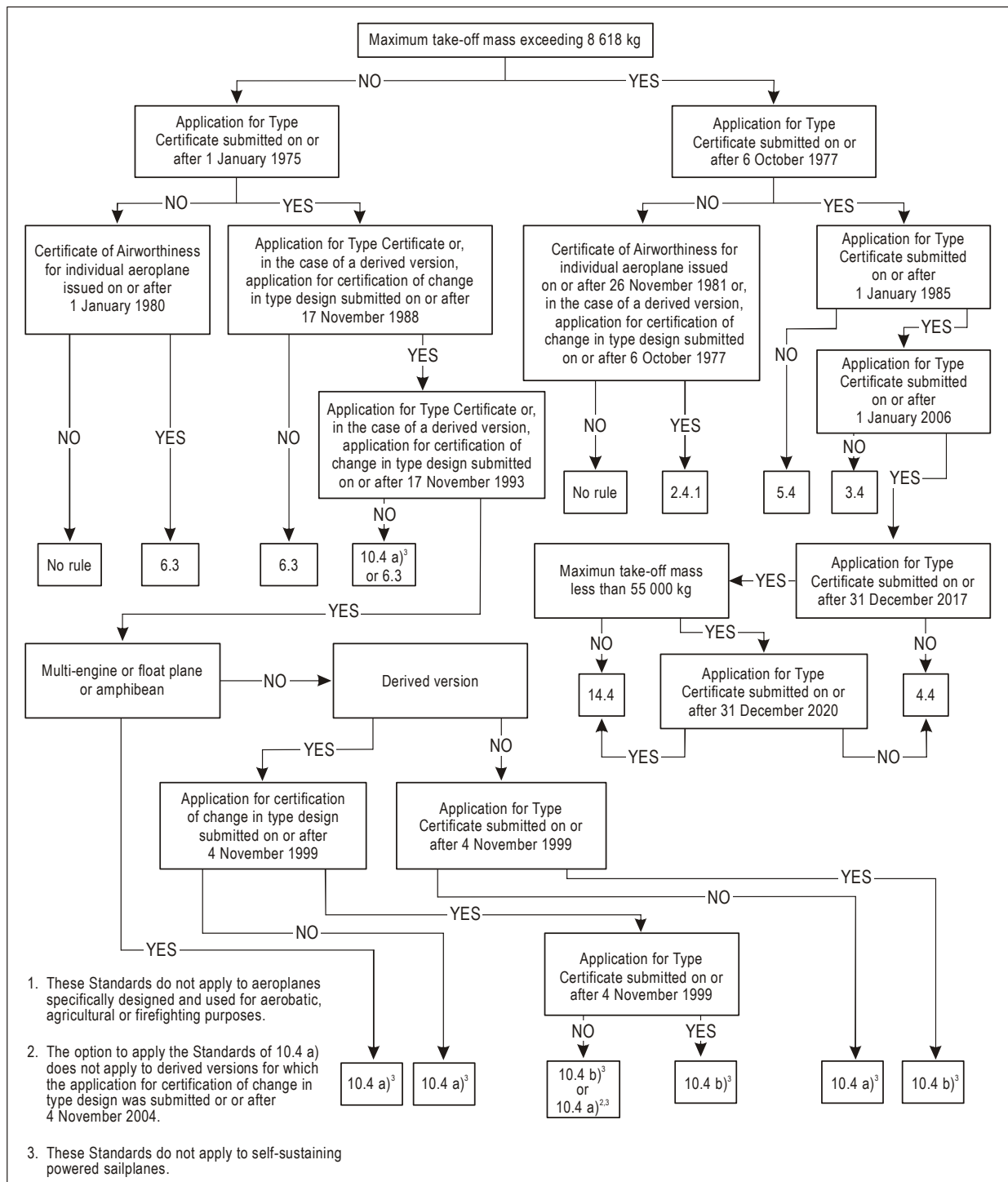





# ATTACHMENT F. GUIDELINES FOR NOISE CERTIFICATION OF TILT-ROTORS

*Note.— See Part II, Chapter 13.*

*Note.— These guidelines are not intended to be used for tilt-rotors that have one or more configurations that are certificated for airworthiness for STOL only. In such cases, different or additional guidelines would likely be needed.*

## 1. APPLICABILITY

The following guidelines should be applied to all tilt-rotors, including their derived versions, for which the application for a Type Certificate was submitted on or after 13 May 1998 and before 1 January 2018.

*Note.— Certification of tilt-rotors which are capable of carrying external loads or external equipment should be made without such loads or equipment fitted.*

## 2. NOISE EVALUATION MEASURE

The noise evaluation measure should be the effective perceived noise level in EPNdB as described in Appendix 2 of this Annex.

*Note.— Additional data in  $L_{AE}$  and  $L_{ASmax}$  as defined in Appendix 4, and one-third octave SPLs as defined in Appendix 2 corresponding to  $L_{ASmax}$  should be made available to the certifying authority for land-use planning purposes.*

## 3. NOISE MEASUREMENT REFERENCE POINTS

A tilt-rotor, when tested in accordance with the reference procedures of Section 6 and the test procedures of Section 7, should not exceed the noise levels specified in Section 4 at the following reference points:

a) *Take-off reference noise measurement points:*

- 1) a flight path reference point located on the ground vertically below the flight path defined in the take-off reference procedure (see 6.2) and 500 m horizontally in the direction of flight from the point at which transition to climbing flight is initiated in the reference procedure;
- 2) two other points on the ground symmetrically disposed at 150 m on both sides of the flight path defined in the take-off reference procedure and lying on a line through the flight path reference point.

- b) *Overflight reference noise measurement points:*
- 1) a flight path reference point located on the ground 150 m (492 ft) vertically below the flight path defined in the overflight reference procedure (see 6.3);
  - 2) two other points on the ground symmetrically disposed at 150 m on both sides of the flight path defined in the overflight reference procedure and lying on a line through the flight path reference point.
- c) *Approach reference noise measurement points:*
- 1) a flight path reference point located on the ground 120 m (394 ft) vertically below the flight path defined in the approach reference procedure (see 6.4). On level ground, this corresponds to a position 1 140 m from the intersection of the 6.0° approach path with the ground plane;
  - 2) two other points on the ground symmetrically disposed at 150 m on both sides of the flight path defined in the approach reference procedure and lying on a line through the flight path reference point.

#### 4. MAXIMUM NOISE LEVELS

For tilt-rotors specified in Section 1, the maximum noise levels, when determined in accordance with the noise evaluation method of Appendix 2 for helicopters, should not exceed the following:

- a) *For take-off:* 109 EPNdB for tilt-rotors in VTOL/conversion mode with maximum certificated take-off mass, at which the noise certification is requested, of 80 000 kg and over and decreasing linearly with the logarithm of the tilt-rotor mass at a rate of 3 EPNdB per halving of mass down to 89 EPNdB after which the limit is constant.
- b) *For overflight:* 108 EPNdB for tilt-rotors in VTOL/conversion mode with maximum certificated take-off mass, at which the noise certification is requested, of 80 000 kg and over and decreasing linearly with the logarithm of the tilt-rotor mass at a rate of 3 EPNdB per halving of mass down to 88 EPNdB after which the limit is constant.

*Note 1.— For the tilt-rotor in aeroplane mode, there is no maximum noise level.*

*Note 2.— VTOL/conversion mode is all approved configurations and flight modes where the design operating rotor speed is that used for hover operations.*

- c) *Fort approach:* 110 EPNdB for tilt-rotors in VTOL/conversion mode with maximum certificated take-off mass, at which the noise certification is requested, of 80 000 kg and over and decreasing linearly with the logarithm of the tilt-rotor mass at a rate of 3 EPNdB per halving of mass down to 90 EPNdB after which the limit is constant.

*Note.— The equations for the calculation of noise levels as a function of take-off mass presented in Section 7 of Attachment A, for conditions described in Chapter 8, 8.4.1, are consistent with the maximum noise levels defined in these guidelines.*

#### 5. TRADE-OFFS

If the maximum noise levels are exceeded at one or two measurement points:

- a) the sum of excesses should not be greater than 4 EPNdB;

- b) any excess at any single point should not be greater than 3 EPNdB; and
- c) any excess should be offset by corresponding reductions at the other point or points.

## 6. NOISE CERTIFICATION REFERENCE PROCEDURES

### 6.1 General conditions

6.1.1 The reference procedures should comply with the appropriate airworthiness requirements.

6.1.2 The reference procedures and flight paths should be approved by the certifying authority.

6.1.3 Except in conditions specified in 6.1.4, the take-off, overflight and approach reference procedures should be those defined in 6.2, 6.3 and 6.4, respectively.

6.1.4 When it is shown by the applicant that the design characteristics of the tilt-rotor would prevent a flight from being conducted in accordance with 6.2, 6.3 or 6.4, the reference procedures should:

- a) depart from the reference procedures defined in 6.2, 6.3 or 6.4 only to the extent demanded by those design characteristics which make compliance with the reference procedures impossible; and
- b) be approved by the certifying authority.

6.1.5 The reference procedures should be calculated under the following reference atmospheric conditions:

- a) constant atmospheric pressure of 1 013.25 hPa;
- b) constant ambient air temperature of 25°C;
- c) constant relative humidity of 70 per cent; and
- d) zero wind.

6.1.6 In 6.2 d), 6.3 d) and 6.4 c), the maximum normal operating rpm should be taken as the highest rotor speed for each reference procedure corresponding to the airworthiness limit imposed by the manufacturer and approved by the certifying authority. Where a tolerance on the highest rotor speed is specified, the maximum normal operating rotor speed should be taken as the highest rotor speed about which that tolerance is given. If the rotor speed is automatically linked with the flight condition, the maximum normal operating rotor speed corresponding with the reference flight condition should be used during the noise certification procedure. If the rotor speed can be changed by pilot action, the maximum normal operating rotor speed specified in the flight manual limitation section for the reference conditions should be used during the noise certification procedure.

### 6.2 Take-off reference procedure

The take-off reference flight procedure should be established as follows:

- a) a constant take-off configuration, including nacelle angle, selected by the applicant should be maintained throughout the take-off reference procedure;

- b) the tilt-rotor should be stabilized at the maximum take-off power corresponding to minimum installed engine(s) specification power available for the reference ambient conditions or gearbox torque limit, whichever is lower, and along a path starting from a point located 500 m prior to the flight path reference point, at 20 m (65 ft) above the ground;
- c) the nacelle angle and the corresponding best rate of climb speed, or the lowest approved speed for the climb after take-off, whichever is the greater, should be maintained throughout the take-off reference procedure;
- d) the steady climb should be made with the rotor speed stabilized at the maximum normal operating rpm certificated for take-off;
- e) the mass of the tilt-rotor should be the maximum take-off mass at which noise certification is requested; and
- f) the reference take-off path is defined as a straight line segment inclined from the starting point (500 m prior to the centre noise measurement point and 20 m (65 ft) above ground level) at an angle defined by best rate of climb (BRC) and the best rate of climb speed corresponding to the selected nacelle angle and for minimum specification engine performance.

### 6.3 Overflight reference procedure

6.3.1 The overflight reference procedure should be established as follows:

- a) the tilt-rotor should be stabilized in level flight overhead the flight path reference point at a height of 150 m (492 ft);
- b) a constant configuration selected by the applicant should be maintained throughout the overflight reference procedures;
- c) the mass of the tilt-rotor should be the maximum take-off mass at which noise certification is requested;
- d) in the VTOL/conversion mode, the nacelle angle at the authorized fixed operation point that is closest to the lowest nacelle angle certificated for zero airspeed, a speed of  $0.9 V_{CON}$  and a rotor speed stabilized at the maximum normal operating rpm certificated for level flight should be maintained throughout the overflight reference procedure;

*Note.— For noise certification purposes,  $V_{CON}$  is defined as the maximum authorized speed for VTOL/conversion mode at a specific nacelle angle.*

- e) in the aeroplane mode, the nacelles should be maintained on the down-stop throughout the overflight reference procedure, with:
  - 1) rotor speed stabilized at the rpm associated with the VTOL/conversion mode and a speed of  $0.9 V_{CON}$ ; and
  - 2) rotor speed stabilized at the normal cruise rpm associated with the aeroplane mode and at the corresponding  $0.9 V_{MCP}$  or  $0.9 V_{MO}$ , whichever is lesser, certificated for level flight.

*Note.— For noise certification purposes,  $V_{MCP}$  is defined as the maximum operating limit airspeed for aeroplane mode corresponding to minimum engine installed, maximum continuous power (MCP) available for sea level pressure (1 013.25 hPa), 25°C ambient conditions at the relevant maximum certificated mass; and  $V_{MO}$  is the maximum operating (MO) limit airspeed that may not be deliberately exceeded.*

6.3.2 The values of  $V_{CON}$  and  $V_{MCP}$  or  $V_{MO}$  used for noise certification should be quoted in the approved flight manual.

#### 6.4 Approach reference procedure

The approach reference procedure should be established as follows:

- a) the tilt-rotor should be stabilized and follow a  $6.0^\circ$  approach path;
- b) the approach should be in an airworthiness-approved configuration in which maximum noise occurs, at a stabilized airspeed equal to the best rate of climb speed corresponding to the nacelle angle, or the lowest approved airspeed for the approach, whichever is the greater, and with power stabilized during the approach and over the flight path reference point, and continued to a normal touchdown;
- c) the approach should be made with the rotor speed stabilized at the maximum normal operating rpm certificated for approach;
- d) the constant approach configuration used in airworthiness certification tests, with the landing gear extended, should be maintained throughout the approach reference procedure; and
- e) the mass of the tilt-rotor at touchdown should be the maximum landing mass at which noise certification is requested.

#### 7. TEST PROCEDURES

7.1 The test procedures should be acceptable to the airworthiness and noise certificating authority of the State issuing the certificate.

7.2 The test procedures and noise measurements should be conducted and processed in an approved manner to yield the noise evaluation measure designated in Section 2.

7.3 Test conditions and procedures should be similar to reference conditions and procedures or the acoustic data should be adjusted, by the methods outlined in Appendix 2 for helicopters, to the reference conditions and procedures specified in this attachment.

7.4 Adjustments for differences between test and reference flight procedures should not exceed:

- a) *for take-off*: 4.0 EPNdB, of which the arithmetic sum of  $\Delta_1$  and the term  $-7.5 \log (QK/Q_r K_r)$  from  $\Delta_2$  should not in total exceed 2.0 EPNdB; and
- b) *for overflight or approach*: 2.0 EPNdB.

7.5 During the test the average rotor rpm should not vary from the normal maximum operating rpm by more than  $\pm 1.0$  per cent throughout the 10 dB-down time period.

7.6 The tilt-rotor airspeed should not vary from the reference airspeed appropriate to the flight demonstration by more than  $\pm 9$  km/h ( $\pm 5$  kt) throughout the 10 dB-down time period.

7.7 The number of level overflights made with a headwind component should be equal to the number of level overflights made with a tailwind component.

7.8 The tilt-rotor should fly within  $\pm 10^\circ$  or  $\pm 20$  m ( $\pm 65$  ft), whichever is greater, from the vertical above the reference track throughout the 10 dB-down time period (see Figure 8-1 of Part II, Chapter 8).

7.9 The tilt-rotor height should not vary during overflight from the reference height throughout the 10 dB-down period by more than  $\pm 9$  m (30 ft).

7.10 During the approach noise demonstration the tilt-rotor should be established on a stabilized constant speed approach within the airspace contained between approach angles of  $5.5^\circ$  and  $6.5^\circ$  throughout the 10 dB-down period.

7.11 Tests should be conducted at a tilt-rotor mass not less than 90 per cent of the relevant maximum certificated mass and may be conducted at a mass not exceeding 105 per cent of the relevant maximum certificated mass. For each of the flight conditions, at least one test must be completed at or above this maximum certificated mass.

---

# ATTACHMENT G. GUIDELINES FOR THE ADMINISTRATION OF NOISE CERTIFICATION DOCUMENTATION

*Note.— See Part II, Chapter 1.*

## 1. INTRODUCTION

The following information is provided for the benefit of States that wish to have further guidance on the administration of noise certification documentation. These guidelines are not intended to be applied retroactively, but if States wish to apply the proposed formats retroactively they are free to do so.

## 2. NOISE CERTIFICATION DOCUMENTATION

### 2.1 Information to be provided

2.1.1 Chapter 1, 1.5, specifies which information shall, as a minimum, be included in the noise certification documentation. The following provides further guidance on these items. Note that all items must be numbered in accordance with 1.5 and 1.6 of Part II, Chapter 1, using Arabic numbers. This is to facilitate access to the information when the noise certification documentation is issued in a language foreign to the user of the information. Some items are relevant to certain chapters only. In these cases the relevant chapters are indicated in the item.

#### 2.1.2 *Item 1. Name of State*

The name of the State issuing the noise certification documentation. This item should correspond with the information on the certificate of registration and the certificate of airworthiness.

#### 2.1.3 *Item 2. Title of the noise document*

As explained in Section 2.3, several different kinds of documents can be issued depending on the administrative system for implementation of the noise certification documentation. The system chosen will determine the name of the document or documents, for instance “noise certificate”, “noise certification document” or any other title that the State of Registry uses in its administrative system.

#### 2.1.4 *Item 3. Number of the document*

A unique number, issued by the State of Registry, that identifies this particular document in its administration. Such a number will facilitate any enquiries with respect to the document.

#### 2.1.5 *Item 4. Nationality or common mark and registration marks*

The nationality or common mark and registration marks issued by the State of Registry in accordance with Annex 7. This item should correspond with the information on the certificate of registration and the certificate of airworthiness.

### 2.1.6 *Item 5. Manufacturer and manufacturer's designation of aircraft*

The type and model of the subject aircraft. This item should correspond with the information on the certificate of registration and the certificate of airworthiness.

### 2.1.7 *Item 6. Aircraft serial number*

The aircraft serial number as given by the manufacturer of the aircraft. This item should correspond with the information on the certificate of registration and the certificate of airworthiness.

### 2.1.8 *Item 7. Engine manufacturer, type and model*

The designation of the installed engine(s) for identification and verification of the aircraft configuration. It should contain the type and model of the subject engine(s). The designation should be in accordance with the type certificate or supplemental type certificate for the subject engine(s).

### 2.1.9 *Item 8. Propeller type and model for propeller-driven aeroplanes*

The designation of the installed propeller(s) for identification and verification of the aircraft configuration. It should contain the type and model of the subject propeller(s). The designation should be in accordance with the type certificate or supplemental type certificate for the subject propeller(s). This item is included only in the noise certification documentation for propeller-driven aeroplanes.

### 2.1.10 *Item 9. Maximum take-off mass and unit*

The maximum take-off mass, in kilograms, associated with the certificated noise levels of the aircraft. The unit (kg) should be specified explicitly in order to avoid misunderstanding. If the primary unit of mass of the State of Design of the aircraft is different from kilograms, the conversion factor used should be in accordance with Annex 5.

### 2.1.11 *Item 10. Maximum landing mass, in kilograms, for certificates issued under Chapters 2, 3, 4, 5, 12 and 14*

The maximum landing mass, in kilograms, associated with the certificated noise levels of the aircraft. The unit (kg) should be specified explicitly in order to avoid misunderstanding. If the primary unit of mass of the State of Design of the aircraft is different from kilograms, the conversion factor used should be in accordance with Annex 5. This item is included only in the noise certification documentation for documents issued under Chapters 2, 3, 4, 5, 12 and 14.

### 2.1.12 *Item 11. The chapter and section of Annex 16, Volume I, according to which the aircraft is certificated*

The chapter of Annex 16, Volume I, to which the subject aircraft is noise certificated. For Chapters 2, 8, 10 and 11, the section specifying the noise limits should also be included.

### 2.1.13 *Item 12. Additional modifications incorporated for the purpose of compliance with the applicable noise certification Standards*

This item should contain, as a minimum, all additional modifications to the basic aircraft as defined by Items 5, 7 and 8 that are essential in order to meet the requirements of the chapter of Annex 16, Volume I, to which the aircraft is noise certificated



as given under Item 11. Other modifications that are not essential to meet the stated chapter but are needed to attain the certificated noise levels as given may also be included at the discretion of the certificating authority. The additional modifications should be given using unambiguous references, such as supplemental type certificate (STC) numbers, unique part numbers or type/model designators given by the manufacturer of the modification.

2.1.14 *Item 13. The lateral/full-power noise level in the corresponding unit for documents issued under Chapters 2, 3, 4, 5, 12 and 14*

The lateral/full-power noise level as defined in the relevant chapter. It should specify the unit (e.g. EPNdB) of the noise level, and the noise level should be stated to the nearest tenth of a dB. This item is included only in the noise certification documentation for aircraft certificated to Chapters 2, 3, 4, 5, 12 and 14.

2.1.15 *Item 14. The approach noise level in the corresponding unit for documents issued under Chapters 2, 3, 4, 5, 8, 12, 13 and 14*

The approach noise level as defined in the relevant chapter. It should specify the unit (e.g. EPNdB) of the noise level, and the noise level should be stated to the nearest tenth of a dB. This item is included only in the noise certification documentation for aircraft certificated to Chapters 2, 3, 4, 5, 8, 12, 13 and 14.

2.1.16 *Item 15. The flyover noise level in the corresponding unit for documents issued under Chapters 2, 3, 4, 5, 12 and 14*

The flyover noise level as defined in the relevant chapter. It should specify the unit (e.g. EPNdB) of the noise level, and the noise level should be stated to the nearest tenth of a dB. This item is included only in the noise certification documentation for aircraft certificated to Chapters 2, 3, 4, 5, 12 and 14.

2.1.17 *Item 16. The overflight noise level in the corresponding unit for documents issued under Chapters 6, 8, 11 and 13*

The overflight noise level as defined in the relevant chapter. It should specify the unit (e.g. EPNdB or dB(A)) of the noise level, and the noise level should be stated to the nearest tenth of a dB. This item is included only in the noise certification documentation for aircraft certificated to Chapters 6, 8, 11 and 13.

*Note.— For tilt-rotors certificated according to Chapter 13 only the overflight noise level established in VTOL/conversion mode needs to be stated.*

2.1.18 *Item 17. The take-off noise level in the corresponding unit for documents issued under Chapters 8, 10 and 13*

The take-off noise level as defined in the relevant chapter. It should specify the unit (e.g. EPNdB or dB(A)) of the noise level, and the noise level should be stated to the nearest tenth of a dB. This item is included only in the noise certification documentation for aircraft certificated to Chapters 8, 10 and 13.

2.1.19 *Item 18. Statement of compliance, including reference to Annex 16, Volume I*

A statement that the subject aircraft complies with the applicable noise requirements. Reference should be made to Annex 16, Volume I. In addition to this, reference may be made to national noise requirements.

### 2.1.20 *Item 19. Date of issuance of the noise certification document*

The date on which the noise certification document was issued.

### 2.1.21 *Item 20. Signature of the officer issuing it*

The signature of the officer issuing the noise certification document. Other items may be added such as a seal or a stamp.

## 2.2 Additional information

2.2.1 States may decide to add additional information to the noise certification documentation at their own discretion. Caution should be exercised to ensure that the information provided will not be confused with the official noise certification levels. In particular, noise levels taken under conditions other than the noise certification conditions should be clearly marked as supplementary information. The additional information should be placed in a “remarks” box or in separate boxes. These boxes should *not* be numbered in order to avoid non-standardized numbering and to allow for future modifications to the numbering system. The box or boxes should contain an adequate description of what additional information is provided. Examples of possible additional information are provided in 2.2.2 through 2.2.7.

### 2.2.2 *Logo and name of the issuing authority*

In order to facilitate recognition, the logo or symbol and the name of the issuing authority may be added.

### 2.2.3 *Noise limits*

If added, noise limits should be given according to the subject noise requirements and should be quoted, to the nearest tenth of a decibel, in the appropriate unit. If national noise requirements use different limits (more or less stringent), this should be clearly marked, and in order to avoid confusion the ICAO limits should also be quoted.

### 2.2.4 *Language*

States issuing their noise certification documentation in a language other than English should provide an English translation in accordance with Annex 6.

### 2.2.5 *References to national requirements*

Reference to national requirements can be combined with Item 18 or can be added as a separate item.

### 2.2.6 *Other aircraft modifications*

Other modifications from the basic aircraft model as specified under Item 5 and Items 7 through 10 to aid further identification of the noise configuration can be provided at the discretion of the State of Registry. Note that any modifications required to meet the Standards to which any document is issued should be reported under Item 12.

### 2.2.7 *Date of expiry*

If the State of Registry limits the validity of the noise certification documentation, it should include the date of expiry.

### 2.3 Formats for noise certification documentation

2.3.1 In view of the wide variety of administrative needs for systems for noise certification documentation, three alternative standardized options are provided:

- 1) A stand-alone noise certificate in which the mandatory information requirements of Annex 16, Volume I, are contained in a single document.
- 2) Two complementary documents of which one may be the aeroplane flight manual (AFM) or the aircraft operating manual (AOM).
- 3) Three complementary documents.

#### 2.3.2 Option 1. One document

The first option is an administrative system in which the document attesting noise certification takes the form of a separate noise certificate that contains all the items identified in Part II, Chapter 1, 1.5. A standard format is provided in Figure G-1. States using this format may deviate from this where needed to meet their national requirements and/or to include any additional items. It should however be generally similar to Figure G-1. Note that not all items will be mentioned on every noise certificate. For instance, not all Items 13 through 17 will be mentioned on one noise certificate since they are not all applicable to every chapter. Normally, only one certificate per aircraft serial number should be issued and be valid at the same time. If a noise certificate has lost its validity, it should be suspended or revoked to avoid the situation that more than one noise certificate is current for an aircraft. If multiple documents for this option have been issued, it should be easy to determine which document is applicable at any given time.

#### 2.3.3 Option 2. Two complementary documents

2.3.3.1 The second option is an administrative system consisting of two documents in which the first official document attests noise certification, but is limited to identification of the aircraft, and the statement of compliance, containing only Items 1 through 6 and Items 18 through 20 of 2.1. This can be either in the form of a (limited) noise certificate or in the form of a certificate of airworthiness for those States that include noise requirements in their airworthiness requirements. In the latter case, there is no need for Item 18 (statement of compliance with reference to Annex 16) since compliance is implicit. The numbering of the items in the certificate of airworthiness will be according to the convention in Annex 8. In these cases the remaining items of 2.1 should be transferred to a complementary standardized noise certification document, normally as a page of the AFM or AOM certified by the State of Registry, the format of which can be very similar to that of the noise certificate described under 2.3.2. Therefore the format given in Figure G-1 can equally serve as a standard format for the complementary document, although some items may not be needed.

2.3.3.2 Normally only one set of the two documents should be issued for each aircraft. If a noise certification document has lost its validity, it should be suspended or revoked. If multiple documents have been issued under this option, it should be obvious from the documentation which document is applicable at any given time.

#### 2.3.4 Option 3. Three complementary documents

2.3.4.1 The third option is an administrative system consisting of three documents in which the first official document is identical to the first document of Option 2, 2.3.3.1. It attests noise certification and is therefore also limited to identification of the aircraft, and the statement of compliance, containing only Items 1 through 6 and Items 18 through 20 of 2.1. This can be either in the form of a noise certificate or in the form of a certificate of airworthiness for those States that include noise requirements in their airworthiness requirements (with the same observation as in the second option). The remaining items of 2.1 should be transferred to the second and third complementary noise certification documents.

2.3.4.2 The second document, normally presented as a page (or set of following pages) in the AFM or AOM, certified by the State of Registry, list(s) all the configurations operated or forecast to be operated by the aircraft fleet from the date of issuance of the page(s). The fleet is composed of all aircraft that are operated with the same flight manual. The format of the information can be very similar to that of the noise certificate described under 2.3.2, all information corresponding to a given configuration comprising Item 5 and Items 7 through 17. Each list of parameters corresponding to a given configuration is identified by a “configuration number”, for example “x”. Therefore the format given in Figure G-1 can equally serve for the items concerned, with the addition of the configuration number.

For use by State of Registry		1. <State of Registry>		3. Document number:	
<b>2. NOISE CERTIFICATE</b>					
4. Nationality and registration marks:		5. Manufacturer and manufacturer’s designation of aircraft:		6. Aircraft serial number:	
7. Engine:			8. Propeller:*		
9. Maximum take-off mass:  kg		10. Maximum landing mass:*\br/> kg		11. Noise certification Standard:	
12. Additional modifications incorporated for the purpose of compliance with the applicable noise certification Standards:					
13. Lateral/full-power noise level:*	14. Approach noise level:*	15. Flyover noise level:*	16. Overflight noise level:*	17. Take-off noise level:*	
Remarks:					
18. This noise certificate is issued pursuant to Volume I of Annex 16 to the Convention on International Civil Aviation, in respect of the above-mentioned aircraft, which is considered to comply with the indicated noise Standard when maintained and operated in accordance with the relevant requirements and operating limitations.					
19. Date of issue.....			20. Signature.....		

\* These boxes may be omitted depending on the noise certification Standard.

**Figure G-1. Noise certificate**

2.3.4.3 The third document under this option is issued according to a national regulatory process. It states that an aircraft with a given serial number has operated in the configuration number “x” since the date of issuance of this third document. If multiple documents for this option have been issued, it should be obvious from the documentation which document is applicable at any given time.

---



# **ATTACHMENT H. GUIDELINES FOR OBTAINING HELICOPTER NOISE DATA FOR LAND-USE PLANNING PURPOSES**

## **1. INTRODUCTION**

The following guidance material has been prepared for the use of States wishing to utilize noise certification data, or optional supplementary test data, for land-use planning purposes. The purpose of this guidance material is to assist in the provision of data suitable for the prediction of helicopter noise exposure contours and to support the development of heliport noise abatement operational procedures.

## **2. DATA COLLECTION PROCEDURES**

2.1 Data suitable for land-use planning purposes may be derived directly from Chapter 8 noise certification data. Chapter 8 applicants may optionally elect to acquire data suitable for land-use planning purposes via alternative take-off, approach and/or flyover procedures defined by the applicant and approved by the certificating authority. Alternative flyover procedures should be performed overhead the flight path reference point at a height of 150 m (492 ft). In addition, an applicant may optionally elect to provide data at additional microphone locations.

2.2 Chapter 11 noise certification data may be provided for land-use planning purposes. Chapter 11 applicants may optionally elect to provide data acquired via alternative flyover procedures at 150 m (492 ft) above ground level. In acquiring data for land-use planning purposes, Chapter 11 applicants should give consideration to acquiring data from two additional microphones symmetrically disposed at 150 m (492 ft) on each side of the flight path and/or additional take-off and approach procedures defined by the applicant and approved by the certificating authority. In addition, an applicant may optionally elect to provide data at additional microphone locations.

2.3 All data provided for land-use planning purposes should be corrected to the appropriate reference conditions via the approved procedures of Chapter 8 and Chapter 11 or, for alternative flight procedures, by appropriate correction procedures approved by the certificating authority.

## **3. REPORTING OF DATA**

3.1 All data provided for land-use planning purposes should be submitted to the certificating authority for approval. The approved data and the corresponding flight procedures should be presented as supplementary information in the helicopter flight manual.

3.2 It is recommended that all data provided for land-use planning purposes be presented in terms of average sound exposure level,  $L_{AE}$ , as defined in Appendix 4 of this volume, for left sideline, centre line and right sideline measurement points defined relative to the direction of flight for each test run. Additional data in other noise metrics may also be provided and should be derived in a manner that is consistent with the prescribed noise certification analysis procedure.

— END —







ISBN 978-92-9258-260-9



9

789292

582609