



**POSITRONIC**<sup>®</sup>  
GLOBAL *Connector* SOLUTIONS

+

# Miniature Circle Hex Connectors



Featuring High Performance,  
Lightweight, Composite Construction

+

Catalog C-013 Rev. D

[www.connectpositronic.com](http://www.connectpositronic.com)

# Connector Excellence®

## Positronic Provides Complete Capability

### Mission Statement

*"To utilize product flexibility and application assistance to present quality interconnect solutions which represent value to customers worldwide."*

### Experience

- Founded in **1966**
- **Involvement** in the development of international connector specifications through EIA®, IEC and ISO as well as PICMG® and VITA.
- Introduction of new and **unique connector products** to the electronics industry.
- Patent holder for many **unique connector features and manufacturing techniques**.
- **Vertically integrated** manufacturing – raw materials to finished connectors.

### Technology

- **Expertise** with solid machined contacts provides a variety of high reliability connectors including high current density power connectors.
- Quality Assurance lab is **capable of testing** to IEC, EIA, UL, C.UL, military and customer-specified requirements.
- **In-house design and development** of connectors based on market need or individual customer requirements.
- **Internal manufacturing capabilities** include automatic precision contact machining, injection molding, stamping, plating operations and connector assembly.
- **Manufacturing locations** in southwest Missouri, U.S.A. (headquarters); Puerto Rico, France, China, Singapore, and India. Total square footage: 369,000.

### Support

- **Quality Systems:** Select locations qualified to ISO9001:2000, ISO14001, AS9100, MIL-STD-790 and customer "dock to stock" programs. Applicable products qualified to MIL-DTL-24308, SAE AS39029, DSCC 85039, MIL-DTL-28748, Space D32, GSFC S-311-P-4 and GSFC S-311-P-10.
- Compliance to a variety of international and customer specific **environmental requirements**.
- Large **in-house inventory** of finished connectors. Customer specific **stocking programs**.
- Factory direct **technical sales support** in major cities worldwide.
- **One-on-one customer support** from worldwide factory locations.
- World class **web site**.
- **Value-added solutions** and willingness to **develop custom products** with reasonable price and delivery.



### Regional Headquarters

Springfield, MO



Auch, France



Singapore



Products described within this catalog may be protected by one or more of the following US patents:

- #4,900,261    #5,255,580    #5,329,697
- #6,260,268    #6,835,079    #7,115,002

Patented in Canada, 1992    Other Patents Pending

Positronic Industries' **FEDERAL SUPPLY CODE** (Cage Code)  
FOR MANUFACTURERS is **28198**

Unless otherwise specified, **dimensional tolerances** are:

- 1) ±0.001 inches [0.03 mm] for male contact mating diameters.
- 2) ±0.003 inches [0.08 mm] for contact termination diameters.
- 3) ±0.005 inches [0.13 mm] for all other diameters.
- 4) ±0.015 inches [0.38 mm] for all other dimensions.

**POSITRONIC® IS AN ITAR REGISTERED COMPANY**

Information in this catalog is proprietary to Positronic and its subsidiaries. Positronic believes the data contained herein to be reliable. Since the technical information is given free of charge, the user employs such information at his own discretion and risk. Positronic Industries assumes no responsibility for results obtained or damages incurred from use of such information in whole or in part.

Positronic®, Positronic Industries, Inc.®, P+ logo, Positronic Global Connector Solutions®, Connector Excellence® and their logo designs are registered trademarks of Positronic Industries, Inc.



## G H S E R I E S

General Product Information .....	1
Technical Characteristics .....	1
Exploded View of Typical Connector Assembly .....	2
Solder Cup Termination .....	3
Straight Solder Printed Board Mount Termination .....	3
Contact Hole Position Dimensions and Printed Board Mount Contact Hole Patterns .....	3
Connector Insulator Dimensions .....	4
Typical Mating Assemblies .....	4
Locking Devices .....	5
Aluminum Hoods .....	5
Plastic Hoods .....	6
Panel Mounting Information .....	7
Ordering Information .....	8

## L G H S E R I E S

General Product Information .....	9
Technical Characteristics .....	9
Solder Cup Termination .....	10
Straight Solder Printed Board Mount Termination .....	10
Contact Hole Position Dimensions and Printed Board Mount Contact Hole Patterns .....	10
Panel Mounting Information .....	10
Connector Insulator Dimensions .....	11
Ordering Information .....	11

## M G H S E R I E S

General Product Information .....	12
Technical Characteristics .....	12
Typical Assemblies .....	13
Panel Mounting Information .....	13
Ordering Information .....	14

Visit our website for the latest catalog updates and supplements at  
<http://www.connectpositronic.com/products/51/CircleHex/catalogs/>

# POSITRONIC CABLIZED CONNECTORS

## SAVE TIME AND MONEY!

Let Positronic support you by cablizing your  
**GH / LGH / MGH** connector selection.

### Cable Assembly Design Support

**We work closely with customers to:**

1. Design assemblies in accordance with customer specifications.
2. Prepare cablized connector configuration and performance specifications.
3. Design each system in accordance with applicable customer, domestic, and international standards.
4. Define and conduct performance and verification testing.



**Technical Sales Support**



**Engineering Support**

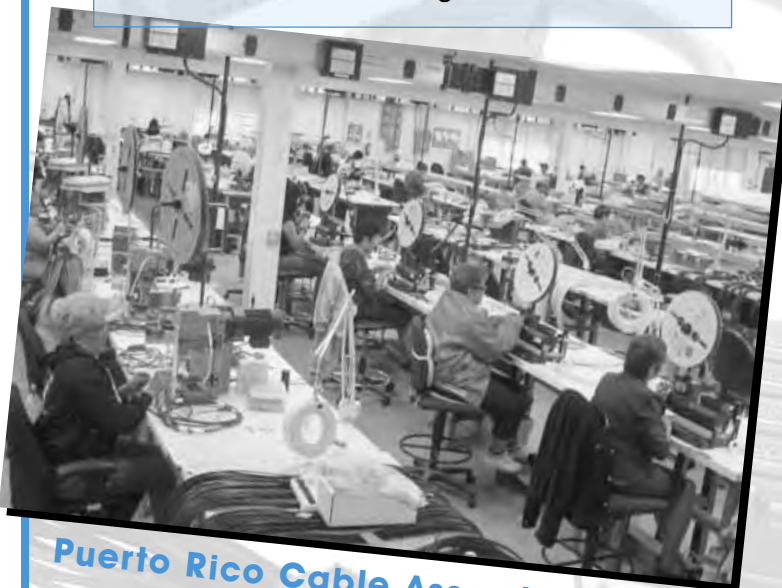

**Puerto Rico Cable Assembly**



**Quality Assurance**

FOR MORE DETAILS CONTACT **TECHNICAL SALES**  
OR VISIT OUR **WEB SITE** AT:

**[HTTP://WWW.CONNECTPOSITRONIC.COM/  
PRODUCTS/47/CABLEASSEMBLIES](http://www.connectpositronic.com/products/47/cableassemblies)**



**Size 20 Contacts**  
**High Performance Construction**  
**5 Insulator Variants**  
**4 through 10 Contacts**

UL Recognized  
File #E49351



GH series connectors are high reliability, hexagonal connectors offered with solder and straight solder terminations. Contacts have 0.040 inch [1.02 mm] diameters and are rated to 7.5 amperes per contact. Five connector variants, four through ten poles, are offered.

GH series connectors have DAP insulators. A variety of plastic and metal hoods are available, and the locking system is achieved by a lock-ring spring mechanism. Polarization is accomplished by contact layouts or by an oversized contact.

GH series connectors are ideal for use in industrial and instrumentation applications where light weight, miniature, high reliability interconnections are necessary.



**For RoHS options see page 8.**

## TECHNICAL CHARACTERISTICS

### MATERIALS AND FINISHES:

<b>Insulator:</b>	Glass-filled DAP per ASTM-D-5948, Type SDG-F. Grey color is standard.
<b>Contacts:</b>	Precision machined copper alloy.
<b>Contact Plating:</b>	Gold flash over nickel.
<b>Hoods:</b>	Aluminum with yellow or black anodize. Glass-filled DAP.
<b>Lock Rings and Lock Springs:</b>	Copper alloy with zinc plate and chromate seal.

### MECHANICAL CHARACTERISTICS:

<b>Fixed Contacts:</b>	Size 20 contact, male - 0.040 inch [1.02 mm] diameter. Female contact - open entry is standard. "Closed entry" is available on solder cup contacts for high reliability applications.
<b>Contact Retention in Insulator:</b>	10 lbs. [44.5N], minimum.
<b>Contact Termination:</b>	Solder cup - 0.046 inch [1.17 mm] hole diameter for 20 AWG [0.5 mm <sup>2</sup> ] wire maximum  Straight printed board mount - 0.025 inch [0.64 mm] termination diameter.
<b>Locking Systems:</b>	Friction, lock spring with lock ring.

### MECHANICAL CHARACTERISTICS, continued:

<b>Polarization:</b>	0.056 inch [1.42 mm] diameter male contact in position "A" on Size 4 connector. Molding configuration provides polarization on other sizes.
<b>Mechanical Operations:</b>	
<b>Open Entry Contacts:</b>	250 operations per IEC 60512-5.
<b>Closed Entry Contacts:</b>	500 operations per IEC 60512-5.

### ELECTRICAL CHARACTERISTICS:

<b>Contact Current Rating:</b>	7.5 amperes, maximum.
<b>Initial Contact Resistance:</b>	0.010 ohms, maximum.
<b>Flash over Voltage:</b>	1,750 VAC (rms).
<b>Test Voltage:</b>	1,200 VAC (rms).
<b>Insulation Resistance:</b>	5 G ohms.
<b>Clearance and Creepage Distance:</b>	0.025 inch [0.64 mm], minimum.
<b>Working Voltage:</b>	600 VAC (rms).

### CLIMATIC CHARACTERISTICS:

<b>Temperature Range:</b>	-55°C to +125°C.
<b>Damp Heat, Steady State:</b>	21 days.



Positronic Industries  
connectpositronic.com

# GH SERIES

## PROFESSIONAL QUALITY / FIXED CONTACTS

### MINIATURE CIRCLE HEX CONNECTORS

Circle  
Hex

GH SERIES

### EXPLODED VIEW OF TYPICAL CONNECTOR ASSEMBLY

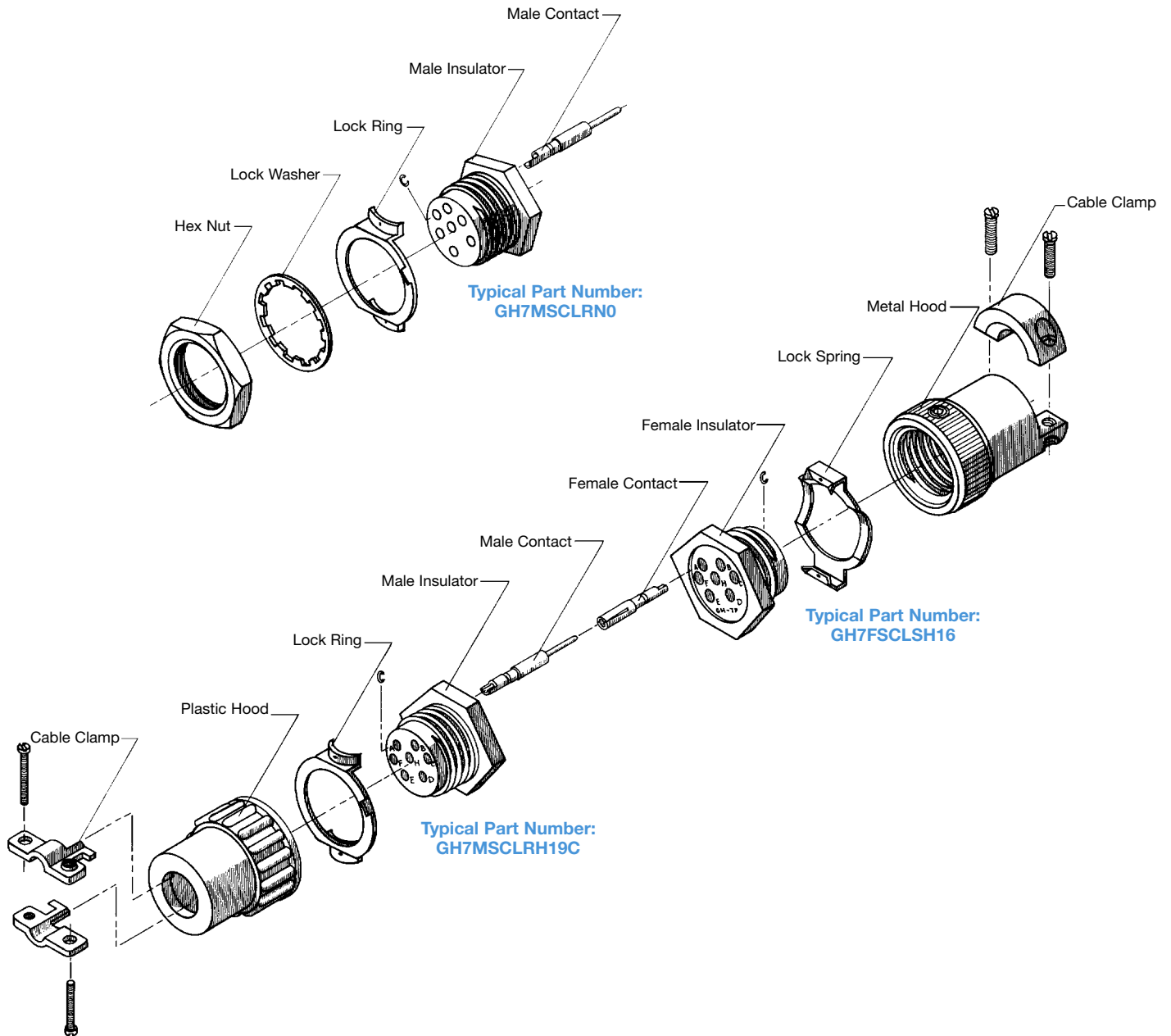



### SOLDER CUP TERMINATION

#### CODE SC \*1

For solder cup contacts, specify contact code "SC" in Step 4 of the ordering information on page 8.

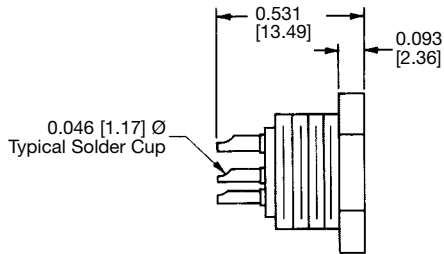

**TYPICAL PART NUMBER: GH4FSC00**

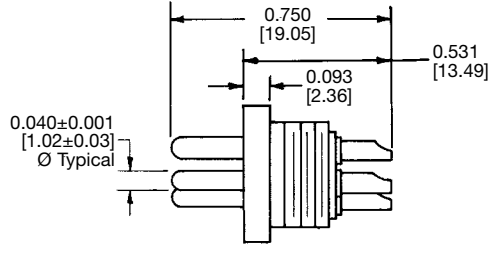

**TYPICAL PART NUMBER: GH4MSC00**

**NOTE:**

\*1 GH4 has 0.056±0.001 [1.42±0.03] Ø Pin in "A" position for polarization.

### STRAIGHT SOLDER PRINTED BOARD MOUNT TERMINATION

#### CODE DS3, DS4, DS5 and DS6 \*1

For straight solder contacts, specify contact code (DS3, DS4, DS5, or DS6) for desired length of contact termination in Step 4 of the ordering information on page 8.

**NOTE:**

\*1 Straight solder contacts are not available in GH4 connector.

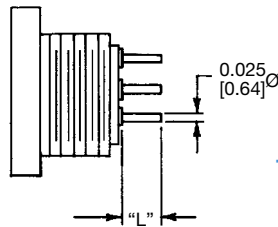

**TYPICAL PART NUMBER  
GH5FDS400**

CONTACT CODE	"L"
<b>DS3</b>	0.093 [2.36]
<b>DS4</b>	0.125 [3.18]
<b>DS5</b>	0.156 [3.96]
<b>DS6</b>	0.187 [4.75]

### CONTACT HOLE POSITION DIMENSIONS AND PRINTED BOARD MOUNT CONTACT HOLE PATTERN

HOLE IDENTIFICATION SHOWN IS FOR MATING FACE OF FEMALE CONNECTOR. USE MIRROR IMAGE FOR MALE CONNECTOR.

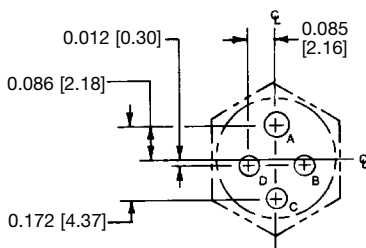

**GH4**

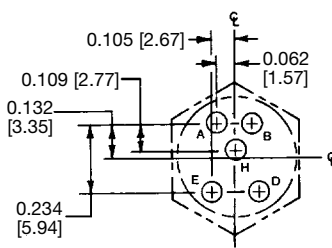

**GH5**

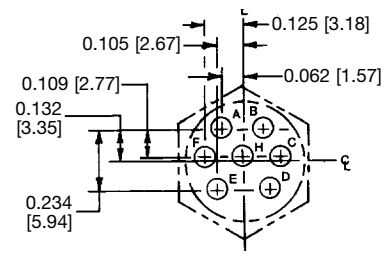

**GH7**

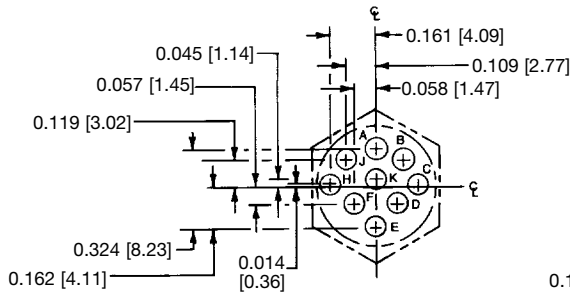

**GH9**

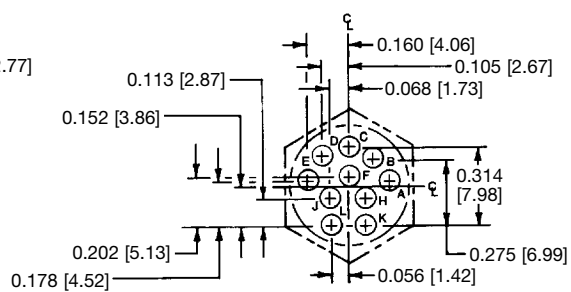

**GH10**

**SUGGESTED PRINTED BOARD HOLE SIZES:**

Suggest 0.040 [1.01] Ø holes in printed board for contact terminations.

**DIMENSIONS ARE IN INCHES [MILLIMETERS].  
ALL DIMENSIONS ARE SUBJECT TO CHANGE.**



Positronic Industries  
connectpositronic.com

# GH SERIES

## PROFESSIONAL QUALITY / FIXED CONTACTS

### MINIATURE CIRCLE HEX CONNECTORS

Circle  
Hex

GH SERIES

### INSULATOR DIMENSIONS

MATING FACE OF FEMALE CONNECTOR FOR SIZES GH 5, 7, 9, AND 10.

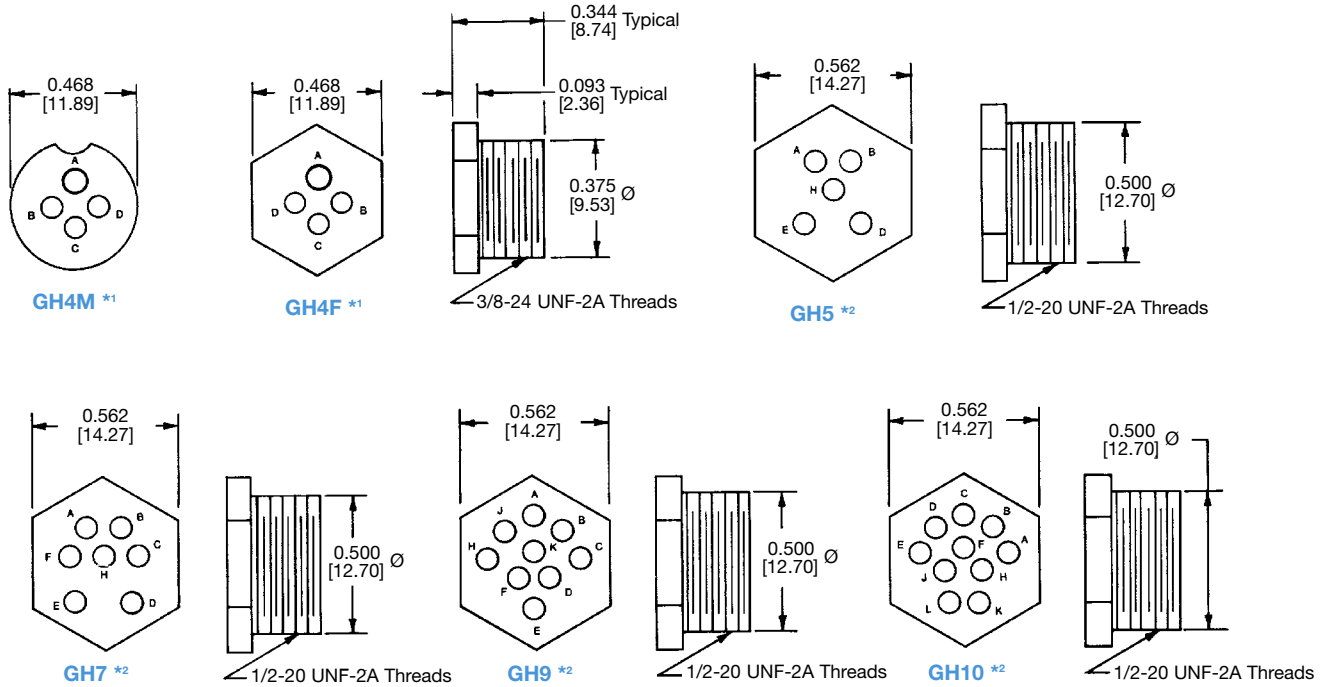

#### NOTES:

\*1 Size GH4 uses 0.056 [1.42]  $\varnothing$  pin in position "A" for polarization. For all other sizes, the body design provides polarization.

\*2 For Sizes 5 through 10, male and female connector dimensions are typical.

See GH Series Printed Board Hole Patterns, page 3 of this catalog, for contact variant hole positions.

### TYPICAL MATING ASSEMBLIES

GH4MSCLSH10C



GH4FSCLRNO

GH5FSCLRHH19S



GH5MSCLSH19

GH10FSCLSH16



GH10MDS4LRNO





**LOCKING DEVICES**

**LOCK SPRING  
CODE LS**

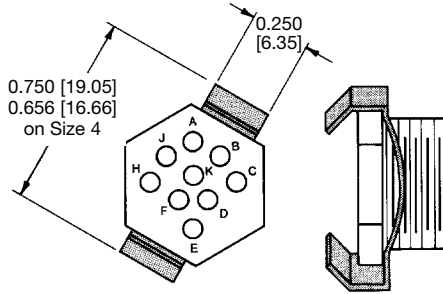

**LOCK RING AND NUT  
CODE LRN**

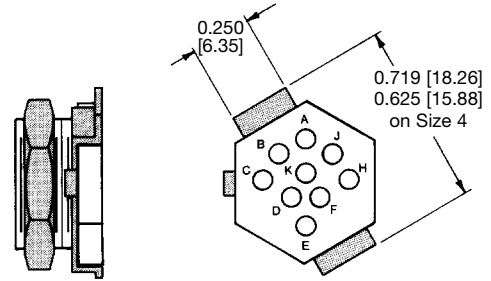

**ALUMINUM HOODS  
CODE H14 and H16**

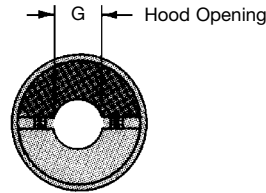
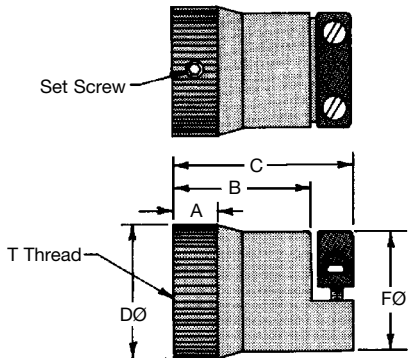

HOOD CODE	CONNECTOR SIZE	A	B	C	D	F	G	T THREAD
H14	GH-4	0.250 [6.35]	0.799 [20.29]	1.062 [26.97]	0.594 [15.09]	0.563 [14.30]	0.218 [5.54]	3/8-24 UNF-2B
H16	GH-5, 7, 9, 10	0.260 [6.60]	0.708 [17.98]	0.938 [23.82]	0.632 [16.05]	0.578 [14.68]	0.250 [6.35]	1/2-20 UNF-2B



Positronic Industries  
connectpositronic.com

# GH SERIES

## PROFESSIONAL QUALITY / FIXED CONTACTS

### MINIATURE CIRCLE HEX CONNECTORS

Circle  
Hex

GH SERIES

### STANDARD PLASTIC HOOD CODE H10 and H19

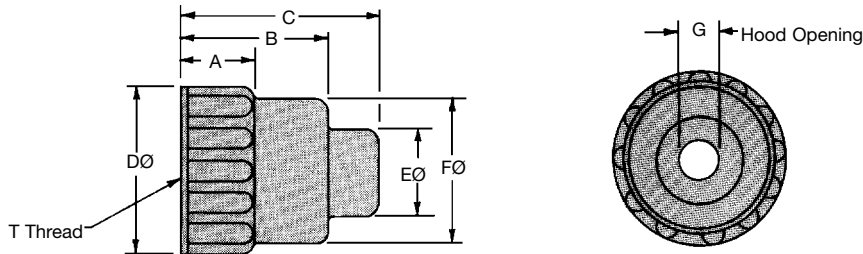

HOOD CODE	CONNECTOR SIZE	A	B	C	D	E	F	G	T THREAD
H10	GH4	0.312 [7.92]	0.687 [17.45]	0.750 [19.05]	0.562 [14.27]	0.250 [6.35]	0.437 [11.10]	0.157 [3.99]	3/8-24 UNF-2B
H19	GH 5, 7, 9, 10	0.281 [7.14]	0.656 [16.66]	0.875 [22.23]	0.655 [16.64]	0.422 [10.72]	0.540 [13.72]	0.297 [7.54]	1/2-20 UNF-2B

### SHORT PLASTIC HOOD CODE H10S and H19S

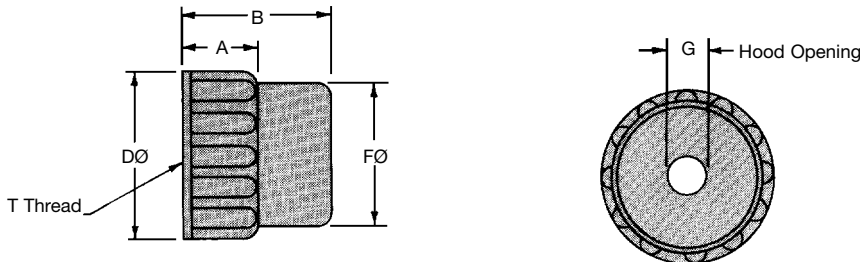

HOOD CODE	CONNECTOR SIZE	A	B	D	F	G	T THREAD
H10S	GH4	0.312 [7.92]	0.687 [17.45]	0.562 [14.27]	0.437 [11.10]	0.157 [3.99]	3/8-24 UNF-2B
H19S	GH 5, 7, 9, 10	0.281 [7.14]	0.656 [16.66]	0.655 [16.64]	0.540 [13.72]	0.297 [7.54]	1/2-20 UNF-2B

### PLASTIC HOODS WITH CABLE CLAMPS CODE H10C and H19C

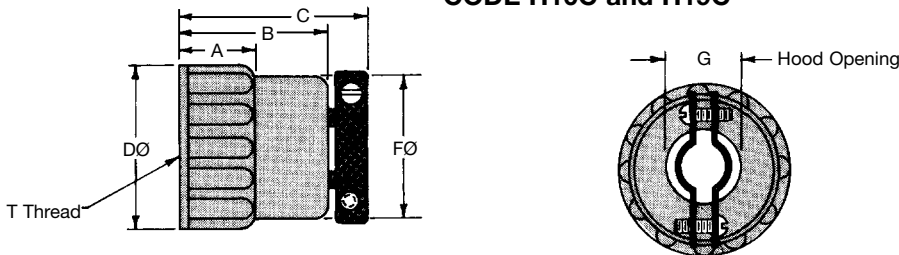

HOOD CODE	CONNECTOR SIZE	A	B	C	D	F	G	T THREAD
H10C	GH4	0.312 [7.92]	0.687 [17.45]	0.851 [21.61]	0.562 [14.27]	0.437 [11.10]	0.209 [5.31]	3/8-24 UNF-2B
H19C	GH 5, 7, 9, 10	0.281 [7.14]	0.656 [16.66]	0.820 [20.83]	0.655 [16.64]	0.540 [13.72]	0.297 [7.54]	1/2-20 UNF-2B



**PANEL CUT-OUT DIMENSIONS**

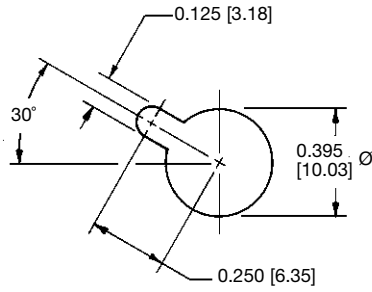

**SIZE 4**

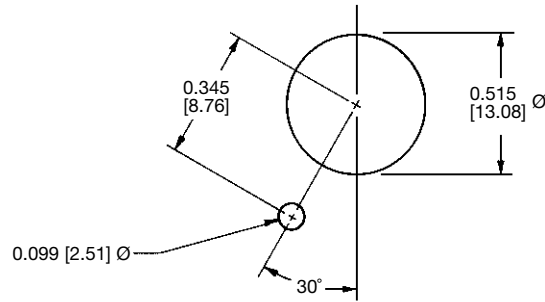

**SIZES 5, 7, 9, & 10**





Positronic Industries  
connectpositronic.com

# GH SERIES

## PROFESSIONAL QUALITY / FIXED CONTACTS

### MINIATURE CIRCLE HEX CONNECTORS

Circle  
Hex

## ORDERING INFORMATION - CODE NUMBERING SYSTEM

Specify Complete Connector By Selecting An Option From Step 1 Through 6

STEP	1	2	3	4	5	6	7	8	9
EXAMPLE	GH	10	M	SC	LRN	0	CE	/AA	

### STEP 1 - BASIC SERIES

GH Series

### STEP 2 - CONNECTOR VARIANTS

4, 5, 7, 9, 10

### STEP 3 - CONNECTOR GENDER

M - Male  
F - Female

### STEP 4 - CONTACT TERMINATION TYPE

SC - Solder Cup. For "Closed Entry" design, add "CE" in Step 7.  
DS3 - Straight Solder, 0.093 [2.36].  
DS4 - Straight Solder, 0.125 [3.18].  
DS5 - Straight Solder, 0.156 [3.96].  
DS6 - Straight Solder, 0.187 [4.75].  
NOTE: DS contacts are not available on GH4 connector.

### STEP 5 - MOUNTING AND LOCKING ACCESSORIES

LR - Lock Ring.  
LS - Lock Spring.  
N - Mounting Nut.  
W - Lockwasher.  
0 - If no mounting or locking accessories are required.  
NOTE: When the Lock Ring (LR) or Lock Spring (LS) are ordered with the Mounting Nut (N), a Lockwasher (W) is furnished.

**NOTE:** Once you have made a connector selection, contact Technical Sales if you would like to receive a drawing in DXF, PDF format or a 3-D IGES, STEP, or SOLIDWORKS file.

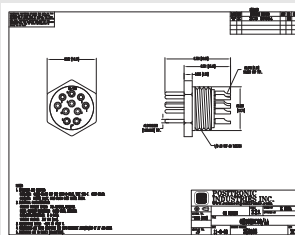

2-D Drawing

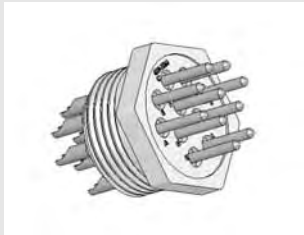

3-D Model

### STEP 9 - SPECIAL OPTIONS

**CONTACT TECHNICAL SALES FOR SPECIAL OPTIONS**

### STEP 8 - ENVIRONMENTAL COMPLIANCE OPTIONS

/AA - Compliant per EU Directive 2002/95/EC (RoHS)

**NOTE:** If compliance to environmental legislation is not required, this step will not be used.  
Example: GH10MSCLRNO



### STEP 7 - ADDITIONAL FEATURES

\*1 B - For black anodized aluminum parts.  
CE - "Closed Entry" contacts on female solder contact.

**NOTE:** Position "A" of GH4 connector is available as "Open Entry" only.

**SKIP STEP 7 - IF NO ADDITIONAL FEATURES ARE REQUIRED**

### STEP 6 - CABLE ADAPTERS (HOODS)

H10 - Standard plastic hood offered on 4 variant.  
H19 - Standard plastic hood offered on 5, 7, 9, and 10 variants.  
H10S - Short plastic hood offered on 4 variant.  
H19S - Short plastic hood offered on 5, 7, 9, and 10 variants.  
H10C - Plastic hood with cable clamps offered on 4 variant.  
H19C - Plastic hood with cable clamps offered on 5, 7, 9, and 10 variants.  
\*1 H14 - Aluminum hood offered on 4 variant.  
\*1 H16 - Aluminum hood offered on 5, 7, 9, and 10 variants.  
0 - If no hoods are required.

### NOTE:

\*1 Yellow anodize finish is standard for Aluminum parts.



**Size 20 Contacts**  
**High Performance Construction**  
**12 Contacts**

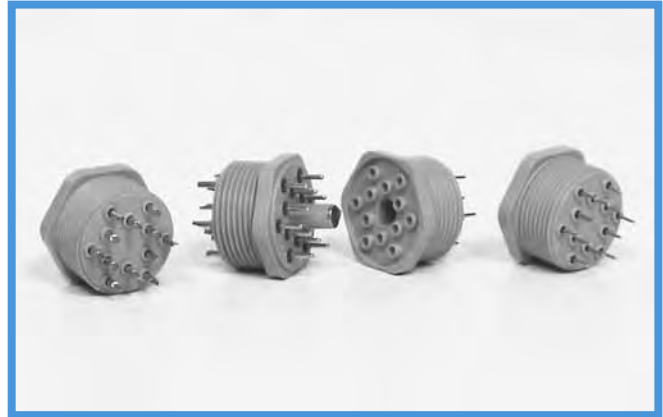

LGH series connectors are high reliability hexagonal connectors offered with wire solder and straight printed board mount contact terminations. Contacts have 0.040 inch [1.02mm] diameters and are rated at 7.5 amperes each.

LGH series connectors are ideal for use in industrial and instrumentation applications.

LGH series connectors have 12 contacts in a high performance connector package that includes a center post which serves to align and polarize the connectors during mating.



**For RoHS options see page 11.**

## TECHNICAL CHARACTERISTICS

### MATERIALS AND FINISHES:

<b>Insulator:</b>	Glass-filled polyester per MIL-M-24519, UL 94V-0. Grey color.
<b>Contacts:</b>	Precision machined copper alloy.
<b>Contact Plating:</b>	Gold flash over nickel.

### MECHANICAL CHARACTERISTICS:

<b>Fixed Contacts:</b>	Size 20 contact, male - 0.040 inch [1.02 mm] diameter. Female contact - open entry or closed entry design available.
<b>Contact Retention in Insulator:</b>	9 lbs. [40 N]
<b>Contact Termination:</b>	Solder cup - 0.046 inch [1.17 mm] hole diameter for 20 AWG [0.5 mm] wire maximum. Straight printed board mount - 0.030 inch [0.76 mm] termination diameter.
<b>Polarization:</b>	Center post provides polarization of connector.
<b>Mechanical Operations:</b>	Open entry 250 operations Closed entry 500 operations

### ELECTRICAL CHARACTERISTICS:

<b>Contact Current Rating:</b>	7.5 amperes, maximum.
<b>Initial Contact Resistance:</b>	0.008 ohms, maximum.
<b>Clearance and Creepage Distance:</b>	0.039 inch [1.0 mm], minimum.
<b>Working Voltage:</b>	600 VAC (rms).

### CLIMATIC CHARACTERISTICS:

<b>Temperature Range:</b>	-55° to +125° C.
<b>Damp Heat, Steady State:</b>	10 days.



Positronic Industries  
connectpositronic.com

# LGH SERIES

## PROFESSIONAL QUALITY / FIXED CONTACTS

### CIRCLE HEX CONNECTORS

Circle  
Hex

### SOLDER CUP TERMINATION CODE SC

**NOTE:**

Specify contact code "SC" in Step 4 of the ordering information, page 11.

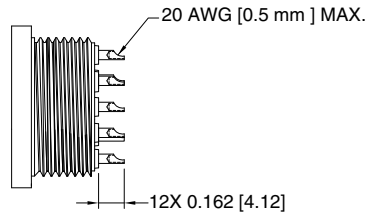

TYPICAL PART NUMBER: LGH12FSC00

### STRAIGHT SOLDER PRINTED BOARD MOUNT TERMINATION CODE DS6

**NOTE:**

Specify contact code "DS6" in Step 4 of the ordering information, page 11.

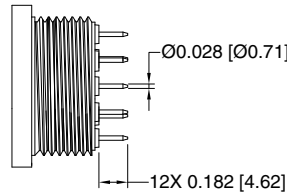

TYPICAL PART NUMBER: LGH12FDS600

### CONTACT HOLE POSITION DIMENSIONS AND PRINTED BOARD MOUNT CONTACT HOLE PATTERN

HOLE IDENTIFICATION SHOWN IS FOR MATING FACE OF FEMALE CONNECTOR.  
USE MIRROR IMAGE FOR MALE CONNECTOR.

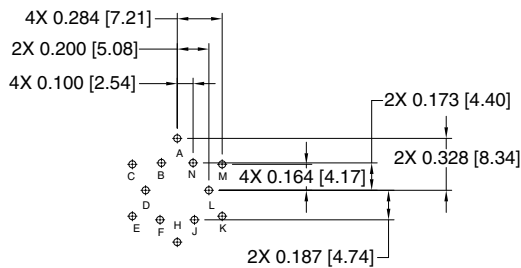

**SUGGESTED PRINTED BOARD HOLE SIZES:**

Suggest 0.045 [1.14] Ø holes in printed board for contact terminations.

### PANEL CUT-OUT DIMENSIONS

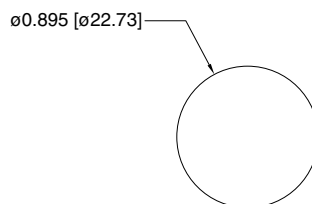



### INSULATOR DIMENSIONS

MATING FACE OF FEMALE CONNECTOR FOR SIZE LGH 12.

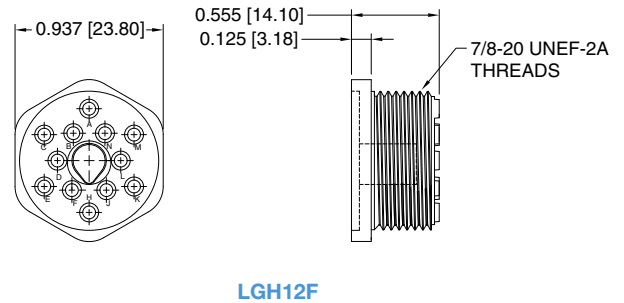
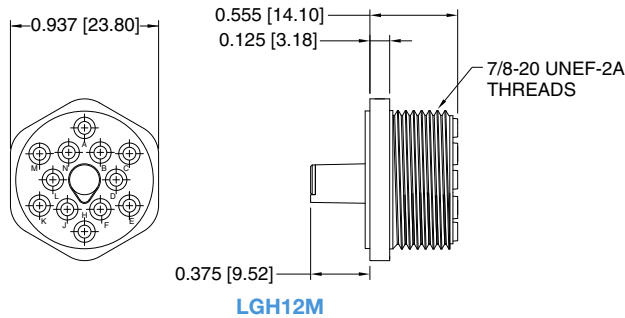

See LGH Series Printed Board Hole Patterns, page 10 of this catalog, for contact variant hole positions.

## ORDERING INFORMATION - CODE NUMBERING SYSTEM

Specify Complete Connector By Selecting An Option From Step 1 Through 6

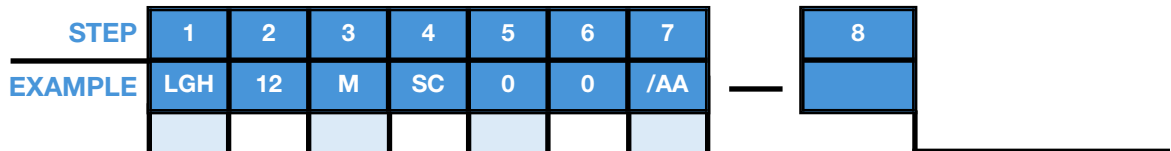

#### STEP 1 - BASIC SERIES

LGH Series

#### STEP 2 - CONNECTOR VARIANTS

12

#### STEP 3 - CONNECTOR GENDER

M - Male  
F - Female - open entry contacts  
FC - Female - closed entry contacts

#### STEP 4 - CONTACT TERMINATION TYPE

SC - Solder Cup.  
DS6 - Straight Solder, 0.182 [4.62]

#### STEP 8 - SPECIAL OPTIONS

CONTACT TECHNICAL SALES  
FOR SPECIAL OPTIONS

#### STEP 7 - ENVIRONMENTAL COMPLIANCE OPTIONS

/AA - Compliant per EU Directive 2002/95/EC (RoHS)



**NOTE:** If compliance to environmental legislation is not required, this step will not be used. Example: LGH12MSC00

#### STEP 6 -

0 - This position is reserved for future use, insert "0".

#### STEP 5 -

0 - This position is reserved for future use, insert "0".

**NOTE:** Once you have made a connector selection, contact Technical Sales if you would like to receive a drawing in DXF, PDF format or a 3-D IGES, STEP, or SOLIDWORKS file.

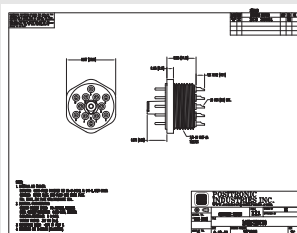

2-D Drawing

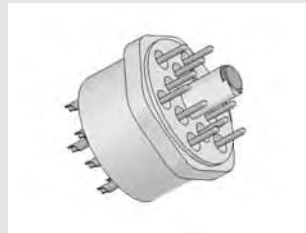

3-D Model



Positronic Industries  
connectpositronic.com

# MGH SERIES

## PROFESSIONAL QUALITY / FIXED CONTACTS

### MICROMINIATURE CIRCLE HEX CONNECTORS

Circle  
Hex

**Size 22 Signal/Power  
Contacts**

**High Performance  
Construction**

**Polarization and  
Locking Accessories**

**UL Recognized  
File #E49351**



MGH series connectors are microminiature, high reliability connectors. They are available with three contacts for providing polarization: two contacts at 0.030 inch [0.76 mm] diameter, and one contact at 0.040 inch [1.02 mm] diameter. The MGH series is rated to 5 amperes per contact. Spacing between contacts is 0.102 inch [2.59 mm], and the face diameter of the connector is 0.312 inch [7.92 mm].

MGH series connectors are ideally applied where limited space is a concern. MGH series connectors

can be used as cable connectors, panel-mounted connectors, or probes. Constructed of high performance materials, MGH series connectors are widely used in medical, industrial, military, and automotive applications.



**For RoHS options  
see page 14.**

## TECHNICAL CHARACTERISTICS

### MATERIALS AND FINISHES:

<b>Insulator:</b>	Glass-filled DAP per ASTM-D-5948, Type SDG-F. Green color is standard.
<b>Contacts:</b>	Precision machined copper alloy.
<b>Contact Plating:</b>	Gold flash over nickel.
<b>Hoods:</b>	Aluminum with yellow or black anodize.
<b>Lock Rings and Lock Springs:</b>	Copper alloy with zinc plate and chromate seal.

### MECHANICAL CHARACTERISTICS:

<b>Fixed Contacts:</b>	Two (2) size 22 contacts, male - 0.030 inch [0.76 mm] diameter, and one (1) size 20 contact, male - 0.040 inch [1.02mm] diameter. Female contact - open entry.
<b>Contact Retention in Insulator:</b>	6 lbs. [26.5 N], minimum.
<b>Contact Termination:</b>	Solder cup - 0.027 inch [0.69mm] hole diameter for 24 AWG [0.25mm <sup>2</sup> ] wire maximum.
<b>Locking Systems:</b>	Friction, lock spring with lock ring.
<b>Polarization:</b>	0.040 inch [1.02 mm] diameter male contact in position "A".
<b>Mechanical Operations:</b>	250 operations per IEC 60512-5.

### ELECTRICAL CHARACTERISTICS:

<b>Contact Current Rating:</b>	5 amperes.
<b>Initial Contact Resistance:</b>	0.012 ohms, maximum.
<b>Flash over Voltage:</b>	1,500 VAC (rms).
<b>Test Voltage:</b>	1,000 VAC (rms).
<b>Insulation Resistance:</b>	5 G ohms, minimum.
<b>Clearance and Creepage Distance:</b>	0.021 inch [0.53 mm], minimum.
<b>Working Voltage:</b>	600 VAC (rms).

### CLIMATIC CHARACTERISTICS:

<b>Temperature Range:</b>	-55°C to +125°C.
<b>Damp Heat, Steady State:</b>	21 days.





**TYPICAL ASSEMBLIES**

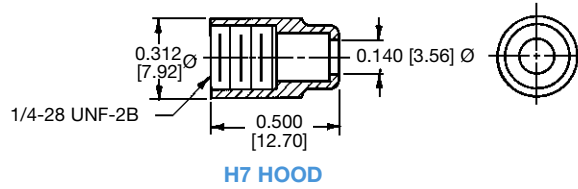
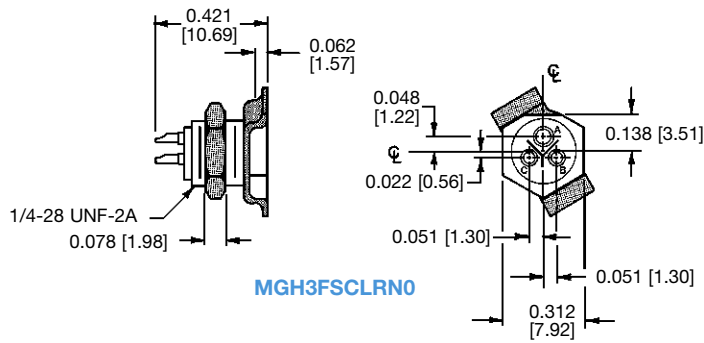
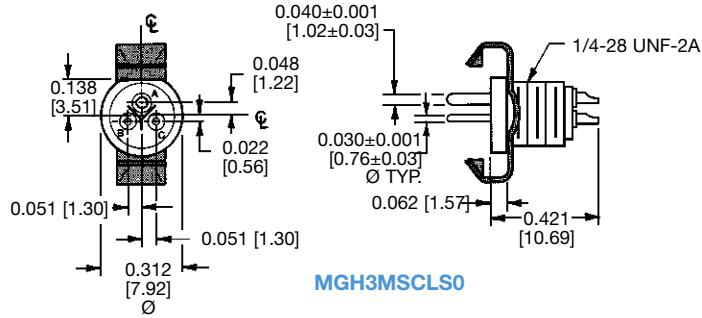

**PANEL CUT-OUT DIMENSIONS**

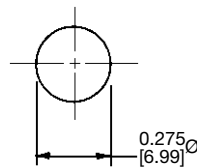



Positronic Industries  
connectpositronic.com

# MGH SERIES

## PROFESSIONAL QUALITY / FIXED CONTACTS

### MICROMINIATURE CIRCLE HEX CONNECTORS

Circle  
Hex

## ORDERING INFORMATION - CODE NUMBERING SYSTEM

Specify Complete Connector By Selecting An Option From Step 1 Through 6

STEP	1	2	3	4	5	6	7	8
EXAMPLE	MGH	3	M	SC	LRN	0	/AA	

### STEP 1 - BASIC SERIES

MGH Series

### STEP 2 - CONNECTOR VARIANTS

3 - Contact Connector Variant

### STEP 3 - CONNECTOR GENDER

M - Male  
F - Female

### STEP 4 - CONTACT TERMINATION TYPE

SC - Solder Cup.

### STEP 5 - MOUNTING AND LOCKING ACCESSORIES

LR - Lock Ring.  
LS - Lock Spring.  
LRN - Lock Ring and Nut.  
0 - If no mounting or locking accessories are required.

### STEP 8 - SPECIAL OPTIONS

**CONTACT TECHNICAL SALES  
FOR SPECIAL OPTIONS**

### STEP 7 - ENVIRONMENTAL COMPLIANCE OPTIONS

/AA - Compliant per EU Directive  
2002/95/EC (RoHS)

**NOTE:** If compliance to environmental  
legislation is not required, this step will  
not be used. Example: MGH3MSCLRNO



### STEP 6 - CABLE ADAPTERS (HOODS)

H7 - Aluminum hood, yellow anodize.  
H7B - Aluminum hood, black anodize.  
0 - If no hoods are required.

**NOTE:** Once you have made a connector selection, contact  
Technical Sales if you would like to receive a drawing in DXF, PDF  
format or a 3-D IGES, STEP, or SOLIDWORKS file.

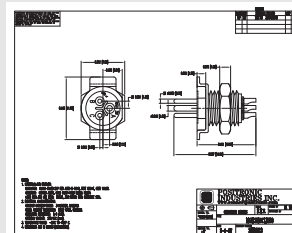

2-D Drawing

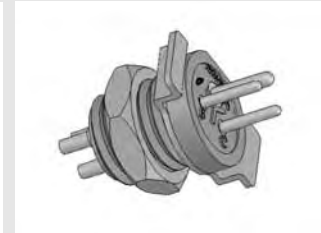

3-D Model

# Connector Excellence<sup>®</sup>

## Positronic HIGH RELIABILITY Products

### POWER



#### FEATURES:

- High current density
- Energy saving - low contact resistance
- AC/DC operation in a single connector
- Signal contacts for hardware management
- Blind mating
- Sequential mating
- Large surface area contact mating system
- Wide variety of accessories
- Customer-specified contact arrangements
- Modular tooling which produces a single piece connector insert

**Contact Sizes:** 0, 8, 12, 16, 20, 22 and 24  
To 200 amperes per contact

**Current Ratings:** Crimp and panel mount, straight solder, right angle (90°) solder, straight compliant press-in and right angle (90°) compliant press-in

**Terminations:** Multiple variants in a variety of package sizes

**Configurations:** MIL-DTL-24308, GSFC S-311-P-4, PICMG 2.11, PICMG 3.0, VITA 41, DSCC, GSFC S-311-P-4, GSFC S-311-P-10

**Compliance:**

### D-SUBMINIATURE



#### FEATURES:

- Four performance levels available for best cost/performance ratio: professional, industrial, military and space-flight quality
- Options include high voltage, coax, thermocouple and air coupling contacts; environmentally sealed and dual port connector packages including mixed density
- Broad selection of accessories
- Size 20 and 22 contacts suitable for use in carrying power
- IP65, IP67

**Contact Sizes:** 8, 16, 20 and 22  
**Current Ratings:** To 100 amperes

**Terminations:** Crimp, wire solder, straight solder, right angle (90°) solder, straight compliant press-in and right angle (90°) compliant press-in

**Configurations:** Multiple variants in both standard and high densities, seven shell sizes

**Qualifications:** MIL-DTL-24308, GSFC S-311-P-4, GSFC S-311-P-10, SAE AS39029, DSCC

### RECTANGULAR



#### FEATURES:

- Two performance levels available: industrial quality and military quality
- A wide variety of accessories
- Broad selection of contact variants and package sizes
- Connector keying options

**Contact Sizes:** 16, 20 and 22  
**Current Ratings:** To 13 amperes nominal

**Terminations:** Crimp, wire solder, straight solder, right angle (90°) solder, and straight compliant press-in

**Configurations:** Multiple variants in both standard and high densities, thirty package sizes

**Qualifications:** MIL-DTL-28748, SAE AS39029, CCITT V,35

### CIRCULAR



#### FEATURES:

- Non-corrodible / lightweight composite construction
- EMI/RFI shielded versions
- Thermocouple contacts
- Environmentally sealed versions
- Rear insertion/ front release of removable contacts
- Two level sequential mating
- Overmolding available on full assemblies

**Contact Sizes:** 12, 16, 20 and 22  
**Current Ratings:** To 25 amperes nominal

**Terminations:** Crimp, wire solder, straight solder, and right angle (90°) solder

**Configurations:** Multiple variants in four package sizes

**Qualifications:** Environmental protection to IP67

### CABLE



#### FEATURES:

- Shorten the supply chain and reduce additional costs and delays by "cabling" your Positronic connector selection
- Overmolding available
- Shielded and environmentally sealed versions available
- Power cables and access boxes which meet the SAE J2496 specification

- ✓ Design assemblies in accordance with customer specifications.
- ✓ Prepare cabled connector configuration and performance specifications.
- ✓ Design each system in accordance with applicable customer, domestic, and international standards.
- ✓ Define and conduct performance and verification testing.

### HERMETIC



#### FEATURES:

- Intended for use as an electrical feedthrough in high vacuum applications
- Leakage rate: 5 x 10<sup>-9</sup> mbar.l/s @ vacuum 1.5 x 10<sup>-5</sup> atm
- Signal, power, coax and high voltage versions available
- Connectors can be mounted on flange assembly per customer specification

**Contact Sizes:** 8, 12, 16, 20 and 22  
**Current Ratings:** To 40 amperes nominal

**Terminations:** Feedthrough is standard; flying leads and board mount available upon request

**Configurations:** See D-subminiature and circular configurations above

**Compliance:** Space-D32

For more information, visit [www.connectpositronic.com](http://www.connectpositronic.com) or call your nearest Positronic sales office listed on the back of this catalog.

## **NORTH AMERICAN LOCATIONS**

### **UNITED STATES, Springfield, Missouri, Corporate Headquarters**

Factory Sales and Engineering Offices 800 641 4054 info@connectpositronic.com

### **PUERTO RICO, Ponce Factory**

Factory Sales and Engineering Offices 800 641 4054 info@connectpositronic.com

### **MEXICO**

Factory Sales and Engineering Offices 800 872 7674 info@connectpositronic.com

### **CANADA**

Factory Sales and Engineering Offices 800 327 8272 info@connectpositronic.com

## **ASIA/PACIFIC LOCATIONS**

### **SINGAPORE, Asia/Pacific Headquarters**

Factory Sales and Engineering Offices 65 6842 1419 singapore@connectpositronic.com

### **ASIA, Direct Sales Offices**

China -Zhuhai Factory and Sales Office 86 756 3626 466 zhuhai@connectpositronic.com  
China -Shenzhen Sales Office 86 755 2643 7578 shenzhen@connectpositronic.com  
China -Shanghai Sales Office 86 158 2907 9779 shanghai@connectpositronic.com  
China -Xian/Beijing Sales Office 86 29 8839 5306 xian@connectpositronic.com  
Korea Sales Office 82 31 909 8047 korea@connectpositronic.com  
Taiwan Sales Office 886 2 2937 8775 taiwan@connectpositronic.com

### **JAPAN, Direct Sales Offices**

Sales and Engineering Offices 81 3 5619 8072 japan@connectpositronic.com

### **INDIA, Direct Sales Offices**

Factory Sales and Engineering Offices 91 20 2439 4810 india@connectpositronic.com  
Bangalore Sales Office 91 94 4907 3251 bangalore@connectpositronic.com  
New Delhi Sales Office 91 80 1071 1175 delhi@connectpositronic.com

### **ASIA/PACIFIC, Technical Agents**

Technical Agents in Malaysia, Australia, New Zealand, Philippines, Hong Kong, Vietnam, Thailand

## **EUROPEAN LOCATIONS**

### **FRANCE, Auch Factory, European Headquarters**

Factory Sales and Engineering Offices 33 5 6263 4491 contact@connectpositronic.com

### **EUROPE, Direct Sales Offices**

Northern France Sales Office 33 1 4588 1388 jchalaux@connectpositronic.com  
Southern France Sales Office 33 5 6263 4491 plafon@connectpositronic.com  
Eire + Northern Ireland 33 5 6263 4557 tauvin@connectpositronic.com  
Italy Sales Office 39 02 5411 6106 rmagni@connectpositronic.com  
Germany Sales Office 49 23 5163 4739 cbouche@connectpositronic.com  
UK Sales Office 44 1242 897493 lbridwell@connectpositronic.com

### **EUROPE, Technical Agents**

Technical Agents in Austria, Benelux, Eastern Europe Countries, Greece, Ireland, Russia, Scandinavia, Spain, Switzerland and the United Kingdom

### **MIDEAST, Technical Agents**

Technical Agents in Israel and Turkey



**POSITRONIC<sup>®</sup>**  
GLOBAL *Connector* SOLUTIONS

### **POSITRONIC INDUSTRIES, INC.**

423 N Campbell Avenue • PO Box 8247 • Springfield, MO 65801  
Tel (417) 866-2322 • Fax (417) 866-4115 • Toll Free (800) 641-4054  
info@connectpositronic.com

### **POSITRONIC INDUSTRIES, S.A.S.**

Zone Industrielle d'Engachies • 46 Route d'Engachies  
France 32020 Auch Cedex 9  
Telephone 33 5 62 63 44 91 • Fax 33 5 62 63 51 17  
contact@connectpositronic.com

### **POSITRONIC ASIA PTE LTD.**

3014A Ubi Road 1 #07-01 • Singapore 408703  
Telephone (65) 6842 1419 • Fax (65) 6842 1421  
singapore@connectpositronic.com

For most current sales office information, please visit [http://www.connectpositronic.com/contact/sales\\_offices.html](http://www.connectpositronic.com/contact/sales_offices.html)

LO+CCATTIONS

www.connectpositronic.com